

W e . s u p p o r t . t h e
i n n o v a t i o n s . o f . c u s t o m e r s

Leak - Proof Flow & Control Solution Partner

The Best Partner
for Value Creation

BITE - DIN 2353 Tube Fittings

HanSun

한선엔지니어링(주)
HANSUN ENGINEERING CO., LTD.





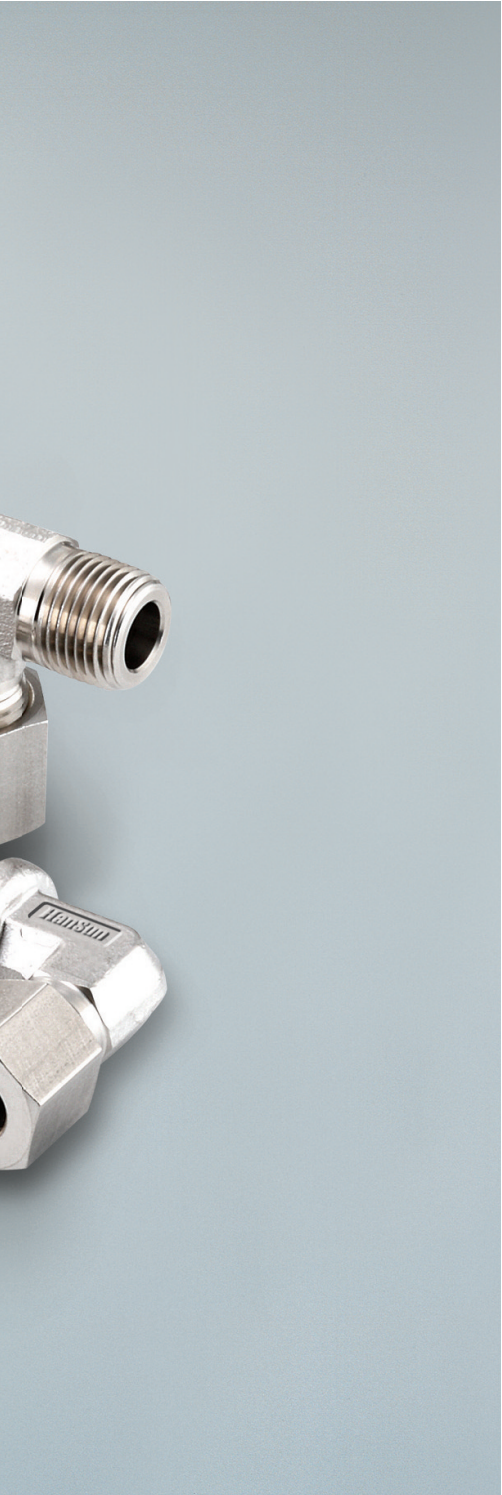
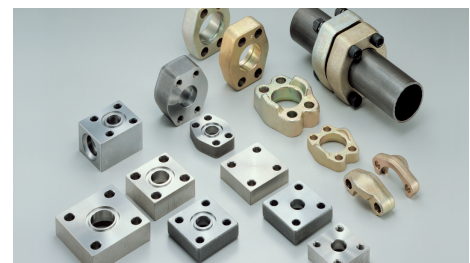
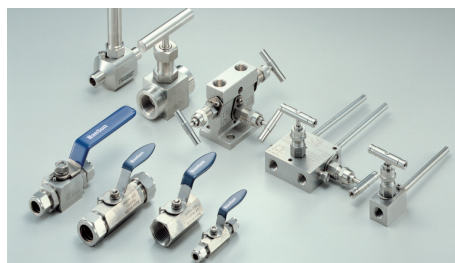

Certificate List



API Spec. Q1



API Monogram



ABS



Lloyd's



KR



DNV



GL



BV



CCS



NK



ECE R110 / ISO / 5500 /
NGV 3.1



Gost - R



Achilles



Achilles FPAL



Achilles JQS

Features

- HANSUN bite type fitting are designed in accordance with DIN 2353.
- The HANSUN bite type fitting is consists of a body, a progressive ring (sleeve) and a nut.
- The HANSUN bite type tube fittings are designed and manufacture to produced a strong, reliable, leak-free joint upon proper assembly.

Standard Material Specifications

- Steel Fittings : Materials see DIN3859.
- Stainless Steel Fitting : X6CrNiMoTi 17122 in accordance with DIN17440, material No. 1.4571. or ASTM A276 / A479 type 316
- Brass Fitting : CuZn35Ni2 in accordance with DIN17660 / 17672, material No. 2.0540.
- Elastomer Seal : NBR(BUNA-N), DIN 17660FPM(VITON).

Information

Pressure and temperature load Capability

- Pressure Ranges

Series	Steel / Brass*		1.4571 (SS316*)	
	Size	Pressure	Size	Pressure
LL	4-8	100 bar	4-8	100 bar
L	6-18	315 bar	6-15	250 bar
	-	-	18-22	160 bar
S	22-42	160 bar	28-42	100 bar
	6-14	630 bar	6-14	630 bar
	16-30	400 bar	16-25	400 bar
	38	315 bar	30-38	315 bar

Brass* : Pressure range of brass should be adapted 30% below of the steel

SS316* : 316 Stainless Steel

Allowable working temperatures

A) For fittings materials

Material	Temperature
Steel	-40°C up to 120°C (DIN 3859)
Brass	-60°C up to 175°C
316 Stainless Steel	-60°C up to 400°C (DIN 17440)

Please refer to the information given in the section "Reduction of Pressure"

Pressure reduction with temperature

The following reduction of pressure compared with the catalogue specification for higher temperatures.

Materials of fittings	Temperature range	Reduction of pressure
Steel	-40°C up to 120°C	-
Brass	-60°C up to 175°C	30%
316 Stainless Steel (1.4571)	-60°C up to 20°C	-
	-60°C up to 50°C	4%
	100°C	11%
	200°C	20%
	300°C	29%
	400°C	33%

For different material of tubes and fittings, the tubes must be tested separately concerning the allowed temperature range and the necessary reduction of pressure.

B) For seal-materials

Material	Temperature
NBR(e.g. Perbunan®)	-35°C up to 110°C
FPM(e.g. Viton®)	-28°C up to 204°C
PTFE(e.g. Teflon®)	-60°C up to 240°C

Caution! If different fitting and sealing material are used, the lowest temperature as indicated for each material is applicable!

Stud Ends & Tapped Hole Forms for tube Fittings

This standard specifies dimensions for stud ends and tapped holes with metric fine pitch thread and pipe thread for use with compression fittings, valves and screw plugs, general outlay of types.

Forms of Stud Ends

Form A (DIN 3852 Part 1+2)
with sealing by washer

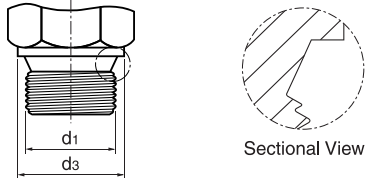

Form B (DIN 3852 Part 1+2)
with sealing by compression
against face of body



Form C (DIN 3852 Part 1+2)
with sealing in tapered thread

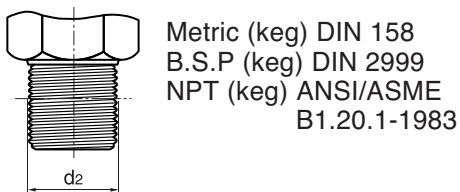

Form E (DIN 3852 Part 1)
with sealing by DIN 3869 ring seals (*ED-Ring)

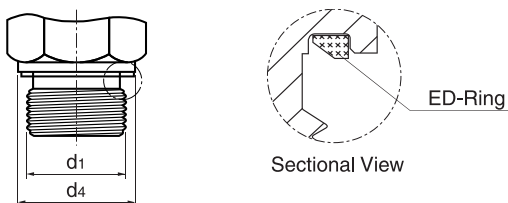

Form F (DIN 3852 Part 3)
with sealing by (*O-Ring)

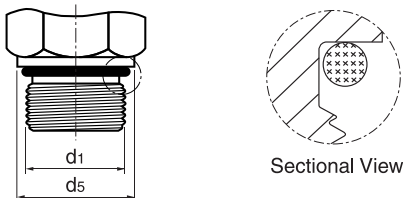

Thread size for		d ₃	d ₄ ⁰ _{-0.2}	d ₅ ±0.1
From A,B and E,F stud ends d ₁	From C stud ends d ₂			
M8X1.0	M8X1.0keg.	-	-	10.9
M10X1.0	M10X1.0keg.	14	13.9	12.9
M12X1.5	M12X1.5keg.	17	16.9	16.9
M14X1.5	M14X1.5keg.	19	18.9	18.9
M16X1.5	M16X1.5keg.	21	21.9	20.9
M18X1.5	M18X1.5keg.	23	23.9	22.9
M20X1.5	M20X1.5keg.	25	25.9	24.9
M22X1.5	M22X1.5keg.	27	26.9	26.9
M26X1.5	-	31	31.9	30.9
M27X2.0	-	32	31.9	31.9
M33X2.0	-	39	39.9	37.9
M42X2.0	-	49	49.9	47.9
M48X2.0	-	55	54.9	54.9
G1/8	1/8 NPT	14	13.9	-
G1/4	1/4 NPT	18	18.9	-
G3/8	3/8 NPT	22	21.9	-
G1/2	1/2 NPT	26	26.9	-
G3/4	3/4 NPT	32	31.9	-
G1	1 NPT	39	39.9	-
G1-1/4	1-1/4 NPT	49	49.9	-
G1-1/2	1-1/2 NPT	55	54.9	-
7/16-20UNF	R1/8keg.	-	-	14.4
9/16-18UNF	R1/4keg.	-	-	17.6
3/4-16UNF	R3/8keg.	-	-	22.3
7/8-14UNF	R1/2keg.	-	-	25.5
1-1/16-12UN	R3/4keg.	-	-	31.9
1-5/16-12UN	R1keg.	-	-	38.2
1-5/8-12UN	R1-1/4keg.	-	-	47.7
-	R1-1/2keg.	-	-	-

* ED-Ring & O-Ring Seals made of NBR Standard (-25°C to 110°C)
Available made of viton® upon request (-28°C to 204°C)

Forms of Tapped Holes

Form X (DIN 3852 Part 1+2)
for parallel Stud Ends. (Form A,B)
*d7 is for Stud Ends Form E

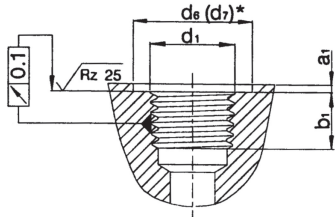

Form Y (DIN 3852 Part 3)
for Stud Ends with O-Ring. (Form F)

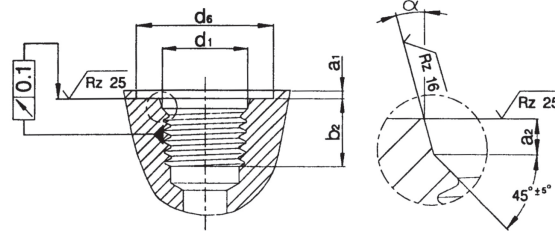

Form Z (DIN 3852 Part 1+2)
for tapered threaded Stud Ends.

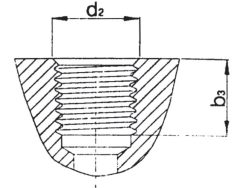

Thread size for		d6 min	d7	a1 max	d2 ^{0,4}	b1 min	b2 min	b3 min	α ± 1.0
From X,Y Tapped Holes d1	From Z Tapped Holes d2								
M8X1.0	M8X1.0keg.	13	-	1.0	1.6	-	10.0	5.5	12
M10X1.0	M10X1.0keg.	15	15	1.0	1.6	8	10.0	5.5	12
M12X1.5	M12X1.5keg.	18	18	1.5	2.4	12	11.5	8.5	12
M14X1.5	M14X1.5keg.	20	20	1.5	2.4	12	11.5	8.5	15
M16X1.5	M16X1.5keg.	22	23	1.5	2.4	12	13.0	8.5	15
M18X1.5	M18X1.5keg.	24	25	2.0	2.4	12	14.5	8.5	15
M20X1.5	M20X1.5keg.	26	27	2.0	2.4	14	14.0	10.5	15
M22X1.5	M22X1.5keg.	28	28	2.5	2.4	14	15.5	10.5	15
M26X1.5	-	32	33	2.5	3.1	16	16.0	-	15
M27X2.0	-	33	33	2.5	3.1	16	19.0	-	15
M33X2.0	-	40	41	2.5	3.1	18	19.0	-	15
M42X2.0	-	50	51	2.5	3.1	20	19.5	-	15
M48X2.0	-	56	56	2.5	3.1	22	22	-	15
G1/8	1/8 NPT	15	15	1.0	-	8	-	6.9	-
G1/4	1/4 NPT	19	20	1.5	-	12	-	10.0	-
G3/8	3/8 NPT	23	23	2.0	-	12	-	10.3	-
G1/2	1/2 NPT	27	28	2.5	-	14	-	13.6	-
G3/4	3/4 NPT	33	33	2.5	-	16	-	14.1	-
G1	1 NPT	40	41	2.5	-	18	-	16.8	-
G1-1/4	1-1/4NPT	50	51	2.5	-	20	-	17.3	-
G1-1/2	1-1/2NPT	56	56	2.5	-	22	-	17.3	-
7/16-20UNF	R1/8 keg.	21	-	1.6	2.4	-	11.5	5.5	12
9/16-18UNF	R1/4 keg.	25	-	1.6	2.5	-	12.7	8.5	12
3/4-16UNF	R3/8 keg.	30	-	2.4	2.5	-	14.3	8.5	15
7/8-14UNF	R1/2 keg.	34	-	2.4	2.5	-	16.7	10.5	15
1-1/16-12UN	R3/4 keg.	41	-	2.4	3.3	-	19.0	13.0	15
1-5/16-12UN	R1 keg.	49	-	3.2	3.3	-	19.0	16.0	15
1-5/8-12UN	R1-1/4 keg.	58	-	3.2	3.3	-	19.0	17.0	15
-	R1-1/2 keg.	-	-	-	-	-	-	17.0	-

Seamless precision stainless steel 1.4571

Stainless steel tubes (e.g. 1.4571), code X6CrNiMoTi 17122, must be cold-drawn and seamless, heat-treated without formation of scales, type m to DIN 17458, provide tolerances to DIN 2391, Part1. The following tube wall thicknesses are suitable for use:

Tube O.D (D)	Tolerance	Wall * Thickness (t)	Weight	Design Pressure DIN 2413	
				I	III
mm	mm	mm	kg/m	bar	bar
4	±0.1	0.75	0.061	391	376
4		1	0.075	500	480
6	±0.1	1	0.125	372	357
6		1.5	0.168	526	505
6		2	0.200	662	637
6		2.25	0.211	725	696
8	±0.1	1	0.175	347	277
8		1.5	0.244	412	396
8		2	0.300	526	505
8		2.5	0.344	630	604
10	±0.1	1	0.225	294	238
10		1.5	0.319	357	343
10		2	0.401	458	439
10		2.5	0.469	551	529
10		3	0.525	638	612
12	±0.08	•1	0.275	245	201
12		1.5	0.394	368	291
12		2	0.501	391	376
12		2.5	0.594	474	455
12		3	0.615	551	529
12		3.5	0.744	624	599
15	±0.08	1.5	0.507	294	238
15		2	0.651	321	309
15		2.5	0.782	391	376
15		3	0.901	458	439
16	±0.08	2	0.701	368	291
16		2.5	0.845	370	355
16		3	0.977	433	416
18	±0.08	•1.5	0.620	245	201
18		2	0.801	327	262
18		2.5	0.967	333	320
18		3	1.126	391	376

Tube O.D (D)	Tolerance	Wall * Thickness (t)	Weight	Design Pressure DIN 2413	
				I	III
mm	mm	mm	kg/m	bar	bar
20	±0.08	2.5	1.095	368	291
20		3	1.277	357	343
20		3.5	1.433	408	392
20		4	1.600	458	439
22	±0.08	•2	1.002	267	218
22		2.5	1.220	334	267
22		3	1.426	328	315
25	±0.08	•2	1.152	235	193
25		2.5	1.408	294	238
25		3	1.635	353	281
25		4	2.092	378	363
25		4.5	2.307	418	402
25	5	2.501	458	439	
28	±0.08	2	1.302	210	174
28		2.5	1.594	263	214
28		3	1.874	315	253
28		4	2.402	342	328
28		5	2.876	415	399
30	±0.08	3	2.028	294	238
30		4	2.605	321	309
30		5	3.400	391	376
35	±0.15	2	1.644	168	141
35		2.5	2.018	210	174
35		3	2.392	252	206
35		4	3.086	336	269
35		5	3.742	342	328
35		6	4.351	401	385
38	±0.15	4	3.405	309	249
38		5	4.131	318	305
38		6	4.807	373	358
38		7	5.426	427	410
42	±0.2	3	2.930	210	174
42		4	3.798	280	227

- Reinforce tube inserts are recommended where thin-walled tubes are subject to severe strains.
- * Permissible variation in wall thickness (DIN 2391)

■ Calculation Pressures:

- Calculated pressures to DIN 2413 part I for primarily static load conditions
- Yield point (K) : 245N/mm² (to DIN 17458)
- Safety factor (S) : 1.5
- Allowance factor (C) :

$$P = \frac{20 \cdot K \cdot t \cdot c}{S \cdot D} \text{ (bar)}$$

- Calculated pressures to DIN 2413 part III for dynamic load conditions
- Yield point (K) : 216N/mm² (assumed value)
- Safety factor (S) : 1.5

$$P = \frac{20 \cdot K \cdot t \cdot c}{S \cdot (D+t \cdot c)} \text{ (bar)}$$

Consideration factors of wall thickness divergence for static and dynamic stress.

Tube Range	4mm/5mm	6mm/8mm	Larger
Factor(C)	0.8	0.85	0.9

■ Note

For a diameter ratio of O.D/I.D>1.35, calculation made to DIN 2413 part III and based on a pulsating fatigue limit of 225 N/mm²

- Temperature range : -60°C to +400°C
- Reduction in pressure for higher temperatures

Ordering Information

<p>Example 1. Tube to Tube Connection</p> <p><u>DDT</u> - <u>12 S</u> - <u>S6</u></p> <p>① ②③ ⑥</p>	<p>Example 2. Tube to Thread Connection</p> <p><u>DDMC</u> - <u>10 L</u> - <u>02G ED</u> - <u>S6</u></p> <p>① ②③ ④ ⑤ ⑥</p>
<p>Example 3. Tube to Tube Port</p> <p><u>DDEW</u> - <u>16 S</u> - <u>S6</u></p> <p>① ②③ ⑥</p>	<p>Example 4. Tube Port to Female Port</p> <p><u>DDMGE</u> - <u>16 S</u> - <u>04G ED</u> - <u>CS</u></p> <p>① ②③ ④ ⑤ ⑥</p>
<p>Example 5. Banjo Fitting</p> <p><u>DDWH</u> - <u>16 S</u> - <u>04G</u> - <u>S6</u></p> <p>① ②③ ④ ⑥</p>	<p>Example 6. Male / Female Adaptor</p> <p><u>DMFAE</u> <u>04G - 03G</u> - <u>CS</u></p> <p>① ④ ⑥</p>

① Name of Fitting : "Refer to Index"
 ② Tube O.D : See Tube O.D Designator
 ③ Series : See Series Designator
 ④ Thread Connection : See Thread Designator
 ⑤ Elastomer Seal : ED-Ring (Refer to seal materials)
 ⑥ Material : See Material Designator

• Tube O.D Designator

Tube O.D	4mm	6mm	8mm	38mm	42mm
Identifier	04	06	08	38	42

• Series Designator

Series	Very Light	Light	Heavy
Identifier	LL	L	S

• Thread Designator (Pipe Thread)

Nominal Size		1/8"	1/4"	3/8"	1/2"	3/4"	1"	1-1/4"	1-1/2"
Identifier	ANSI/ASME 1.20.1-1983 NPT	01N	02N	03N	04N	06N	08N	10N	12N
	DIN-ISO228(DIN 259) BSP/Parallel	01G	02G	03G	04G	06G	08G	10G	12G
	DIN-2999 BSP Tapered	01R	02R	03R	04R	06R	08R	10R	12R

• Thread Designator (Metric Thread)

Metric Size		M8x1.0	M10x1.0	M12x1.5	M14x1.5	M27x2.0	M33x2.0	M42x2.0	M48x2.0
Identifier	DIN158 Taper (keg)	M8K	M10K	M12K	M14K				
	DIN-13 Parallel	M8	M10	M12	M12	M27	M33	M42	M48

• Thread Designator (Unified)

Size	7/16-20UNF	9/16-18UNF	3/4-16UNF	7/8-14UNF	1 1/16-12UN	1 5/16-12UN	1 5/8-12UN
Identifier	04U	06U	08U	10U	12U	16U	20U

• Material Designator

Material	Carbon Steel (DIN 3859)	Stainless Steel	Brass
		DIN 17440 / 1.4571 or ASTM A276 / A479 TYPE 316	
Identifier	CS	S6	BS

Tube to Tube		Page	Hy-Lok	EO	EMB	VOLZ	VOSS	WALPRO
	DDU Straight Union	13	DU	G	E	G-V	111... 112...	P-GV
	DDL Union Elbow	13	DL	W	F	W-V	119... 120...	P-WV
	DDUR Reducing Union	14	DUR	GR		GR-V		P-GV
	DDT Union Tee	15	DT	T	G	T-V	133... 134...	P-TV
	DDC Union Cross	15	DC	K	H	K-V	135... 136...	P-KV
	DDTR Reducing Tee	16	DTR	TR				P-TV
	DBBU Bulkhead Union	17	DBU	SV	K	GS-V	137...	P-GSV
	DBBUW Welding Bulkhead Union	17	DBUW	ESV	N	ES-V	141...	P-ESV
	DBBL Bulkhead Union Elbow	18	DBL	WSV	L	WS-V	138...	P-WSV

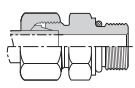
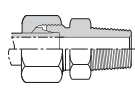
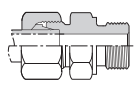
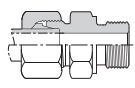
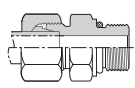
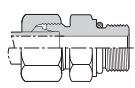
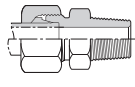
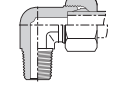
Tube to Female Port		Page	Hy-Lok	EO	EMB	VOLZ	VOSS	WALPRO
	DDOM-U/M Male Connector (UNF/Metric) with O-Ring	19	DOM-U/M	GE-UNF/UN GEO			182...	P-GEV..U P-GEV..M-FO.F
	DDMC-R Male Connector (BSP Tapered)	20,21	DMC-R	GE-R	AP-R	GE-V..RK	103... 104...	P-GEV..RK
	DDMC-G Male Connector (BSP Paralled)	20,21	DMC-G	GE-R	A-R	GR-V..R	110...	P-GEV..R
	DDMC-M Male Connector (Metric Paralled)	22	DMC-M	GE-M	A-M	GR-V..M	109...	P-GEV..M
	DDMC-GED Male Connector (BSP Paralled) with ED-Ring	23	DMC-GED	GE-R-ED	A-RWD	GE-V..RWD	184...	P-GEV..R-WD
	DDMC-MED Male Connector with ED-Ring	24	DMC-MED	GE-M-ED	A-MWD	GE-V..MWD	184...	P-GEV..M-WD
	DDMC-N Male Connector (NPT Thread)	25	DMC-N	GE-NPT	A/NPT	GE-V..NPT	105...106	P-GEV..NPT
	DDLM-R/M Male Elbow (BSP Tapered/Metric Tapered)	25	DLM-R/M	WE-R-M	B-R-M	WE-V..R..M	115... 116... 113... 114...	P-WEV..RK ..MK

Tube to Male Thread Page Hy-Lok EO EMB VOLZ VOSS WALPRO

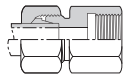

DDFC-G/M
Female Connector
(BSP Paralled/Metric Paralled)

26 DFC-G/M GAI-R -M AL-R -M GAIV..R ..M 144... 143... P-GAV..R ..M

Tube to Tube Port (Adjustable Fittings) Page Hy-Lok EO EMB VOLZ VOSS WALPRO

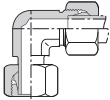

DDLA
Adjustable Elbow
with Standpipe

27 DLA EVW vb EW-V 158... P-EWv-SV

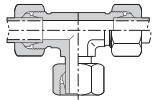

DDBTA
Adjustable Branch Tee
with Standpipe

27 DBTA EVT vc ET-V 160... P-ETV-SV

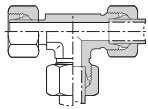

DDRTA
Adjustable Run Tee
with Standpipe

28 DRTA EVL vd EL-V 162... P-ELV-SV

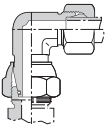

DDEW
Swivel Adjustable Elbow
with Cone

28 DEW EW VBDKO EWVD P-EWVD

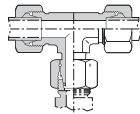

DDET
Swivel Adjustable Branch Tee
with Cone

29 DET ET VCDKO ETVD P-ETVD

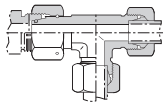

DDEL
Swivel Adjustable Run Tee
with Cone

29 DEL EL VDDKO ELVD P-ELVD

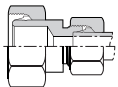

DDKOR
Standpipe Reducer

30 DKOR KOR RL,RS

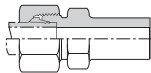

DDR
Reducer

31 DR KOR-V 148...78 P-REDV-SV

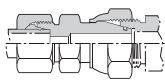

DDRED
Swivel Reducing Adaptor
with Cone

32 DRED RED RLDKO RSDKO REDV P-REDVD

Tube Port to Female Port Page Hy-Lok EO EMB VOLZ VOSS WALPRO

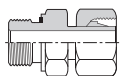

DDA-GED/MED
Adaptor
(BSP Paralled/Metric Paralled)
with ED-Ring

33 DA-GED/MED EVGE-R-ED -M-ED VA-Rwd -Mwd EG-V..RWD ..MWD 177... 174... P-EGES..R-WD-SV ..M-WD-SV

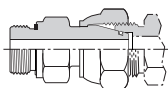

DDEGE-G/M
Swivel Adaptor
(BSP Paralled/Metric Paralled)
with ED-Ring

34 DEGE-G/M EGE-R-ED -M-ED VADKO-Rwd -Mwd EGVD..RWD ..MWD EGESD..R-WD ..M..WD

Tube Port to Tube Port Page Hy-Lok EO EMB VOLZ VOSS WALPRO

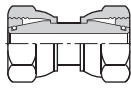

DDUE
Swivel Union
with Cone

35 DUE EDKO EDKV SNV

Banjo Fittings Page Hy-Lok EO EMB VOLZ VOSS WALPRO

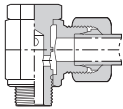

DDSWVE-G/M
Banjo Fittings
(BSP Paralled/Metric Paralled)
with DKA-Ring

36 DSWVE-G/M SWVE-R SBD-R
-M -M 152.../153...
150.../151...

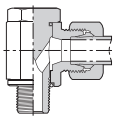

DDWH-G/M
High Pressure Banjo Fittings
(BSP Paralled/Metric Paralled)
with DKA-Ring

37 DWH-G/M SBE-R EWHV-...R 157... P-RSWV...R
-M -...M 155... ..M

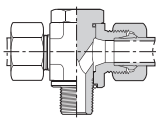

DDTH-G/M
High Pressure Banjo Fittings
(BSP Paralled/Metric Paralled)

38 DTH-G/M ETHV-...R P-RSTV...R
-...M ..V

Gauge connector & Test couplings Page Hy-Lok EO EMB VOLZ VOSS WALPRO

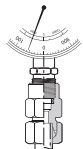

DDGC-G
Pressure Gauge Connector
(BSP Paralled)
with DKI-Ring

39 DGC-G MVA O MA-V...R 142... V-MAV...R

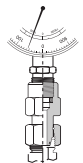

DDGE-G
Swivel Gauge Adaptor
(BSP Paralled)
with Cone and DKI-Ring

39 DGE-G MAVE VODKO MAVD...R EMASD...

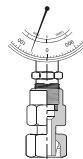

DDGA-G
Gauge Connector
(BSP Paralled)
with Standpipe and DKI-Ring

39 DGA-G MAEV...R P-EMAS...R
-SV

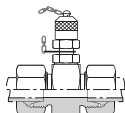



DDGMA
Tee Test Coupling
with Threaded Connection
DEMA 3-02G

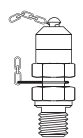

40 DGMA GMA3



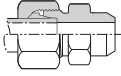

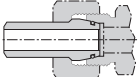
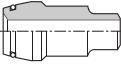

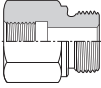
DDEMA3
Test Coupling
with Threaded Connection M16

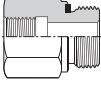
40 DEMA3 EMA3

Weld Fittings		Page	Hy-Lok	EO	EMB	VOLZ	VOSS	WALPRO
	DDAS Welding Connector	41	DAS	AS	V	GAS-V	139...	P-ASV
	DDASK Welding Connector with DAK	41	DASK	ASK	ESNO	ASKK..OD		
	DDAK Welding Nipple with O-Ring	42	DAK	SKA	SNO	SK-A..OD	070...	SN
	DDAKR Reducing Welding Nipple with O-Ring	42	DAKR	SKAR	SNR			

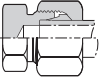
Adaptor		Page	Hy-Lok	EO	EMB	VOLZ	VOSS	WALPRO
	DMFAD Male Female Adaptor (BSP Parallel)	44	MFAD					
	DMFAE Male Female Adaptor (BSP Parallel)	44	MFAE					
	DMFAD-ED Male Female Adaptor (BSP Parallel) with ED-Ring	45	MFAD-ED					
	DMFAE-ED Male Female Adaptor (BSP Parallel) with ED-Ring	45	MFAE-ED					

Plugs and Caps		Page	Hy-Lok	EO	EMB	VOLZ	VOSS	WALPRO
	DDVSTI-GED/MED Blanking Plugs for Port with ED-Ring	46	DVSTI-GED/MED	VSIT R-ED M-ED	VSCH -Rwd -Mwd	VSCH..WD	189...	VS-R-WD -M-WD
	DDVSTI Blanking Plugs with O-Ring (accord.to ISO 6149-3/DIN 3582)	46	DVSTI	VSIT M-OR				
	DDVKA Blanking Plug with O-Ring	47	DVKA	VKA	STO-O	VSTO..OD		VS...
	DDCA Tube Cap	47	DCA	ROV	VSCHK	EVSV		

Spare parts		Page	Hy-Lok	EO	EMB	VOLZ	VOSS	WALPRO
	DDN Nut	48	DN	M	m	U-M	004	P-GAV..R ..M
	DDS Cutting Ring	48	DS	DPR	S	S-DR	007...	S-R P-R

DDU

Straight Union

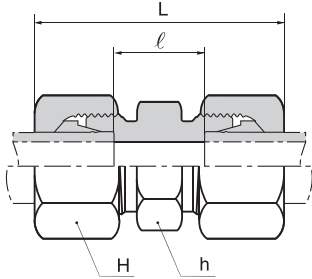

Series	Part No.	Tube O.D.	H	h	L	l
LL Very Light PN 100	DDU-04LL	4	10	9	31	12
	DDU-06LL	6	12	11	32	9
	DDU-08LL	8	14	12	35	12
	DDU-10LL	10	17	14	35	12
	DDU-12LL	12	19	17	35	11
L Light PN 315	DDU-06L	6	14	12	39	10
	DDU-08L	8	17	14	40	11
	DDU-10L	10	19	17	42	13
	DDU-12L	12	22	19	43	14
	DDU-15L	15	27	24	46	16
PN 160	DDU-22L	22	36	32	52	20
	DDU-28L	28	41	41	54	21
	DDU-35L	35	50	46	63	20
	DDU-42L	42	60	55	66	21
S Heavy PN 630	DDU-06S	6	17	14	45	16
	DDU-08S	8	19	17	47	18
	DDU-10S	10	22	19	49	17
	DDU-12S	12	24	22	51	19
	DDU-14S	14	27	24	57	22
PN 400	DDU-16S	16	30	27	57	21
	DDU-20S	20	36	32	66	23
	DDU-25S	25	46	41	74	26
	DDU-30S	30	50	46	80	27
PN 315	DDU-38S	38	60	55	90	29

DDL

Union Elbow

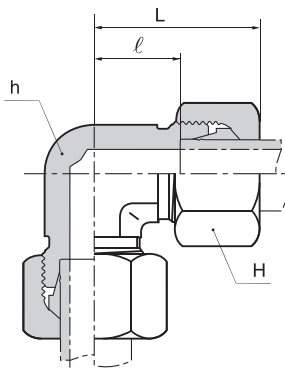

Series	Part No.	Tube O.D.	H	h	L	l
LL Very Light PN 100	DDL-04LL	4	10	9	21	11
	DDL-06LL	6	12	9	21	9.5
	DDL-08LL	8	14	12	23	11.5
	DDL-10LL	10	17	14	24	12.5
	DDL-12LL	12	19	17	25	13
L Light PN 315	DDL-06L	6	14	12	27	12
	DDL-08L	8	17	12	29	14
	DDL-10L	10	19	14	30	15
	DDL-12L	12	22	17	32	17
	DDL-15L	15	27	19	36	21
PN 160	DDL-22L	22	36	27	44	27.5
	DDL-28L	28	41	36	47	30.5
	DDL-35L	35	50	41	56	34.5
	DDL-42L	42	60	50	63	40
S Heavy PN 630	DDL-06S	6	17	12	31	16
	DDL-08S	8	19	14	32	17
	DDL-10S	10	22	17	34	17.5
	DDL-12S	12	24	17	38	21.5
	DDL-14S	14	27	19	40	22
PN 400	DDL-16S	16	30	24	43	24.5
	DDL-20S	20	36	27	48	26.5
	DDL-25S	25	46	36	54	30
	DDL-30S	30	50	41	62	35.5
PN 315	DDL-38S	38	60	50	72	41

Dimensions given approximate length with tightened nut. All dimensions are in millimeters, for reference only subject to change.

DDUR

Reducing Union

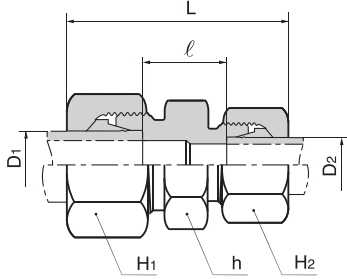

Series	Part No.	Tube O.D.		H ₁	H ₂	h	L	ℓ
		D ₁	D ₂					
L Light PN 315	DDUR-08L-06L	8	6	17	14	14	40	11
	DDUR-10L-06L	10	6	19	14	17	41	12
	DDUR-10L-08L	10	8	19	17	17	41	12
	DDUR-12L-06L	12	6	22	14	19	42	13
	DDUR-12L-08L	12	8	22	17	19	42	13
	DDUR-12L-10L	12	10	22	19	19	43	14
	DDUR-15L-10L	15	10	27	19	24	45	15
	DDUR-15L-12L	15	12	27	22	24	45	15
	DDUR-18L-10L	18	10	32	19	27	46	15.5
	DDUR-18L-12L	18	12	32	22	27	46	15.5
PN 160	DDUR-18L-15L	18	15	32	27	27	48	16.5
	DDUR-22L-12L	22	12	36	22	32	48	17.5
	DDUR-22L-15L	22	15	36	27	32	50	18.5
	DDUR-22L-18L	22	18	36	32	32	50	18
	DDUR-28L-18L	28	18	41	32	41	52	19
	DDUR-28L-22L	28	22	41	36	41	54	21
	DDUR-35L-22L	35	22	50	36	46	59	21
S Heavy PN 630	DDUR-35L-28L	35	28	50	41	46	59	21
	DDUR-08S-06S	8	6	19	17	17	47	18
	DDUR-10S-06S	10	6	22	17	19	48	17.5
	DDUR-10S-08S	10	8	22	19	19	48	17.5
	DDUR-12S-06S	12	6	24	17	22	50	19.5
	DDUR-12S-08S	12	8	24	19	22	50	19.5
	DDUR-12S-10S	12	10	24	22	22	51	19
	DDUR-14S-10S	14	10	27	22	24	54	20.5
PN 400	DDUR-14S-12S	14	12	27	24	24	54	20.5
	DDUR-16S-12S	16	12	30	24	27	54	20
	DDUR-16S-14S	16	14	30	27	27	57	21.5
	DDUR-20S-10S	20	10	36	22	32	60	22
	DDUR-20S-12S	20	12	36	24	32	60	22
	DDUR-20S-16S	20	16	36	30	32	63	23
	DDUR-25S-16S	25	16	46	30	41	68	25
	DDUR-25S-20S	25	20	46	36	41	71	25.5
PN 315	DDUR-30S-20S	30	20	50	36	46	74	26
	DDUR-30S-25S	30	25	50	46	46	77	26.5
PN 315	DDUR-38S-30S	38	30	60	50	55	87	29.5

Dimensions given approximate length with tightened nut. All dimensions are in millimeters, for reference only subject to change.

DDT

Union Tee

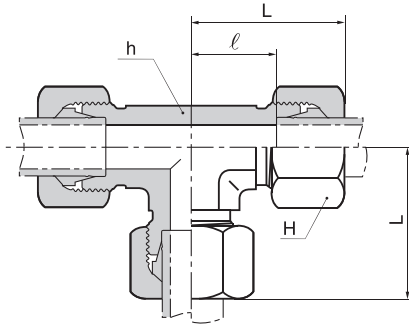

Series	Part No.	Tube O.D	H	h	L	l
LL Very Light PN 100	DDT-04LL	4	10	9	21	11
	DDT-06LL	6	12	9	21	9.5
	DDT-08LL	8	14	12	23	11.5
	DDT-10LL	10	17	14	24	12.5
	DDT-12LL	12	19	14	27	15
L Light PN 315	DDT-06L	6	14	12	27	12
	DDT-08L	8	17	12	29	14
	DDT-10L	10	19	14	30	15
	DDT-12L	12	22	17	32	17
	DDT-15L	15	27	19	36	21
PN 160	DDT-18L	18	32	24	40	23.5
	DDT-22L	22	36	27	44	27.5
	DDT-28L	28	41	36	47	30.5
	DDT-35L	35	50	41	56	34.5
S Heavy PN 630	DDT-42L	42	60	50	63	40
	DDT-06S	6	17	12	31	16
	DDT-08S	8	19	14	32	17
	DDT-10S	10	22	17	34	17.5
	DDT-12S	12	24	17	38	21.5
PN 400	DDT-14S	14	27	19	40	22
	DDT-16S	16	30	24	43	24.5
	DDT-20S	20	36	27	48	26.5
	DDT-25S	25	46	36	54	30
PN 315	DDT-30S	30	50	41	62	35.5
	DDT-38S	38	60	50	72	41

DDC

Union Cross

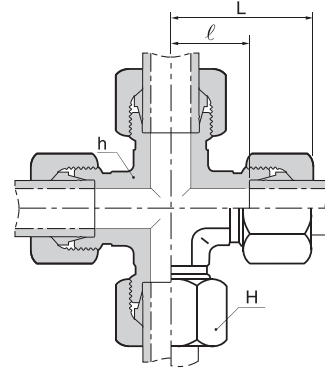

Series	Part No.	Tube O.D	H	h	L	l
LL Very Light PN 100	DDC-04LL	4	10	9	21	11
	DDC-06LL	6	12	9	21	9.5
	DDC-08LL	8	14	12	23	11.5
	DDC-10LL	10	17	14	24	12.5
	DDC-12LL	12	19	14	27	15
L Light PN 315	DDC-06L	6	14	12	27	12
	DDC-08L	8	17	12	29	14
	DDC-10L	10	19	14	30	15
	DDC-12L	12	22	17	32	17
	DDC-15L	15	27	19	36	21
PN 160	DDC-18L	18	32	24	40	23.5
	DDC-22L	22	36	27	44	27.5
	DDC-28L	28	41	36	47	30.5
	DDC-35L	35	50	41	56	34.5
S Heavy PN 630	DDC-42L	42	60	50	63	40
	DDC-06S	6	17	12	31	16
	DDC-08S	8	19	14	32	17
	DDC-10S	10	22	17	34	17.5
	DDC-12S	12	24	17	38	21.5
PN 400	DDC-14S	14	27	19	40	22
	DDC-16S	16	30	24	43	24.5
	DDC-20S	20	36	27	48	26.5
	DDC-25S	25	46	36	54	30
PN 315	DDC-30S	30	50	41	62	35.5
	DDC-38S	38	60	50	72	41

Dimensions given approximate length with tightened nut. All dimensions are in millimeters, for reference only subject to change.

DDTR

Reducing Tee

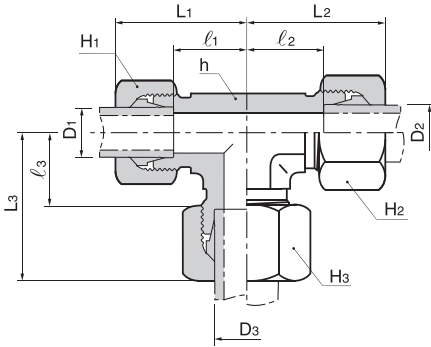

Series	Part No.	Tube O.D.			H ₁	H ₂	H ₃	h	L ₁	L ₂	L ₃	l ₁	l ₂	l ₃
		D ₁	D ₂	D ₃										
L Light PN 316	DDTR-06L-06L-08L	6	6	8	14	14	17	14	29	29	29	14	14	14
	DDTR-08L-08L-06L	8	8	6	17	17	14	14	29	29	29	14	14	14
PN 315	DDTR-06L-06L-10L	6	6	10	14	14	19	14	30	30	30	15	15	15
	DDTR-08L-08L-10L	8	8	10	17	17	19	14	30	30	30	15	15	15
	DDTR-10L-10L-06L	10	10	6	19	19	14	14	30	30	30	15	15	15
	DDTR-10L-10L-08L	10	10	8	19	19	17	14	30	30	30	15	15	15
	DDTR-10L-06L-10L	10	6	10	19	14	19	14	30	30	30	15	15	15
PN 315	DDTR-08L-08L-12L	8	8	12	17	17	22	17	32	32	32	17	17	17
	DDTR-12L-12L-06L	12	12	6	22	22	14	17	32	32	32	17	17	17
	DDTR-12L-08L-08L	12	8	8	22	17	17	17	32	32	32	17	17	17
	DDTR-12L-12L-08L	12	12	8	22	22	17	17	32	32	32	17	17	17
	DDTR-12L-10L-10L	12	10	10	22	19	19	17	32	32	32	17	17	17
	DDTR-12L-12L-10L	12	12	10	22	22	19	17	32	32	32	17	17	17
	DDTR-12L-10L-12L	12	10	12	22	19	22	17	32	32	32	17	17	17
PN 315	DDTR-10L-10L-15L	10	10	15	19	19	27	19	36	36	36	21	21	21
	DDTR-12L-12L-15L	12	12	15	22	22	27	19	36	36	36	21	21	21
	DDTR-15L-15L-06L	15	15	6	27	27	14	19	36	36	36	21	21	21
	DDTR-15L-15L-10L	15	15	10	27	27	19	19	36	36	36	21	21	21
	DDTR-15L-15L-12L	15	12	12	27	22	22	19	36	36	36	21	21	21
	DDTR-15L-15L-12L	15	15	12	27	27	22	19	36	36	36	21	21	21
	DDTR-15L-12L-15L	15	12	15	27	22	27	19	36	36	36	21	21	21
PN 315	DDTR-12L-12L-18L	12	12	18	22	22	32	24	39	39	40	24	24	23.5
	DDTR-18L-10L-10L	18	10	10	32	19	19	24	40	39	39	23.5	24	24
	DDTR-18L-18L-10L	18	18	10	32	32	19	24	40	40	39	23.5	23.5	24
	DDTR-18L-18L-12L	18	18	12	32	32	22	24	40	40	39	23.5	23.5	24
	DDTR-18L-18L-15L	18	18	15	32	32	27	24	40	40	39	23.5	23.5	24
	DDTR-18L-10L-18L	18	10	18	32	19	32	24	40	39	40	23.5	24	23.5
PN 160	DDTR-22L-22L-10L	22	22	10	36	36	19	27	44	44	43	27.5	27.5	28
	DDTR-22L-22L-12L	22	22	12	36	36	22	27	44	44	43	27.5	27.5	28
	DDTR-22L-15L-15L	22	15	15	36	27	27	27	44	43	43	27.5	28	28
	DDTR-22L-22L-15L	22	22	15	36	36	27	27	44	44	43	27.5	27.5	28
	DDTR-22L-18L-18L	22	18	18	36	32	32	27	44	44	44	27.5	27.5	27.5
	DDTR-22L-22L-18L	22	22	18	36	36	32	27	44	44	44	27.5	27.5	27.5
	DDTR-22L-18L-22L	22	18	22	36	32	36	27	44	44	44	27.5	27.5	27.5
PN 160	DDTR-28L-28L-10L	28	28	10	41	41	19	36	47	47	46	30.5	30.5	31
	DDTR-28L-28L-12L	28	28	12	41	41	22	36	47	47	46	30.5	30.5	31
	DDTR-28L-28L-15L	28	28	15	41	41	27	36	47	47	46	30.5	30.5	31
	DDTR-28L-28L-18L	28	28	18	41	41	32	36	47	47	47	30.5	30.5	30.5
	DDTR-28L-22L-22L	28	22	22	41	36	36	36	47	47	47	30.5	30.5	30.5
	DDTR-28L-28L-22L	28	28	22	41	41	36	36	47	47	47	30.5	30.5	30.5
S Heavy PN 630	DDTR-10S-10S-06S	10	10	6	22	22	17	17	34	34	33	17.5	17.5	18
	DDTR-12S-08S-08S	12	8	8	24	19	19	17	38	37	37	21.5	22	22
	DDTR-12S-12S-08S	12	12	8	24	24	19	17	38	38	37	21.5	21.5	22
PN 400	DDTR-12S-12S-10S	12	12	10	24	24	22	17	38	38	38	21.5	21.5	21.5
	DDTR-12S-12S-16S	12	12	16	24	24	30	24	42	42	43	25.5	25.5	24.5
	DDTR-16S-16S-06S	16	16	6	30	30	17	24	43	43	41	24.5	24.5	26
	DDTR-16S-16S-08S	16	16	8	30	30	19	24	43	43	41	24.5	24.5	26
PN 400	DDTR-16S-16S-10S	16	16	10	30	30	22	24	43	43	42	24.5	24.5	25.5
	DDTR-16S-16S-12S	16	16	12	30	30	24	24	43	43	42	24.5	24.5	25.5
	DDTR-16S-16S-20S	16	16	20	30	30	36	27	47	47	48	28.5	28.5	26.5
PN 400	DDTR-20S-20S-10S	20	20	10	36	36	22	27	48	48	46	26.5	26.5	29.5
	DDTR-20S-20S-12S	20	20	12	36	36	24	27	48	48	46	26.5	26.5	29.5
	DDTR-20S-20S-16S	20	20	16	36	36	30	27	48	48	47	26.5	26.5	28.5
PN 400	DDTR-20S-20S-25S	20	20	25	36	36	46	36	53	53	54	31.5	31.5	30
	DDTR-25S-25S-16S	25	25	16	46	46	30	36	54	54	52	30	30	33.5
PN 400	DDTR-25S-25S-20S	25	25	20	46	46	36	36	54	54	53	30	30	31.5
	DDTR-25S-25S-30S	25	25	30	46	46	50	41	61	61	62	37	37	35.5

Dimensions given approximate length with tightened nut. All dimensions are in millimeters, for reference only subject to change.

DDBU

Bulkhead Union

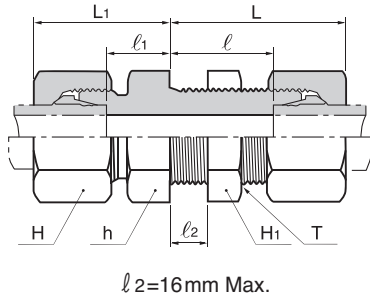

Series	Part No.	Tube O.D.	H	H ₁	h	L	L ₁	l	l ₁	T
L Light PN 315	DDBU-06L	6	14	17	17	42	22	27	7	M12 x 1.5
	DDBU-08L	8	17	19	19	42	23	27	8	M14 x 1.5
	DDBU-10L	10	19	22	22	43	25	28	10	M16 x 1.5
	DDBU-12L	12	22	24	24	44	25	29	10	M18 x 1.5
	DDBU-15L	15	27	30	27	46	27	31	12	M22 x 1.5
	DDBU-18L	18	32	36	32	49	30	32.5	13.5	M26 x 1.5
PN 160	DDBU-22L	22	36	41	36	51	33	34.5	16.5	M30 x 2
	DDBU-28L	28	41	46	41	52	35	35.5	18.5	M36 x 2
	DDBU-35L	35	50	55	50	58	40	36.5	18.5	M45 x 2
	DDBU-42L	42	60	65	60	59	42	36	19	M52 x 2
S Heavy PN 630	DDBU-06S	6	17	19	19	44	27	29	12	M14 x 1.5
	DDBU-08S	8	19	22	22	44	28	29	13	M16 x 1.5
	DDBU-10S	10	22	24	24	46	31	29.5	14.5	M18 x 1.5
	DDBU-12S	12	24	27	27	47	31	30.5	14.5	M20 x 1.5
	DDBU-14S	14	27	30	30	50	35	32	17	M22 x 1.5
PN 400	DDBU-06S	16	30	32	32	50	35	31.5	16.5	M24 x 1.5
	DDBU-20S	20	36	41	41	55	39	33.5	17.5	M30 x 2
	DDBU-25S	25	46	46	46	59	44	35	20	M36 x 2
PN 315	DDBU-30S	30	50	50	50	64	48	37.5	21.5	M42 x 2
	DDBU-38S	38	60	65	65	68	53	37	22	M52 x 2

Dimensions given approximate length with tightened nut. All dimensions are in millimeters, for reference only subject to change.

DDBUW

Welding Bulkhead Union

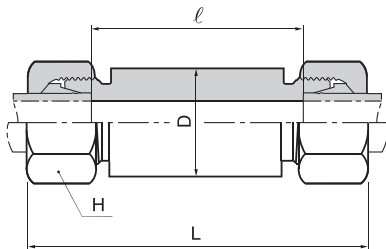

Series	Part No.	Tube O.D.	D	H	L	l
L Light PN 315	DDBUW-06L	6	18	14	85	56
	DDBUW-08L	8	20	17	85	56
	DDBUW-10L	10	22	19	87	58
	DDBUW-12L	12	25	22	87	58
	DDBUW-15L	15	28	27	100	70
	DDBUW-18L	18	32	32	101	69
PN 315	DDBUW-22L	22	36	36	105	73
	DDBUW-28L	28	40	41	106	73
	DDBUW-35L	35	50	50	114	71
	DDBUW-42L	42	60	60	115	70
S Heavy PN 630	DDBUW-06S	6	20	17	89	60
	DDBUW-08S	8	22	19	89	60
	DDBUW-10S	10	25	22	91	59
	DDBUW-12S	12	28	24	91	59
	DDBUW-14S	14	30	27	107	72
PN 400	DDBUW-16S	16	35	30	107	71
	DDBUW-20S	20	38	36	114	71
	DDBUW-25S	25	45	46	120	72
	DDBUW-30S	30	50	50	126	73
PN 315	DDBUW-38S	38	60	60	133	72

Dimensions given approximate length with tightened nut. All dimensions are in millimeters, for reference only subject to change.

DDBL

Bulkhead Union Elbow

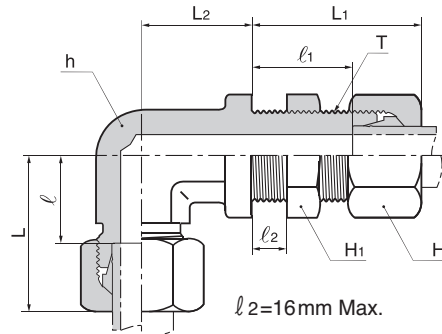

Series	Part No.	Tube O.D.	H	H ₁	h	L	L ₁	L ₂	l	l ₁	T
L Light PN 315	DDBL-06L	6	14	17	12	27	42	14	12	27	M12 x 1.5
	DDBL-08L	8	17	19	12	29	42	17	14	27	M14 x 1.5
	DDBL-10L	10	19	22	14	30	43	18	15	28	M16 x 1.5
	DDBL-12L	12	22	24	17	32	44	20	17	29	M18 x 1.5
	DDBL-15L	15	27	30	19	36	46	23	21	31	M22 x 1.5
	DDBL-18L	18	32	36	24	40	49	24	23.5	32.5	M26 x 1.5
PN 160	DDBL-22L	22	36	41	27	44	51	30	27.5	34.5	M30 x 2
	DDBL-28L	28	41	46	36	47	52	34	30.5	35.5	M36 x 2
	DDBL-35L	35	50	55	41	56	58	39	34.5	36.5	M45 x 2
	DDBL-42L	42	60	65	50	63	59	43	40	36	M52 x 2
S Heavy PN 630	DDBL-06S	6	17	19	12	31	44	17	16	29	M14 x 1.5
	DDBL-08S	8	19	22	14	32	44	18	17	29	M16 x 1.5
	DDBL-10S	10	22	24	17	34	46	20	17.5	29.5	M18 x 1.5
	DDBL-12S	12	24	27	17	38	47	21	21.5	30.5	M20 x 1.5
	DDBL-14S	14	27	30	19	40	50	23	22	32	M22 x 1.5
PN 400	DDBL-16S	16	30	32	24	43	50	24	24.5	31.5	M24 x 1.5
	DDBL-20S	20	36	41	27	48	55	30	26.5	33.5	M30 x 2
	DDBL-25S	25	46	46	36	54	59	34	30	35	M36 x 2
	DDBL-30S	30	50	50	41	62	64	39	35.5	37.5	M42 x 2
PN 315	DDBL-38S	38	60	65	50	72	68	43	41	37	M52 x 2

Dimensions given approximate length with tightened nut. All dimensions are in millimeters, for reference only subject to change.

DDOM-U/M

Male Connector
(Unified and Metric Parallel)
with *O-Ring

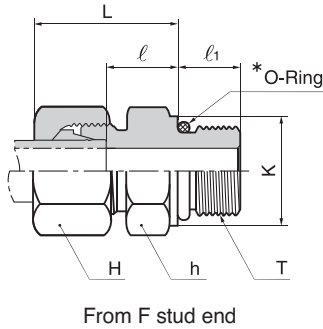

for Unified

Series	Part No.	Tube O.D.	H	h	K	L	l ₁	l	T U(Unified)
L Light PN 315	DDOM-08L-04U	8	17	17	14.4	25	9	10	7/16-20 UNF
	DDOM-10L-04U	10	19	17	14.4	26	10	11	7/16-20 UNF
	DDOM-12L-06U	12	22	19	17.6	26	10	11	9/16-18 UNF
	DDOM-12L-08U	12	22	24	22.3	28	11	13	3/4-16 UNF
	DDOM-12L-10U	12	22	27	25.5	29	12.7	14.3	7/8-14 UNF
	DDOM-15L-08U	15	27	24	22.3	29	11	14	3/4-16 UNF
	DDOM-15L-10U	15	27	27	25.5	30	12.7	15.3	7/8-14 UNF
	DDOM-18L-08U	18	32	27	22.3	31	11	14.5	3/4-16 UNF
PN 160	DDOM-18L-10U	18	32	27	25.5	31	12.7	14.8	7/8-14 UNF
	DDOM-22L-10U	22	36	32	25.5	33	12.7	16.8	7/8-14 UNF
	DDOM-22L-12U	22	36	32	31.9	33	15	16.5	1-1/16-12 UN
	DDOM-22L-16U	22	36	41	38.2	34	15	17.5	1-5/16-12 UN
	DDOM-28L-12U	28	41	41	31.9	34	15	17.5	1-1/16-12 UN
	DDOM-28L-16U	28	41	41	38.2	34	15	17.5	1-5/16-20 UN
	DDOM-35L-16U	35	50	46	38.2	39	15	17.5	1-5/16-20 UN
	DDOM-35L-20U	35	50	50	47.7	39	15	17.5	1-5/8-12 UN
S Heavy PN 630	DDOM-42L-20U	42	60	55	47.7	42	15	19	1-5/8-12 UN
	DDOM-08S-04U	8	19	17	16	30	9	15	7/16-20 UNF
	DDOM-10S-06U	10	22	19	17.6	31	10	14.5	9/16-18 UNF
	DDOM-12S-06U	12	24	22	17.6	31	10	14.5	9/16-18 UNF
PN 400	DDOM-12S-08U	12	24	24	22.3	34	11	17.5	3/4-16 UNF
	DDOM-16S-08U	16	30	24	22.3	34	11	15.5	3/4-16 UNF
	DDOM-16S-10U	16	30	27	25.5	37	12.7	18.8	7/8-14 UNF
	DDOM-20S-08U	20	36	32	22.3	42	11	20.5	3/4-16 UNF
	DDOM-20S-10U	20	36	32	25.5	42	12.7	20.8	7/8-14 UNF
	DDOM-20S-12U	20	36	32	31.9	42	15	20.5	1-1/16-12 UN
	DDOM-25S-12U	25	46	36	31.9	47	15	23	1-1/16-12 UN
	DDOM-25S-16U	25	46	41	38.2	47	15	23	1-5/16-12 UN
PN 315	DDOM-30S-16U	30	50	46	38.2	50	15	23.5	1-5/16-12 UN
	DDOM-30S-20U	30	50	50	47.7	50	15	23.5	1-5/8-12 UN

for Metric Parallel

Series	Part No.	Tube O.D.	H	h	K	L	l ₁	l	T M(Metric)
L Light PN 315	DDOM-06L-M10	6	14	14	14	23	9.5	8.5	M10 x 1
	DDOM-08L-M12	8	17	17	17	25	11	10	M12 x 1.5
	DDOM-10L-M14	10	19	19	19	26	11	11	M14 x 1.5
	DDOM-12L-M16	12	22	22	22	27	12.5	12.5	M16 x 1.5
	DDOM-15L-M18	15	27	24	24	29	14	13.5	M18 x 1.5
	DDOM-18L-M22	18	32	27	27	30	15	14.5	M22 x 1.5
PN 160	DDOM-22L-M27	22	36	32	32	33	18.5	16.5	M27 x 2
	DDOM-28L-M33	28	41	41	41	34	18.5	17.5	M33 x 2
	DDOM-35L-M42	35	50	50	50	39	19	17.5	M42 x 2
S Heavy PN 630	DDOM-06S-M12	6	17	17	17	28	11	13	M12 x 1.5
	DDOM-08S-M14	8	19	19	19	30	11	15	M14 x 1.5
	DDOM-10S-M16	10	22	22	22	31	12.5	15	M16 x 1.5
	DDOM-12S-M18	12	24	24	24	33	14	17	M18 x 1.5
PN 400	DDOM-16S-M22	16	30	27	27	37	15	18.5	M22 x 1.5
	DDOM-20S-M27	20	36	32	32	42	18.5	20.5	M27 x 2
	DDOM-25S-M33	25	46	41	41	47	18.5	23	M33 x 2
	DDOM-30S-M42	30	50	50	50	50	19	23.5	M42 x 2

Dimensions given approximate length with tightened nut. All dimensions are in millimeters, for reference only subject to change.
*O-ring of NBR Standard, of FPM(e.g Viton®) on request.

DDMC-R

Male Connector
(BSP Tapered)

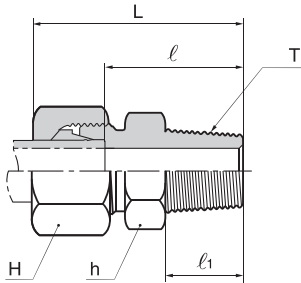

From C stud end

DDMC-G

Male Connector
(BSP Parallel)

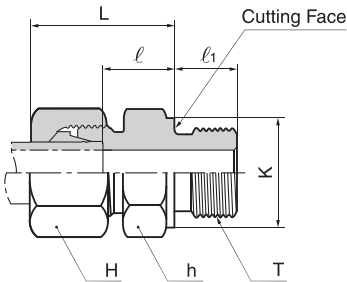

From B stud end

Series	Part No.	Tube O.D.	H	h	K	L	l	l ₁	T R(PT), G(PF)
LL Very Light PN 100	DDMC-04LL-01R	4	10	11	-	26	16	8	PT 1/8
	DDMC-06LL-01R	6	12	11	-	26	14.5	8	PT 1/8
	DDMC-08LL-01R	8	14	12	-	28	16.5	8	PT 1/8
	DDMC-08LL-02R	8	14	14	-	32	20.5	12	PT 1/4
	DDMC-10LL-02R	10	17	14	-	32	20.5	12	PT 1/4
	DDMC-12LL-02R	12	19	17	-	32	20	12	PT 1/4
	DDMC-12LL-03R	12	19	17	-	32	20	12	PT 3/8
L Light PN 315	DDMC-06L-01G	6	14	14	14	23	8.5	8	PF 1/8
	DDMC-06L-01R	6	14	12	-	30	15	8	PT 1/8
	DDMC-06L-02G	6	14	19	18	25	10	12	PF 1/4
	DDMC-06L-03G	6	14	22	22	26	11.5	12	PF 3/8
	DDMC-06L-04G	6	14	27	26	27	12	14	PF 1/2
	DDMC-08L-02G	8	17	19	18	25	10	12	PF 1/4
	DDMC-08L-01G	8	17	14	14	23	8.5	8	PF 1/8
	DDMC-08L-02R	8	17	17	-	35	20	12	PT 1/4
	DDMC-08L-03G	8	17	22	22	26	11.5	12	PF 3/8
	DDMC-08L-04G	8	17	27	26	27	12	14	PF 1/2
	DDMC-10L-02G	10	19	19	18	26	11	12	PF 1/4
	DDMC-10L-02R	10	19	17	-	36	21	12	PT 1/4
	DDMC-10L-03G	10	19	22	22	27	12.5	12	PF 3/8
	DDMC-10L-04G	10	19	27	26	28	13	14	PF 1/2
	DDMC-12L-03G	12	22	22	22	27	12.5	12	PF 3/8
	DDMC-12L-02G	12	22	19	18	27	12	12	PF 1/4
	DDMC-12L-02R	12	22	19	-	37	22	12	PT 1/4
	DDMC-12L-03R	12	22	19	-	37	22	12	PT 3/8
	DDMC-12L-04G	12	22	27	26	28	13	14	PF 1/2
	DDMC-12L-04R	12	22	24	-	39	24	14	PT 1/2
	DDMC-12L-06G	12	22	32	32	29	14	16	PF 3/4
DDMC-15L-04G	15	27	27	26	29	14	14	PF 1/2	
DDMC-15L-03G	15	27	24	22	29	13.5	12	PF 3/8	
DDMC-15L-03R	15	27	24	-	38	23	12	PT 3/8	
DDMC-15L-04R	15	27	24	-	40	25	14	PT 1/2	
DDMC-15L-06G	15	27	32	32	30	15	16	PF 3/4	
DDMC-18L-04G	18	32	27	26	31	14.5	14	PF 1/2	
DDMC-18L-03G	18	32	27	22	29.5	14	12	PF 3/8	
DDMC-18L-04R	18	32	27	-	41	25.5	14	PT 1/2	
DDMC-18L-06G	18	32	32	32	30	14.5	16	PF 3/4	

Dimensions given approximate length with tightened nut. All dimensions are in millimeters, for reference only subject to change.

DDMC-R

Male Connector
(BSP Tapered)

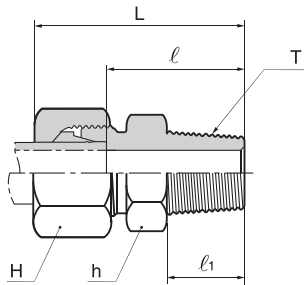

From C stud end

DDMC-G

Male Connector
(BSP Parallel)

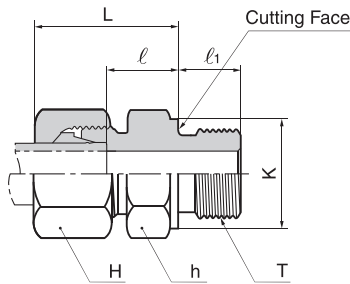

From B stud end

Series	Part No.	Tube O.D.	H	h	K	L	l	l ₁	T R(PF), G(PF)
L Light PN 160	DDMC-22L-06G	22	36	32	32	33	16.5	16	PF 3/4
	DDMC-22L-04G	22	36	32	26	33	16.5	14	PF 1/2
	DDMC-22L-06R	22	36	32	-	46	29.5	16	PT 3/4
	DDMC-28L-08G	28	41	41	39	34	17.5	18	PF 1
	DDMC-28L-06G	28	41	41	32	34	17.5	16	PF 3/4
	DDMC-35L-10G	35	50	50	49	39	17.5	20	PF 1-1/4
	DDMC-35L-08G	35	50	46	39	39	17.5	18	PF 1
	DDMC-42L-12G	42	60	55	55	42	19	22	PF 1-1/2
S Heavy PB 630	DDMC-06S-02G	6	17	19	18	28	13	12	PF 1/4
	DDMC-06S-04G	6	17	27	26	33	18	14	PF 1/2
	DDMC-08S-02G	8	19	19	18	30	15	12	PF 1/4
	DDMC-08S-03G	8	19	22	22	30	15.5	12	PF 3/8
	DDMC-10S-03G	10	22	22	22	31	15	12	PF 3/8
	DDMC-10S-02G	10	22	19	18	31	14.5	12	PF 1/4
	DDMC-10S-04G	10	22	27	26	34	17.5	14	PF 1/2
	DDMC-12S-03G	12	24	22	22	33	17	12	PF 3/8
	DDMC-12S-02G	12	24	22	18	33	16.5	12	PF 1/4
	DDMC-12S-04G	12	24	27	26	34	17.5	14	PF 1/2
	DDMC-14S-04G	14	27	27	26	37	19	14	PF 1/2
	DDMC-14S-03G	14	27	24	22	36	18.5	12	PF 3/8
PB 400	DDMC-16S-04G	16	30	27	26	37	18.5	14	PF 1/2
	DDMC-16S-03G	16	30	27	22	36	18	12	PF 3/8
	DDMC-16S-06G	16	30	32	32	39	20.5	16	PF 3/4
	DDMC-20S-06G	20	36	32	32	42	20.5	16	PF 3/4
	DDMC-20S-04G	20	36	32	26	42	20.5	14	PF 1/2
	DDMC-25S-08G	25	46	41	39	47	23	18	PF 1
PB 250	DDMC-25S-06G	25	46	41	32	47	23	16	PF 3/4
	DDMC-30S-10G	30	50	50	49	50	23.5	20	PF 11/4
	DDMC-30S-08G	30	50	46	39	50	23.5	18	PF 1
	DDMC-38S-12G	38	60	55	55	57	26	22	PF 1-1/2
DDMC-38S-10G	38	60	55	49	57	26	20	PF 1-1/4	

Dimensions given approximate length with tightened nut. All dimensions are in millimeters, for reference only subject to change.

DDMC-MK

Male Connector
(Metric Tapered)

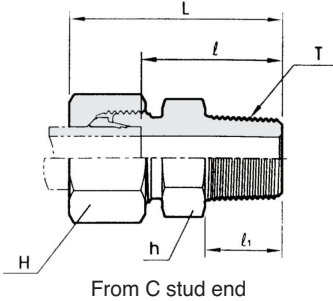

DDMC-M

Male Connector
(Metric Parallel)

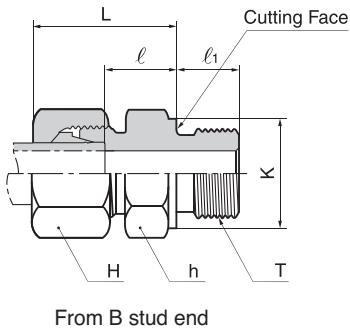

Series	Part No.	Tube O.D.	H	h	K	L	ℓ	ℓ ₁	T M(Metric)
LL Very Light PN 100	DDMC-04LL-M06K	4	10	9	-	26	16	8	M6 x 1keg
	DDMC-04LL-M08K	4	10	10	-	26	16	8	M8 x 1keg
	DDMC-06LL-M10K	6	12	11	-	26	14.5	8	M10 x 1keg
	DDMC-08LL-M10K	8	14	12	-	28	16.5	8	M10 x 1keg
L Light PN 315	DDMC-06L-M10	6	14	14	14	23	8.5	8	M10 x 1
	DDMC-08L-M12	8	17	17	17	25	10	12	M12 x 1.5
	DDMC-08L-M18	8	17	24	23	26	11.5	12	M18 x 1.5
	DDMC-10L-M14	10	19	19	19	26	11	12	M14 x 1.5
	DDMC-10L-M16	10	19	22	21	27	12	12	M16 x 1.5
	DDMC-10L-M18	10	19	24	23	27	12.5	12	M18 x 1.5
	DDMC-10L-M22	10	19	27	27	29	14	14	M22 x 1.5
	DDMC-12L-M14	12	22	19	19	26	11	12	M14 x 1.5
	DDMC-12L-M16	12	22	22	21	27	12.5	12	M16 x 1.5
	DDMC-12L-M18	12	22	24	23	27	12.5	12	M18 x 1.5
	DDMC-12L-M22	12	22	27	27	29	14	14	M22 x 1.5
	DDMC-15L-M16	15	27	24	21	28	13	12	M16 x 1.5
	DDMC-15L-M18	15	27	24	23	29	13.5	12	M18 x 1.5
	DDMC-15L-M22	15	27	27	27	30	15	14	M22 x 1.5
PN 160	DDMC-18L-M18	18	32	27	23	30	14	12	M18 x 1.5
	DDMC-18L-M22	18	32	27	27	31	14.5	14	M22 x 1.5
	DDMC-22L-M22	22	36	32	27	33	16.5	14	M22 x 1.5
	DDMC-22L-M26	22	36	32	31	33	16.5	16	M26 x 1.5
	DDMC-28L-M23	28	41	41	39	34	17.5	18	M33 x 2
S Heavy PB 630	DDMC-35L-M42	35	50	50	49	39	17.5	20	M42 x 2
	DDMC-42L-M48	42	60	55	55	42	19	22	M48 x 2
	DDMC-06S-M12	6	17	17	17	28	13	12	M12 x 1.5
	DDMC-08S-M14	8	19	19	19	30	15	12	M14 x 1.5
	DDMC-10S-M16	10	22	22	21	31	15	12	M16 x 1.5
	DDMC-12S-M18	12	24	24	23	33	17	12	M18 x 1.5
PB 400	DDMC-12S-M22	12	24	27	27	34	17.5	14	M22 x 1.5
	DDMC-14S-M20	14	27	27	25	37	19	14	M20 x 1.5
	DDMC-16S-M18	16	30	27	23	36	18	12	M18 x 1.5
	DDMC-16S-M22	16	30	27	27	37	18.5	14	M22 x 1.5
PB 250	DDMC-20S-M27	20	36	32	32	42	20.5	16	M27 x 2
	DDMC-25S-M33	25	46	41	39	47	23	18	M33 x 2
	DDMC-30S-M42	30	50	50	49	50	23.5	20	M42 x 2
	DDMC-38S-M48	38	60	55	55	57	26	22	M48 x 2

Dimensions given approximate length with tightened nut. All dimensions are in millimeters, for reference only subject to change.

DDMC-GED

Male Connector
(BSP Parallel) with *ED-Ring

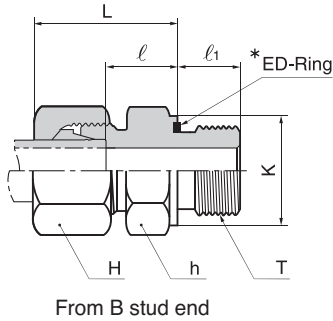

Series	Part No.	Tube O.D.	H	h	K	L	l	l ₁	T G(PF)
L Light PN 315	DDMC-06L-01GED	6	14	14	14	23	8.5	8	1/8
	DDMC-06L-02GED	6	14	19	19	25	10	12	1/4
	DDMC-08L-01GED	8	17	14	14	24	9.5	8	1/8
	DDMC-08L-02GED	8	17	19	19	25	10	12	1/4
	DDMC-08L-03GED	8	17	22	22	26	11.5	12	3/8
	DDMC-10L-02GED	10	19	19	19	26	11	12	1/4
	DDMC-10L-03GED	10	19	22	22	27	12.5	12	3/8
	DDMC-10L-04GED	10	19	27	27	28	13	14	1/2
	DDMC-12L-02GED	12	22	19	19	27	12	12	1/4
	DDMC-12L-03GED	12	22	22	22	27	12.5	12	3/8
	DDMC-12L-04GED	12	22	27	27	28	13	14	1/2
	DDMC-15L-03GED	15	27	24	22	29	13.5	12	3/8
	DDMC-15L-04GED	15	27	27	27	29	14	14	1/2
	DDMC-18L-04GED	18	32	27	27	31	14.5	14	1/2
	DDMC-18L-06GED	18	32	32	32	31	14.5	16	3/4
PN 160	DDMC-22L-06GED	22	36	32	32	33	16.5	16	3/4
	DDMC-28L-08GED	28	41	41	40	34	17.5	18	1
	DDMC-35L-10GED	35	50	50	50	39	17.5	20	1-1/4
	DDMC-42L-12GED	42	60	55	55	42	19	22	1-1/2
S Heavy PN 630	DDMC-06S-02GED	6	17	19	19	28	13	12	1/4
	DDMC-08S-02GED	8	19	19	19	30	15	12	1/4
	DDMC-08S-03GED	8	19	22	22	30	15.5	12	3/8
	DDMC-10S-02GED	10	22	19	19	31	14.5	12	1/4
	DDMC-10S-03GED	10	22	22	22	31	15	12	3/8
	DDMC-10S-04GED	10	22	27	27	34	17.5	14	1/2
	DDMC-12S-02GED	12	24	22	19	33	16.5	12	1/4
	DDMC-12S-03GED	12	24	22	22	33	17	12	3/8
	DDMC-12S-04GED	12	24	27	32	34	17.5	14	1/2
DDMC-14S-04GED	14	27	27	27	37	19	14	1/2	
PN 400	DDMC-16S-03GED	16	30	27	22	36	18	12	3/8
	DDMC-16S-04GED	16	30	27	27	37	18.5	14	1/2
	DDMC-16S-06GED	16	30	32	27	39	20.5	16	3/4
	DDMC-20S-06GED	20	36	32	32	42	20.5	16	3/4
	DDMC-25S-04GED	25	46	41	27	47	23	14	1/2
	DDMC-25S-06GED	25	46	41	32	47	23	16	3/4
	DDMC-25S-08GED	25	46	41	40	47	23	18	1
DDMC-30S-10GED	30	50	50	50	50	23.5	20	1-1/4	
PN 315	DDMC-38S-12GED	38	60	55	55	57	26	22	1-1/2

Dimensions given approximate length with tightened nut. All dimensions are in millimeters, for reference only subject to change.
*ED-ring of NBR Standard, of FPM(e.g Viton) on request.

DDMC-MED

Male Connector
with *ED-Ring

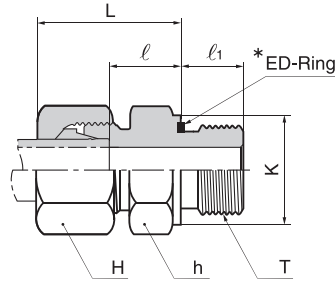

From B stud end

Series	Part No.	Tube O.D.	H	h	K	L	l	l ₁	T M(Metric)
L Light PN 315	DDMC-06L-M10ED	6	14	14	14	23	8.5	8	M10 x 1
	DDMC-08L-M12ED	8	17	17	17	25	10	12	M12 x 1.5
	DDMC-10L-M14ED	10	19	19	19	26	11	12	M14 x 1.5
	DDMC-12L-M16ED	12	22	22	22	27	12.5	12	M16 x 1.5
	DDMC-12L-M18ED	12	22	24	24	27	12.5	12	M18 x 1.5
	DDMC-12L-M22ED	12	22	27	27	29	14	14	M22 x 1.5
	DDMC-15L-M18ED	15	27	24	24	29	13.5	12	M18 x 1.5
	DDMC-15L-M22ED	15	27	27	27	30	15	14	M22 x 1.5
PN 160	DDMC-18L-M22ED	18	32	27	27	31	14.5	14	M22 x 1.5
	DDMC-22L-M26ED	22	36	32	32	33	16.5	16	M26 x 1.5
	DDMC-28L-M33ED	28	41	41	40	34	17.5	18	M33 x 2
	DDMC-35L-M42ED	35	50	50	50	39	17.5	20	M42 x 2
S Heavy PN 630	DDMC-42L-M48ED	42	60	55	55	42	19	22	M48 x 2
	DDMC-06S-M12ED	6	17	17	17	28	13	12	M12 x 1.5
	DDMC-08S-M14ED	8	19	19	19	30	15	12	M14 x 1.5
	DDMC-10S-M16ED	10	22	22	22	31	15	12	M16 x 1.5
	DDMC-12S-M18ED	12	24	24	24	33	17	12	M18 x 1.5
PN 400	DDMC-14S-M20ED	14	27	27	26	37	19	14	M20 x 1.5
	DDMC-16S-M22ED	16	30	27	27	37	18.5	14	M22 x 1.5
	DDMC-20S-M27ED	20	36	32	32	42	20.5	16	M27 x 2
	DDMC-25S-M33ED	25	46	41	40	47	23	18	M33 x 2
PN 315	DDMC-30S-M42ED	30	50	50	50	50	23.5	20	M42 x 2
	DDMC-38S-M48ED	38	60	55	55	57	26	22	M48 x 2

Dimensions given approximate length with tightened nut. All dimensions are in millimeters, for reference only subject to change.
*ED-ring of NBR Standard, of FPM(e.g Viton®) on request.

DDMC-N

Male Connector
(NPT Thread)

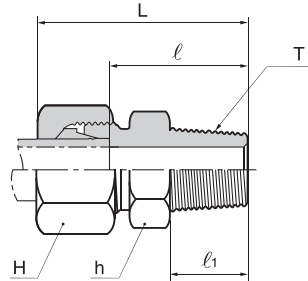

From C stud end

Series	Part No.	Tube O.D.	H	h	L	l	l ₁	T N(NPT)
LL Very Light PN 100	DDMC-04LL-01N	4	10	11	28	18.5	9.9	1/8
	DDMC-06LL-01N	6	12	11	28	16.5	9.9	1/8
	DDMC-08LL-01N	8	14	12	30	18.5	9.9	1/8
L Light PN 315	DDMC-06L-01N	6	14	12	32	17	9.9	1/8
	DDMC-06L-02N	6	14	17	38	23	14.2	1/4
	DDMC-08L-02N	8	17	17	38	23	14.2	1/4
	DDMC-10L-02N	10	19	17	39	24	14.2	1/4
	DDMC-10L-03N	10	19	19	40	25	14.2	3/8
	DDMC-12L-02N	12	22	19	40	25	14.2	1/4
	DDMC-12L-03N	12	22	19	40	25	14.2	3/8
	DDMC-12L-04N	12	22	22	45	30	19.1	1/2
	DDMC-15L-04N	15	27	24	46	31	19.1	1/2
	DDMC-18L-04N	18	32	27	48	31.5	19.1	1/2
PN 160	DDMC-22L-06N	22	36	32	50	33.5	19.1	3/4
	DDMC-28L-08N	28	41	41	56	39.5	23.9	1
	DDMC-35L-10N	35	50	46	62	40.5	23.9	1 1/4
	DDMC-42L-12N	42	60	55	65	42	25.4	1 1/2
S Heavy PN 630	DDMC-06S-02N	6	17	17	43	28	14.2	1/4
	DDMC-08S-02N	8	19	17	43	28	14.2	1/4
	DDMC-10S-02N	10	22	19	44	27.5	14.2	1/4
	DDMC-10S-03N	10	22	19	44	27.5	14.2	3/8
	DDMC-12S-02N	12	24	22	46	29.5	14.2	1/4
	DDMC-12S-03N	12	24	22	46	29.5	14.2	3/8
	DDMC-12S-04N	12	24	22	51	34.5	19.1	1/2
	DDMC-14S-04N	14	27	24	54	36	19.1	1/2
PN 400	DDMC-16S-04N	16	30	27	54	35.5	19.1	1/2
	DDMC-20S-06N	20	36	32	59	37.5	19.1	3/4
	DDMC-25S-08N	25	46	41	69	45	23.9	1
	DDMC-30S-10N	30	50	46	73	46.5	23.9	1-1/4
PN 315	DDMC-38S-12N	38	60	55	80	49	25.4	1-1/2

Dimensions given approximate length with tightened nut. All dimensions are in millimeters, for reference only subject to change.

DDLM-R/M

Male Elbow
(BSP Tapered/Metric Tapered)

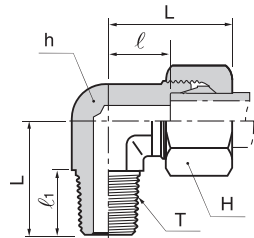

From C stud end

Series	Part No.	Tube O.D.	H	h	L	L ₁	l	T Metric Taper	l ₁	T R(PT)	l ₁	
LL Very Light PN 100	DDLM-04LL-01R	SDLM-04LL-M 8K	4	10	9	21	17	11	M8 x 1 keg	8	1/8	10
	DDLM-06LL-01R	SDLM-06LL-M10K	6	12	9	21	17	9.5	M10 x 1 keg	8	1/8	10
	DDLM-08LL-01R	SDLM-08LL-M10K	8	14	12	23	20	11.5	M10 x 1 keg	8	1/8	10
	DDLM-10LL-02R	-	10	17	14	24	23	12.5	-	-	1/4	14
	DDLM-12LL-02R	-	12	19	17	25	23	13	-	-	1/4	14
L Light PN 315	DDLM-06L-01R	SDLM-06L-M10K	6	14	12	27	20	12	M10 x 1 keg	8	1/8	10
	DDLM-08L-02R	SDLM-08L-M12K	8	17	12	29	26	14	M12 x 1.5keg	12	1/4	14
	DDLM-10L-02R	SDLM-10L-M14K	10	19	14	30	27	15	M14 x 1.5keg	12	1/4	14
	DDLM-12L-03R	SDLM-12L-M16K	12	22	17	32	28	17	M16 x 1.5keg	14	3/8	15
	DDLM-15L-04R	SDLM-15L-M18K	15	27	19	36	34	21	M18 x 1.5keg	14	1/2	19
	DDLM-18L-04R	SDLM-18L-M22K	18	32	24	40	36	23.5	M22 x 1.5keg	17	1/2	19
S Heavy PN 400	DDLM-06S-02R	SDLM-06S-M12K	6	17	12	31	26	16	M12 x 1.5keg	12	1/4	14
	DDLM-08S-02R	SDLM-08S-M14K	8	19	14	32	27	17	M14 x 1.5keg	12	1/4	14
	DDLM-10S-03R	SDLM-10S-M16K	10	22	17	34	28	17.5	M16 x 1.5keg	12	3/8	15
	DDLM-12S-03R	SDLM-12S-M18K	12	24	17	38	28	21.5	M18 x 1.5keg	12	3/8	15
	DDLM-14S-04R	SDLM-14S-M20K	14	27	19	40	32	22	M20 x 1.5keg	14	1/2	19
	DDLM-16S-04R	SDLM-16S-M22K	16	30	24	43	32	24.5	M22 x 1.5keg	17	1/2	19

Dimensions given approximate length with tightened nut. All dimensions are in millimeters, for reference only subject to change.

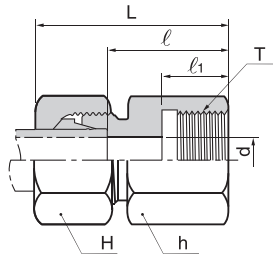
DDFC-G/MFemale Connector
(BSP Parallel/Metric Parallel)

From Y Tapped Hole

for BSP Parallel

Series	Part No.	Tube O.D.	d	H	h	L	ℓ	ℓ ₁	T G(PF)
L Light PB 315	DDFC-06L-01G	6	4	14	14	34	19	12	1/8
	DDFC-08L-02G	8	6	17	19	39	24	17	1/4
	DDFC-08L-03G	8	6	17	24	40	25	17	3/8
	DDFC-08L-04G	8	6	17	27	44	29	20	1/2
	DDFC-10L-02G	10	8	19	19	40	25	17	1/4
	DDFC-10L-03G	10	8	19	24	41	26	17	3/8
	DDFC-10L-04G	10	8	19	27	45	30	20	1/2
	DDFC-12L-03G	12	10	22	24	41	26	17	3/8
	DDFC-12L-04G	12	10	22	27	45	30	20	1/2
	DDFC-15L-04G	15	12	27	27	46	31	20	1/2
	DDFC-18L-04G	18	15	32	27	47	30.5	20	1/2
PB 160	DDFC-22L-06G	22	19	36	36	52	35.5	22	3/4
	DDFC-28L-08G	28	24	41	41	55	38	24.5	1
	DDFC-35L-10G	35	30	50	55	63	41	26.5	1-1/4
	DDFC-42L-12G	42	36	60	60	65	42.5	28.5	1-1/2
S Heavy PB 630	DDFC-06S-02G	6	4	17	19	41	26	17	1/4
	DDFC-08S-02G	8	5	19	19	41	26	17	1/4
	DDFC-10S-03G	10	7	22	24	43	26.5	17	3/8
	DDFC-12S-03G	12	8	24	24	43	26.5	17	3/8
	DDFC-14S-04G	14	10	27	30	50	32	20	1/2
PB 400	DDFC-16S-04G	16	12	30	30	50	31.5	20	1/2
	DDFC-20S-06G	20	16	36	36	56	34.5	22	3/4
	DDFC-25S-08G	25	20	46	41	62	37.5	24.5	1
	DDFC-30S-10G	30	25	50	55	69	42	26.5	1-1/4
PB 315	DDFC-38S-12G	38	32	60	60	74	43.5	28.5	1-1/2

for Metric Parallel

Series	Part No.	Tube O.D.	d	H	h	L	ℓ	ℓ ₁	T M(Metric)
L Light PB 315	DDFC-06L-M10	6	4	14	14	34	19.5	12.5	M10 x 1
	DDFC-08L-M12	8	6	17	17	39	24	17	M12 x 1.5
	DDFC-10L-M14	10	8	19	19	40	25	17	M14 x 1.5
	DDFC-12L-M16	12	10	22	22	41	26	17	M16 x 1.5
	DDFC-15L-M18	15	12	27	24	43	28	17	M18 x 1.5
	DDFC-18L-M22	18	15	32	30	46	29.5	19	M22 x 1.5
PB 160	DDFC-22L-M26	22	19	36	32	51	34.5	21	M26 x 1.5
	DDFC-28L-M33	28	24	41	41	54	37.5	24	M33 x 2
	DDFC-35L-M42	35	30	50	55	62	40.5	26	M42 x 2
	DDFC-42L-M48	42	36	60	60	65	42	28	M48 x 2
S Heavy PB 630	DDFC-06S-M12	6	4	17	17	41	26	17	M12 x 1.5
	DDFC-08S-M14	8	5	19	17	41	26	17	M14 x 1.5
	DDFC-10S-M16	10	7	22	22	43	26.5	17	M16 x 1.5
	DDFC-12S-M18	12	8	24	24	44	27.5	17	M18 x 1.5
	DDFC-14S-M20	14	10	27	27	49	31	19	M20 x 1.5
PB 400	DDFC-16S-M22	16	12	30	30	49	30.5	19	M22 x 1.5
	DDFC-20S-M27	20	16	36	36	56	34.5	22	M27 x 2
	DDFC-25S-M33	25	20	46	41	61	37	24	M33 x 2
	DDFC-30S-M42	30	25	50	55	68	41.5	26	M42 x 2
PB 315	DDFC-38S-M48	38	32	60	60	74	43	28	M48 x 2

Dimensions given approximate length with tightened nut. All dimensions are in millimeters, for reference only subject to change.

DDLA

Adjustable Elbow with Standpipe

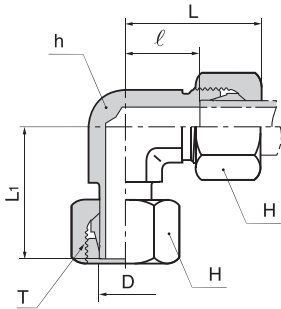

Series	Part No.	Tube O.D.	D	H	h	L	L ₁	ℓ	T
L Light PN 315	DDLA-06L	6	6	14	12	27	26	12	M12 x 1.5
	DDLA-08L	8	8	17	12	29	27.5	14	M14 x 1.5
	DDLA-10L	10	10	19	14	30	29	15	M16 x 1.5
	DDLA-12L	12	12	22	17	32	29.5	17	M18 x 1.5
	DDLA-15L	15	15	27	19	36	32.5	21	M22 x 1.5
	DDLA-18L	18	18	32	24	40	35.5	23.5	M26 x 1.5
PN 160	DDLA-22L	22	22	36	27	44	38.5	27.5	M30 x 2
	DDLA-28L	28	28	41	36	47	41.5	30.5	M36 x 2
	DDLA-35L	35	35	50	41	56	51	34.5	M45 x 2
	DDLA-42L	42	42	60	50	63	56	40	M52 x 2
S Heavy PN 630	DDLA-06S	6	6	17	12	31	27	16	M14 x 1.5
	DDLA-08S	8	8	19	14	32	27.5	17	M16 x 1.5
	DDLA-10S	10	10	22	17	34	30	17.5	M18 x 1.5
	DDLA-12S	12	12	24	17	38	31	21.5	M20 x 1.5
	DDLA-14S	14	14	27	19	40	35	22	M22 x 1.5
PN 400	DDLA-16S	16	16	30	24	43	36.5	24.5	M24 x 1.5
	DDLA-20S	20	20	36	27	48	44.5	26.5	M30 x 2
	DDLA-25S	25	25	46	36	54	50	30	M36 x 2
	DDLA-30S	30	30	50	41	62	55	35.5	M42 x 2
PN 315	DDLA-38S	38	38	60	50	72	63	41	M52 x 2

Dimensions given approximate length with tightened nut. All dimensions are in millimeters, for reference only subject to change. Without male stud, but with pre-settled nut and cutting ring for connection.

DDBTA

Adjustable Branch Tee with Standpipe

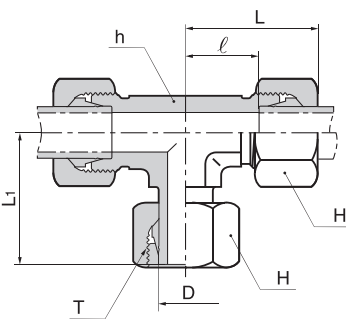

Series	Part No.	Tube O.D.	D	H	h	L	L ₁	ℓ	T
L Light PN 315	DDBTA-06L	6	6	14	12	27	26	12	M12 x 1.5
	DDBTA-08L	8	8	17	12	29	27.5	14	M14 x 1.5
	DDBTA-10L	10	10	19	14	30	29	15	M16 x 1.5
	DDBTA-12L	12	12	22	17	32	29.5	17	M18 x 1.5
	DDBTA-15L	15	15	27	19	36	32.5	21	M22 x 1.5
	DDBTA-18L	18	18	32	24	40	35.5	23.5	M26 x 1.5
PN 160	DDBTA-22L	22	22	36	27	44	38.5	27.5	M30 x 2
	DDBTA-28L	28	28	41	36	47	41.5	30.5	M36 x 2
	DDBTA-35L	35	35	50	41	56	51	34.5	M45 x 2
	DDBTA-42L	42	42	60	50	63	56	40	M52 x 2
S Heavy PN 630	DDBTA-06S	6	6	17	12	31	27	16	M14 x 1.5
	DDBTA-08S	8	8	19	14	32	27.5	17	M16 x 1.5
	DDBTA-10S	10	10	22	17	34	30	17.5	M18 x 1.5
	DDBTA-12S	12	12	24	17	38	31	21.5	M20 x 1.5
	DDBTA-14S	14	14	27	19	40	35	22	M22 x 1.5
PN 400	DDBTA-16S	16	16	30	24	43	36.5	24.5	M24 x 1.5
	DDBTA-20S	20	20	36	27	48	44.5	26.5	M30 x 2
	DDBTA-25S	25	25	46	36	54	50	30	M36 x 2
	DDBTA-30S	30	30	50	41	62	55	35.5	M42 x 2
PN 315	DDBTA-38S	38	38	60	50	72	63	41	M52 x 2

Dimensions given approximate length with tightened nut. All dimensions are in millimeters, for reference only subject to change. Without male stud, but with pre-settled nut and cutting ring for connection.

DDRTA

Adjustable Run Tee with Standpipe

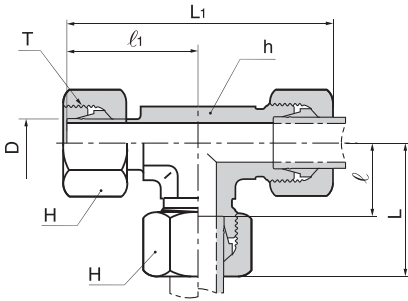

Series	Part No.	Tube O.D.	D	h	H	L	L ₁	ℓ	ℓ ₁	T
L Light PN 315	DDRTA-06L	6	6	12	14	27	53	12	26	M12 x 1.5
	DDRTA-08L	8	8	12	17	29	56	14	27.5	M14 x 1.5
	DDRTA-10L	10	10	14	19	30	59	15	29	M16 x 1.5
	DDRTA-12L	12	12	17	22	32	62	17	29.5	M18 x 1.5
	DDRTA-15L	15	15	19	27	36	69	21	32.5	M22 x 1.5
	DDRTA-18L	18	18	24	32	40	75	23.5	35.5	M26 x 1.5
PN 160	DDRTA-22L	22	22	27	36	44	83	27.5	38.5	M30 x 2
	DDRTA-28L	28	28	36	41	47	91	30.5	41.5	M36 x 2
	DDRTA-35L	35	35	41	50	56	111	34.5	51	M45 x 2
	DDRTA-42L	42	42	50	60	63	123	40	56	M52 x 2
S Heavy PN 630	DDRTA-06S	6	6	12	17	31	58	16	27	M14 x 1.5
	DDRTA-08S	8	8	14	19	32	61	17	27.5	M16 x 1.5
	DDRTA-10S	10	10	17	22	34	66	17.5	30	M18 x 1.5
	DDRTA-12S	12	12	17	24	38	71	21.5	31	M20 x 1.5
	DDRTA-14S	14	14	19	27	40	75	22	35	M22 x 1.5
PN 400	DDRTA-16S	16	16	24	30	43	79	24.5	36.5	M24 x 1.5
	DDRTA-20S	20	20	27	36	48	93	26.5	44.5	M30 x 2
	DDRTA-25S	25	25	36	46	54	105	30	50	M36 x 2
	DDRTA-30S	30	30	41	50	62	119	35.5	55	M42 x 2
PN 315	DDRTA-38S	38	38	50	60	72	138	41	63	M52 x 2

Dimensions given approximate length with tightened nut. All dimensions are in millimeters, for reference only subject to change. Without male stud, but with pre-settled nut and cutting ring for connection.

DDEW

Swivel Adjustable Elbow with Cone

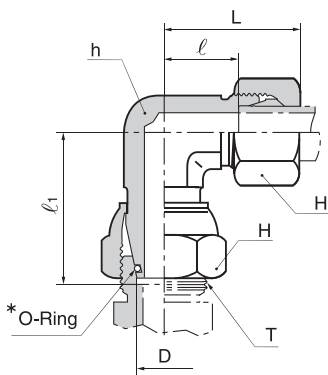

Series	Part No.	Tube O.D.	D	H	h	L	ℓ	ℓ ₁	T
L Light PN 315	DDEW-06L	6	6	14	12	27	12	26	M12 x 1.5
	DDEW-08L	8	8	17	12	29	14	27.5	M14 x 1.5
	DDEW-10L	10	10	19	14	30	15	29	M16 x 1.5
	DDEW-12L	12	12	22	17	32	17	29.5	M18 x 1.5
	DDEW-15L	15	15	27	19	36	21	32.5	M22 x 1.5
	DDEW-18L	18	18	32	24	40	23.5	35.5	M26 x 1.5
PN 160	DDEW-22L	22	22	36	27	44	27.5	38.5	M30 x 2
	DDEW-28L	28	28	41	36	47	30.5	41.5	M36 x 2
	DDEW-35L	35	35	50	41	56	34.5	51	M45 x 2
	DDEW-42L	42	42	60	50	63	40	56	M52 x 2
S Heavy PN 630	DDEW-06S	6	6	17	12	31	16	27	M14 x 1.5
	DDEW-08S	8	8	19	14	32	17	27.5	M16 x 1.5
	DDEW-10S	10	10	22	17	34	17.5	30	M18 x 1.5
	DDEW-12S	12	12	24	17	38	21.5	31	M20 x 1.5
	DDEW-14S	14	14	27	19	40	22	35	M22 x 1.5
PN 400	DDEW-16S	16	16	30	24	43	24.5	36.5	M24 x 1.5
	DDEW-20S	20	20	36	27	48	26.5	44.5	M30 x 2
	DDEW-25S	25	25	36	36	54	30	50	M36 x 2
	DDEW-30S	30	30	50	41	62	35.5	55	M42 x 2
PN 315	DDEW-38S	38	38	60	50	72	41	63	M52 x 2

Dimensions given approximate length with tightened nut. All dimensions are in millimeters, for reference only subject to change. Without male stud, but supplied with fitted O-Ring for connection.

*O-ring of NBR Standard, of FPM(e.g Viton®) on request.

DDET

Swivel Adjustable Branch Tee with Cone

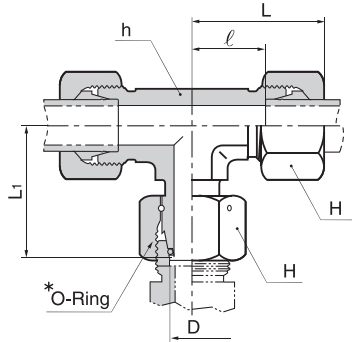

Series	Part No.	Tube O.D. D	H	h	L	L ₁	ℓ	T
L Light PN 315	DDET-06L	6	14	12	27	26	12	M12 x 1.5
	DDET-08L	8	17	12	29	27.5	14	M14 x 1.5
	DDET-10L	10	19	14	30	29	15	M16 x 1.5
	DDET-12L	12	22	17	32	29.5	17	M18 x 1.5
	DDET-15L	15	27	19	36	32.5	21	M22 x 1.5
	DDET-18L	18	32	24	40	35.5	23.5	M26 x 1.5
PN 160	DDET-22L	22	36	27	44	38.5	27.5	M30 x 2
	DDET-28L	28	41	36	47	41.5	30.5	M36 x 2
	DDET-35L	35	50	41	56	51	34.5	M45 x 2
	DDET-42L	42	60	50	63	56	40	M52 x 2
S Heavy PN 630	DDET-06S	6	17	12	31	27	16	M14 x 1.5
	DDET-08S	8	19	14	32	27.5	17	M16 x 1.5
	DDET-10S	10	22	17	34	30	17.5	M18 x 1.5
	DDET-12S	12	24	17	38	31	21.5	M20 x 1.5
	DDET-14S	14	27	19	40	35	22	M22 x 1.5
PN 400	DDET-16S	16	30	24	43	36.5	24.5	M24 x 1.5
	DDET-20S	20	36	27	48	44.5	26.5	M30 x 2
	DDET-25S	25	46	36	54	50	30	M36 x 2
	DDET-30S	30	50	41	62	55	35.5	M42 x 2
PN 315	DDET-38S	38	60	50	72	63	41	M52 x 2

Dimensions given approximate length with tightened nut. All dimensions are in millimeters, for reference only subject to change. Without male stud, but supplied with fitted O-Ring for connection. *O-ring of NBR Standard, of FPM(e.g Viton®) on request.

DDEL

Swivel Adjustable Run Tee with Cone

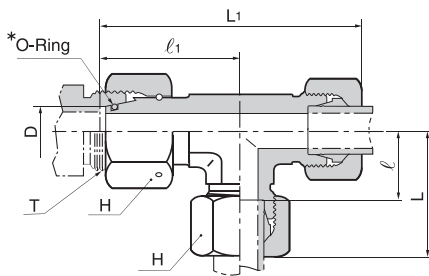

Series	Part No.	Tube O.D. D	H	h	L	L ₁	ℓ	ℓ ₁	T
L Light PN 315	DDEL-06L	6	14	12	27	53	12	26	M12 x 1.5
	DDEL-08L	8	17	12	29	56	14	27.5	M14 x 1.5
	DDEL-10L	10	19	14	30	59	15	29	M16 x 1.5
	DDEL-12L	12	22	17	32	61	17	29.5	M18 x 1.5
	DDEL-15L	15	27	19	36	69	21	32.5	M22 x 1.5
	DDEL-18L	18	32	24	40	75	23.5	35.5	M26 x 1.5
PN 160	DDEL-22L	22	36	27	44	82	27.5	38.5	M30 x 2
	DDEL-28L	28	41	36	47	89	30.5	41.5	M36 x 2
	DDEL-35L	35	50	41	56	107	34.5	51	M45 x 2
	DDEL-42L	42	60	50	63	119	40	56	M52 x 2
S Heavy PN 630	DDEL-06S	6	17	12	31	58	16	27	M14 x 1.5
	DDEL-08S	8	19	14	32	59	17	27.5	M16 x 1.5
	DDEL-10S	10	22	17	34	64	17.5	30	M18 x 1.5
	DDEL-12S	12	24	17	38	69	21.5	31	M20 x 1.5
	DDEL-14S	14	27	19	40	75	22	35	M22 x 1.5
PN 400	DDEL-16S	16	30	24	43	79	24.5	36.5	M24 x 1.5
	DDEL-20S	20	36	27	48	93	26.5	44.5	M30 x 2
	DDEL-25S	25	46	36	54	104	30	50	M36 x 2
	DDEL-30S	30	50	41	62	117	35.5	55	M42 x 2
PN 315	DDEL-38S	38	60	50	72	135	41	63	M52 x 2

Dimensions given approximate length with tightened nut. All dimensions are in millimeters, for reference only subject to change. Without male stud, but supplied with fitted O-Ring for connection. *O-ring of NBR Standard, of FPM(e.g Viton®) on request.

DDKOR

Standpipe Reducer

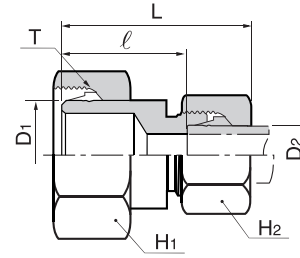

Series L (Light)

Series	Part No.	Tube O.D. D ₁ D ₂	H ₁	H ₂	L	l	T
PN 315	DDKOR-08L-06L	8 6	17	14	38	23.5	M14 x 1.5
PN 315	DDKOR-10L-06L	10 6	19	14	38	23.5	M16 x 1.5
	DDKOR-10L-08L	8	17				
PN 315	DDKOR-12L-06L	12 6	22	14	38	23.5	M18 x 1.5
	DDKOR-12L-08L	8	17	38	23.5		
	DDKOR-12L-10L	10	19	39	24.5		
PN 315	DDKOR-15L-06L	15 6	27	14	38	23.5	M22 x 1.5
	DDKOR-15L-08L	8	17	38	23.5		
	DDKOR-15L-10L	10	19	39	24.5		
	DDKOR-15L-12L	12	22	39	24.5		
PN 315	DDKOR-18L-06L	18 6	32	14	39	24.5	M26 x 1.5
	DDKOR-18L-08L	8	17	39	24.5		
	DDKOR-18L-10L	10	19	40	25.5		
	DDKOR-18L-12L	12	22	40	25.5		
	DDKOR-18L-15L	15	27	42	26.5		
PN 160	DDKOR-22L-06L	22 6	36	14	40	25.5	M30 x 2
	DDKOR-22L-08L	8	17	40	25.5		
	DDKOR-22L-10L	10	19	41	26.5		
	DDKOR-22L-12L	12	22	41	26.5		
	DDKOR-22L-15L	15	27	43	27.5		
	DDKOR-22L-18L	18	32	43	27		
PN 160	DDKOR-28L-06L	28 6	41	14	41	26.5	M36 x 2
	DDKOR-28L-08L	8	17	41	26.5		
	DDKOR-28L-10L	10	19	42	27.5		
	DDKOR-28L-12L	12	22	42	27.5		
	DDKOR-28L-15L	15	27	44	28.5		
	DDKOR-28L-18L	18	32	44	28		
PN 160	DDKOR-35L-06L	35 6	50	14	46	31.5	M45 x 2
	DDKOR-35L-08L	8	17	46	31.5		
	DDKOR-35L-10L	10	19	47	32.5		
	DDKOR-35L-12L	12	22	47	32.5		
	DDKOR-35L-15L	15	27	49	33.5		
	DDKOR-35L-18L	18	32	49	33		
	DDKOR-35L-22L	22	36	51	35		
PN 160	DDKOR-42L-10L	42 10	60	19	48	33.5	M52 x 2
	DDKOR-42L-12L	12	22	48	33.5		
	DDKOR-42L-15L	15	27	50	34.5		
	DDKOR-42L-18L	18	32	50	34		
	DDKOR-42L-22L	22	36	52	36		
	DDKOR-42L-28L	28	41	53	36		
	DDKOR-42L-35L	35	50	57	35		

Series S (Heavy)

Series	Part No.	Tube O.D. D ₁ D ₂	H ₁	H ₂	L	l	T
PN 630	DDKOR-08S-06S	8 6	19	17	40	25	M16 x 1.5
PN 630	DDKOR-10S-06S	10 6	22	17	41	26	M18 x 1.5
	DDKOR-10S-08S	8	19	41	26		
PN 630	DDKOR-12S-06S	12 6	24	17	42	27	M20 x 1.5
	DDKOR-12S-08S	8	19	42	27		
	DDKOR-12S-10S	10	22	43	26.5		
PN 630	DDKOR-14S-06S	14 6	27	17	44	29	M22 x 1.5
	DDKOR-14S-08S	8	19	44	29		
	DDKOR-14S-10S	10	22	45	28.5		
	DDKOR-14S-12S	12	24	45	28.5		
PN 400	DDKOR-16S-06S	16 6	30	17	44	29	M24 x 1.5
	DDKOR-16S-08S	8	19	44	29		
	DDKOR-16S-10S	10	22	45	28.5		
	DDKOR-16S-12S	12	24	45	28.5		
	DDKOR-16S-14S	14	27	48	30		
PN 400	DDKOR-20S-06S	20 6	36	17	49	34	M30 x 2
	DDKOR-20S-08S	8	19	49	34		
	DDKOR-20S-10S	10	22	50	33.5		
	DDKOR-20S-12S	12	24	50	33.5		
	DDKOR-20S-14S	14	27	53	35		
	DDKOR-20S-16S	16	30	53	34.5		
PN 400	DDKOR-25S-06S	25 6	46	17	52	37	M36 x 2
	DDKOR-25S-08S	8	19	52	37		
	DDKOR-25S-10S	10	22	53	36.5		
	DDKOR-25S-12S	12	24	53	36.5		
	DDKOR-25S-14S	14	27	55	37		
	DDKOR-25S-16S	16	30	55	36.5		
	DDKOR-25S-20S	20	36	59	37.5		
PN 400	DDKOR-30S-06S	30 6	50	17	54	39	M42 x 2
	DDKOR-30S-08S	8	19	54	39		
	DDKOR-30S-10S	10	22	55	38.5		
	DDKOR-30S-12S	12	24	55	38.5		
	DDKOR-30S-14S	14	27	58	40		
	DDKOR-30S-16S	16	30	58	39.5		
	DDKOR-30S-20S	20	36	61	39.5		
	DDKOR-30S-25S	25	46	64	40		
PN 315	DDKOR-38S-06S	38 6	60	17	58	43	M52 x 2
	DDKOR-38S-08S	8	19	58	43		
	DDKOR-38S-10S	10	22	59	42.5		
	DDKOR-38S-12S	12	24	59	42.5		
	DDKOR-38S-14S	14	27	62	44		
	DDKOR-38S-16S	16	30	62	43.5		
	DDKOR-38S-20S	20	36	65	43.5		
	DDKOR-38S-25S	25	46	68	44		
	DDKOR-38S-30S	30	50	71	44.5		

Dimensions given approximate length with tightened nut. All dimensions are in millimeters, for reference only subject to change. Without male stud, but with pre-settled nut and cutting ring for connection.

DDR

Reducer

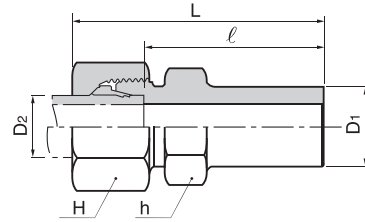

Series	Part No.	Tube O.D. D1	Tube O.D. D2	H	h	L	ℓ
L Light PN 315	DDR-08L-06L	8	6	14	14	40	25.5
	DDR-10L-06L	10	6	14	14	42	27.5
	DDR-10L-08L		8	17	17	43	27.5
	DDR-12L-06L	12	6	14	14	42	27.5
	DDR-12L-08L		8	17	17	43	27.5
	DDR-12L-10L		10	19	17	44	28.5
	DDR-15L-06L	15	6	14	17	44	29
	DDR-15L-08L		8	17	17	44	29
	DDR-15L-10L		10	19	17	45	30
	DDR-15L-12L		12	22	19	45	30
	DDR-18L-06L	18	6	14	19	46	31
	DDR-18L-08L		8	17	19	46	31
	DDR-18L-10L		10	19	19	47	32
	DDR-18L-12L		12	22	19	47	32
	DDR-18L-15L		15	27	24	49	33
PN 160	DDR-22L-06L	22	6	14	24	48	33
	DDR-22L-08L		8	17	24	48	33
	DDR-22L-10L		10	19	24	49	34
	DDR-22L-12L		12	22	24	49	34
	DDR-22L-15L		15	27	24	51	35
	DDR-22L-18L		18	32	27	52	34.5
	DDR-28L-06L	28	6	14	30	48	33
	DDR-28L-08L		8	17	30	48	33
	DDR-28L-10L		10	19	30	50	34
	DDR-28L-12L		12	22	30	50	34
	DDR-28L-15L		15	27	30	52	35
	DDR-28L-18L		18	32	30	53	36
	DDR-28L-22L		22	36	32	57	36.5
	DDR-35L-06L	35	6	14	36	53	38.5
	DDR-35L-08L		8	17	36	53	38.5
	DDR-35L-10L		10	19	36	55	39.5
	DDR-35L-12L		12	22	36	55	39.5
	DDR-35L-15L		15	27	36	58	40.5
	DDR-35L-18L		18	32	36	58	40
	DDR-35L-22L		22	36	36	62	42
	DDR-35L-28L			41	36	63	42
	DDR-42L-06L	42	6	14	46	56	41
	DDR-42L-08L		8	17	46	56	41
	DDR-42L-10L		10	19	46	58	42
	DDR-42L-12L		12	22	46	58	42
	DDR-42L-15L		15	27	46	60	43
	DDR-42L-18L		18	32	46	60	42.5
DDR-42L-22L		22	36	46	62	44.5	
DDR-42L-28L			41	46	64	44.5	
DDR-42L-35L		35	50	46	67	43.5	

Series	Part No.	Tube O.D. D1	Tube O.D. D2	H	h	L	ℓ
S Heavy PN 630	DDR-08S-06S	8	6	17	17	43	28
	DDR-10S-06S	10	6	17	17	45	30.5
	DDR-10S-08S		8	19	17	45	30.5
	DDR-12S-06S	12	6	17	17	47	32.5
	DDR-12S-08S		8	19	17	47	32.5
	DDR-12S-10S		10	22	19	48	32
	DDR-14S-06S	14	6	17	17	51	36.5
	DDR-14S-08S		8	19	17	51	36.5
	DDR-14S-10S		10	22	19	52	36
	DDR-14S-12S		12	24	24	52	36
	DDR-16S-06S	16	6	17	17	53	38.5
	DDR-16S-08S		8	19	17	53	38.5
	DDR-16S-10S		10	22	19	54	38
	DDR-16S-12S		12	24	22	55	38.5
	DDR-16S-14S		14	27	24	57	39.5
PN 400	DDR-20S-06S	20	6	17	22	58	43
	DDR-20S-08S		8	19	22	58	43
	DDR-20S-10S		10	22	22	59	42.5
	DDR-20S-12S		12	24	22	59	42.5
	DDR-20S-14S		14	27	24	62	44
	DDR-20S-16S		16	30	27	62	43.5
	DDR-25S-06S	25	6	17	27	62	47.5
	DDR-25S-08S		8	19	27	62	47.5
	DDR-25S-10S		10	22	27	63	47
	DDR-25S-12S		12	24	27	63	47
	DDR-25S-14S		14	27	27	66	48.5
	DDR-25S-16S		16	30	27	66	48
	DDR-25S-20S		20	36	32	70	48
	DDR-30S-06S	30	6	17	32	67	52
	DDR-30S-08S		8	19	32	67	52
PN 315	DDR-38S-06S	38	6	17	41	72	57
	DDR-38S-08S		8	19	41	72	57
	DDR-38S-10S		10	22	41	73	56.5
	DDR-38S-12S		12	24	41	73	56.5
	DDR-38S-14S		14	27	41	76	58
	DDR-38S-16S		16	30	41	76	57.5
	DDR-38S-20S		20	36	41	79	57.5
	DDR-38S-25S		25	46	41	82	58
	DDR-38S-30S		30	50	46	89	58.5

Dimensions given approximate length with tightened nut. All dimensions are in millimeters, for reference only subject to change.

DDRED

Swivel Reducing Adaptor with Cone

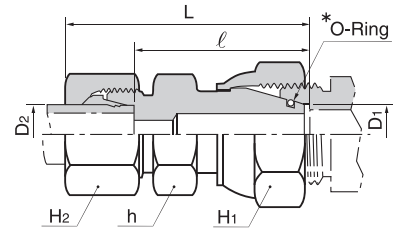

Series L (Light)

Series	Part No.	Tube O.D.		H ₁	H ₂	h	L	l
		D ₁	D ₂					
PN 315	DDRED-08L-06L	8	6	17	14	14	39	24.5
PN 315	DDRED-10L-06L	10	6	19	14	17	39.5	24.5
	DDRED-10L-08L	8			17		39.5	24.5
PN 315	DDRED-12L-06L	12	6	22	14	17	40	25
	DDRED-12L-08L	8			17		40	25
	DDRED-12L-10L	10			19		41	26
PN 315	DDRED-15L-06L	15	6	27	14	22	42	27.5
	DDRED-15L-08L	8			17		42	27.5
	DDRED-15L-10L	10			19		43	28.5
	DDRED-15L-12L	12			22		43	28.5
PN 315	DDRED-18L-06L	18	6	32	14	25	43	28
	DDRED-18L-08L	8			17		43	28
	DDRED-18L-10L	10			19		44.5	29.5
	DDRED-18L-12L	12			22		44.5	29.5
	DDRED-18L-15L	15			27		45.5	30.5
PN 160	DDRED-22L-06L	22	6	36	14	28.5	47	32
	DDRED-22L-08L	8			17		47	32
	DDRED-22L-10L	10			19		48	33
	DDRED-22L-12L	12			22		48	33
	DDRED-22L-15L	15			27		49	34
	DDRED-22L-18L	18			32		50	33.5
PN 160	DDRED-28L-06L	28	6	41	14	36	49	34
	DDRED-28L-08L	8			17		49	34
	DDRED-28L-10L	10			19		50	35
	DDRED-28L-12L	12			22		50	35
	DDRED-28L-15L	15			27		51	36
	DDRED-28L-18L	18			32		52	35.5
	DDRED-28L-22L	22			36		54	37.5
PN 160	DDRED-35L-06L	35	6	50	14	46	55	40
	DDRED-35L-08L	8			17		55	40
	DDRED-35L-10L	10			19		56	41
	DDRED-35L-12L	12			22		56	41
	DDRED-35L-15L	15			27		57	42
	DDRED-35L-18L	18			32		58	41.5
	DDRED-35L-22L	22			36		60	43.5
	DDRED-35L-28L	28			41		60	43.5
PN 160	DDRED-42L-06L	42	6	60	14	50	55	40.5
	DDRED-42L-08L	8			17		55	40.5
	DDRED-42L-10L	10			19		56	41.5
	DDRED-42L-12L	12			22		56	41.5
	DDRED-42L-15L	15			27		58	42.5
	DDRED-42L-18L	18			32		58	42
	DDRED-42L-22L	22			36		60	44
	DDRED-42L-28L	28			41		61	44
	DDRED-42L-35L	35			50		65	43

Series S (Heavy)

Series	Part No.	Tube O.D.		H ₁	H ₂	h	L	l
		D ₁	D ₂					
PN 630	DDRED-08S-06S	8	6	19	17	17	44	28
PN 630	DDRED-10S-06S	10	6	22	17	17	44	29.5
	DDRED-10S-08S	8			19		44	29.5
PN 630	DDRED-12S-06S	12	6	24	17	19	45	30
	DDRED-12S-08S	8			19		45	30
	DDRED-12S-10S	10			22		46	29.5
PN 630	DDRED-14S-06S	14	6	27	17	22	47.5	33
	DDRED-14S-08S	8			19		47.5	33
	DDRED-14S-10S	10			22		48.5	32.5
	DDRED-14S-12S	12			24		48.5	32.5
PN 630	DDRED-16S-06S	16	6	30	17	24	50.0	35
	DDRED-16S-08S	8			19		50	35
	DDRED-16S-10S	10			22		51	34.5
	DDRED-16S-12S	12			24		51	34.5
	DDRED-16S-14S	14			27		54	36
PN 400	DDRED-20S-06S	20	6	36	17	28.5	54	39
	DDRED-20S-08S	8			19		54	39
	DDRED-20S-10S	10			22		55	38.5
	DDRED-20S-12S	12			24		55	38.5
	DDRED-20S-14S	14			27		58	40
	DDRED-20S-16S	16			30		58	39.5
PN 400	DDRED-25S-06S	25	6	46	17	36	58	43.5
	DDRED-25S-08S	8			19		58	43.5
	DDRED-25S-10S	10			22		59	43
	DDRED-25S-12S	12			24		59	43
	DDRED-25S-14S	14			27		62	44.5
	DDRED-25S-16S	16			30		62	44
	DDRED-25S-20S	20			36		66	44
PN 400	DDRED-30S-06S	30	6	50	17	41	66	51
	DDRED-30S-08S	8			19		66	51
	DDRED-30S-10S	10			22		67	50.5
	DDRED-30S-12S	12			24		67	50.5
	DDRED-30S-14S	14			27		70	52
	DDRED-30S-16S	16			30		70	51.5
	DDRED-30S-20S	20			36		73	51.5
	DDRED-30S-25S	25			46		76	52
PN 315	DDRED-38S-06S	38	6	60	17	50	70.5	56
	DDRED-38S-08S	8			19		70.5	56
	DDRED-38S-10S	10			22		71.5	55.5
	DDRED-38S-12S	12			24		71.5	55.5
	DDRED-38S-14S	14			27		74.5	57
	DDRED-38S-16S	16			30		74.5	56.5
	DDRED-38S-20S	20			36		78.5	56.5
	DDRED-38S-25S	25			46		81.5	57
	DDRED-38S-30S	30			50		85.5	58.5

Dimensions given approximate length with tightened nut. All dimensions are in millimeters, for reference only subject to change.

Without male stud, but supplied with fitted O-Ring for connection.

*O-ring of NBR Standard, of FPM(e.g Viton®) on request.

DDA-GED/MED

Adaptor (BSP Parallel/Metric Parallel) with *ED-Ring

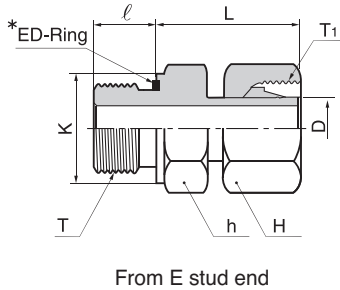

for BSP Parallel

Series	Part No.	Tube O.D. D	H	h	K	L	ℓ	T G(PF)	T ₁
L Light PN 315	DDA-06L-01GED	6	14	14	14	24.5	8	1/8	M12 x 1.5
	DDA-08L-02GED	8	17	19	19	29.5	12	1/4	M14 x 1.5
	DDA-10L-02GED	10	19	19	19	27.5	12	1/4	M16 x 1.5
	DDA-12L-03GED	12	22	22	22	34	12	3/8	M18 x 1.5
	DDA-15L-04GED	15	27	27	27	32	14	1/2	M22 x 1.5
	DDA-18L-04GED	18	32	27	27	31.5	14	1/2	M26 x 1.5
PN 160	DDA-22L-06GED	22	36	32	32	32.5	16	3/4	M30 x 2
	DDA-28L-08GED	28	41	41	40	35	18	1	M36 x 2
	DDA-35L-10GED	35	50	50	50	42.5	20	1-1/4	M45 x 2
	DDA-42L-12GED	42	60	55	55	46.5	22	1-1/2	M52 x 2
S Heavy PN 630	DDA-06S-02GED	6	17	19	19	27	12	1/4	M14 x 1.5
	DDA-08S-02GED	8	19	19	19	29.5	12	1/4	M16 x 1.5
	DDA-10S-03GED	10	22	22	22	32	12	3/8	M18 x 1.5
	DDA-12S-03GED	12	24	22	22	34	12	3/8	M20 x 1.5
	DDA-12S-04GED	12	24	27	27	34.5	14	1/2	M20 x 1.5
	DDA-14S-04GED	14	27	27	27	36.5	14	1/2	M22 x 1.5
PN 400	DDA-16S-04GED	16	30	27	27	37	14	1/2	M24 x 1.5
	DDA-16S-06GED	16	30	32	32	39	16	3/4	M24 x 1.5
	DDA-20S-06GED	20	36	32	32	43	16	3/4	M30 x 2
	DDA-25S-08GED	25	46	41	40	48	18	1	M36 x 2
	DDA-30S-10GED	30	50	50	50	51	20	1-1/4	M42 x 2
	DDA-38S-12GED	38	60	55	55	60	22	1-1/2	M52 x 2

for Metric Parallel

Series	Part No.	Tube O.D. D	H	h	K	L	ℓ	T M(Metric)	T ₁
L Light PN 315	DDA-06L-M10ED	6	14	14	14	24.5	8	M10 x 1	M12 x 1.5
	DDA-08L-M12ED	8	17	17	17	26.5	12	M12 x 1.5	M14 x 1.5
	DDA-10L-M14ED	10	19	19	19	27.5	12	M14 x 1.5	M16 x 1.5
	DDA-12L-M16ED	12	22	22	22	30.5	12	M16 x 1.5	M18 x 1.5
	DDA-15L-M18ED	15	27	24	24	31.5	14	M18 x 1.5	M22 x 1.5
	DDA-18L-M22ED	18	32	27	27	31.5	14	M22 x 1.5	M26 x 1.5
PN 160	DDA-22L-M26ED	22	36	32	32	32.5	16	M26 x 1.5	M30 x 2
	DDA-28L-M33ED	28	41	41	40	35	18	M33 x 2	M36 x 2
	DDA-35L-M42ED	35	50	50	50	42.5	20	M42 x 2	M45 x 2
	DDA-42L-M48ED	42	60	55	55	46.5	22	M48 x 2	M52 x 2
S Heavy PN 630	DDA-06S-M12ED	6	17	17	17	27	12	M12 x 1.5	M14 x 1.5
	DDA-08S-M14ED	8	19	19	19	29.5	12	M14 x 1.5	M16 x 1.5
	DDA-10S-M16ED	10	22	22	22	32	12	M16 x 1.5	M18 x 1.5
	DDA-12S-M18ED	12	24	24	24	34	12	M18 x 1.5	M20 x 1.5
	DDA-14S-M20ED	14	27	27	27	36.5	14	M20 x 1.5	M22 x 1.5
PN 400	DDA-16S-M22ED	16	30	27	27	37	14	M22 x 1.5	M24 x 1.5
	DDA-20S-M27ED	20	36	32	32	43	16	M27 x 2	M30 x 2
	DDA-25S-M33ED	25	46	41	40	48	18	M33 x 2	M36 x 2
	DDA-30S-M42ED	30	50	50	50	51	20	M42 x 2	M45x 2
PN 315	DDA-38S-M48ED	38	60	55	55	60	22	M48 x 2	M52x 2

Dimensions given approximate length with tightened nut. All dimensions are in millimeters, for reference only subject to change. Without male stud, but with pre-set nut and cutting ring for connection.

*ED-ring of NBR Standard, of FPM(e.g Viton®) on request.

DDEGE-G/M

Swivel Adaptor (BSP Parallel/Metric Parallel) with *ED-Ring

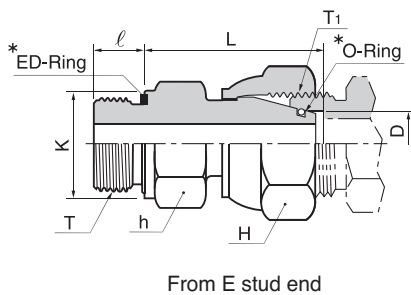
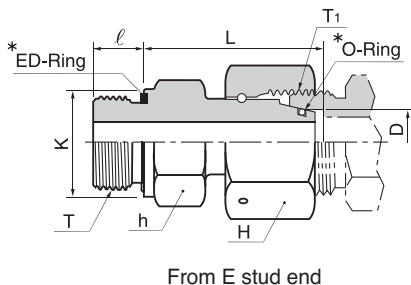
*for BSP Parallel*

Series	Part No.	Tube O.D. D	H	h	K	L	ℓ	T G(PF)	T ₁
L Light PN 315	DDEGE-06L-01G	6	14	14	14	24.5	8	1/8	M12 x 1.5
	DDEGE-08L-02G	8	17	19	19	29.5	12	1/4	M14 x 1.5
	DDEGE-10L-02G	10	19	19	19	27.5	12	1/4	M16 x 1.5
	DDEGE-12L-03G	12	22	22	22	34	12	3/8	M18 x 1.5
	DDEGE-15L-04G	15	27	27	27	32	14	1/2	M22 x 1.5
	DDEGE-18L-04G	18	32	27	27	31.5	14	1/2	M26 x 1.5
PN 160	DDEGE-22L-06G	22	36	32	32	32.5	16	3/4	M30 x 2
	DDEGE-28L-08G	28	41	41	40	35	18	1	M36 x 2
	DDEGE-35L-10G	35	50	50	50	42.5	20	1-1/4	M45 x 2
	DDEGE-42L-12G	42	60	55	55	46.5	22	1-1/2	M52 x 2
S Heavy PN 630	DDEGE-06S-02G	6	17	19	19	27	12	1/4	M14 x 1.5
	DDEGE-08S-02G	8	19	19	19	29.5	12	1/4	M16 x 1.5
	DDEGE-10S-03G	10	22	22	22	32	12	3/8	M18 x 1.5
	DDEGE-12S-03G	12	24	22	22	34	12	3/8	M20 x 1.5
	DDEGE-14S-04G	14	27	27	27	36.5	14	1/2	M22 x 1.5
PN 400	DDEGE-16S-04G	16	30	27	27	37	14	1/2	M24 x 1.5
	DDEGE-20S-06G	20	36	32	32	43	16	3/4	M30 x 2
	DDEGE-25S-08G	25	46	41	40	48	18	1	M36 x 2
	DDEGE-30S-10G	30	50	50	50	51	20	1-1/4	M42 x 2
PN 315	DDEGE-38S-12G	38	60	55	55	60	22	1-1/2	M52 x 2

for Metric Parallel

Series	Part No.	Tube O.D. D	H	h	K	L	ℓ	T M(Metric)	T ₁
L Light PN 315	DDEGE-06L-M10	6	14	14	14	24.5	8	M10 x 1	M12 x 1.5
	DDEGE-08L-M12	8	17	19	17	26.5	12	M12 x 1.5	M14 x 1.5
	DDEGE-10L-M14	10	19	19	19	27.5	12	M14 x 1.5	M16 x 1.5
	DDEGE-12L-M16	12	22	22	22	30.5	12	M16 x 1.5	M18 x 1.5
	DDEGE-15L-M18	15	27	24	24	31.5	12	M18 x 1.5	M22 x 1.5
	DDEGE-18L-M22	18	32	27	27	31.5	14	M22 x 1.5	M26 x 1.5
PN 160	DDEGE-22L-M26	22	36	32	32	32.5	16	M26 x 1.5	M30 x 2
	DDEGE-28L-M33	28	41	41	40	35	18	M33 x 2	M36 x 2
	DDEGE-35L-M42	35	50	50	50	42.5	20	M42 x 2	M45 x 2
	DDEGE-42L-M48	42	60	55	55	46.5	22	M48 x 2	M52 x 2
S Heavy PN 630	DDEGE-06S-M12	6	17	17	17	27	12	M12 x 1.5	M14 x 1.5
	DDEGE-08S-M14	8	19	19	19	29.5	12	M14 x 1.5	M16 x 1.5
	DDEGE-10S-M16	10	22	22	22	32	12	M16 x 1.5	M18 x 1.5
	DDEGE-12S-M18	12	24	24	24	34	12	M18 x 1.5	M20 x 1.5
	DDEGE-14S-M20	14	27	27	26	36.5	14	M20 x 1.5	M22 x 1.5
PN 400	DDEGE-16S-M22	16	30	27	27	37	14	M22 x 1.5	M24 x 1.5
	DDEGE-20S-M27	20	36	32	32	43	16	M27 x 2	M30 x 2
	DDEGE-25S-M33	25	46	41	40	48	18	M33 x 2	M36 x 2
	DDEGE-30S-M42	30	50	50	50	51	20	M42 x 2	M42 x 2
PN 315	DDEGE-38S-M48	38	60	55	55	60	22	M48 x 2	M52 x 2

Dimensions given approximate length with tightened nut. All dimensions are in millimeters, for reference only subject to change.
Without male stud, but supplied with fitted O-Ring for connection.

*O-ring of NBR Standard, of FPM(e.g Viton®) on request.

DDUE

Swivel Union with Cone

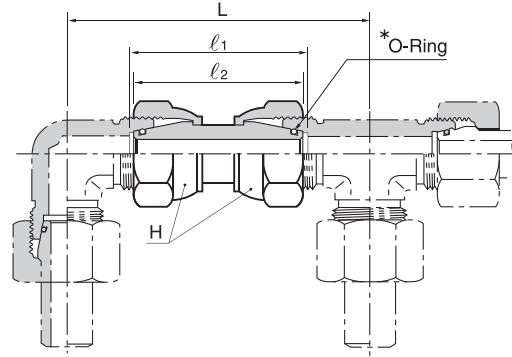

Series	Part No.	Tube O.D.	H	L	l ₁	l ₂
L Light PN 500	DDUE-06L	6	17	64	36	34
	DDUE-08L	8	17	64	36	34
	DDUE-10L	10	19	67	37	36
PB 400	DDUE-12L	12	22	71	37	36
	DDUE-15L	15	27	82	40	39
	DDUE-18L	18	32	89.5	42.5	40.5
PB 250	DDUE-22L	22	36	102	47	45
	DDUE-28L	28	46	110	49	47
	DDUE-35L	35	50	127	58	53
	DDUE-42L	42	60	139	59	53
S Heavy PB 800	DDUE-06S	6	17	71	39	37
	DDUE-08S	8	19	73	39	37
	DDUE-10S	10	22	78	43	41
PN 630	DDUE-12S	12	24	87	44	43
	DDUE-14S	14	27	92	48	45
	DDUE-16S	16	30	99	50	46
PN 400	DDUE-20S	20	36	113	60	55
	DDUE-25S	26	46	126	66	58
	DDUE-30S	30	50	144	73	62
	DDUE-38S	38	60	165	83	67

Dimensions given approximate length with tightened nut. All dimensions are in millimeters, for reference only subject to change.

Without male stud, but supplied with fitted O-Ring for connection.

*O-ring of NBR Standard, of FPM(e.g Viton®) on request.

DDSWVE-G/M

Banjo Fittings
(BSP Parallel/Metric Parallel)
with DKA-Ring

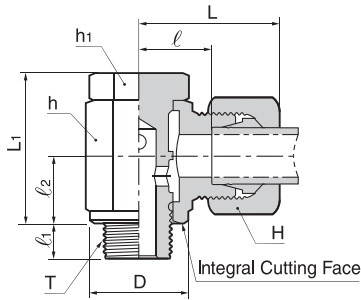

For Tube O.D up to 15mm

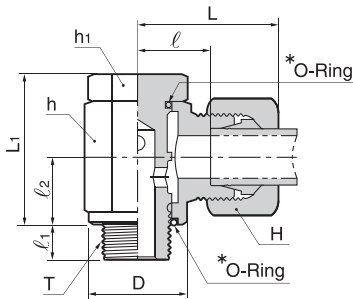

For Tube O.D 16mm and larger

for BSP Parallel

Series	Part No.	Tube O.D.	D	H	h	h ₁	L	L ₁	l	l ₁	l ₂	T G(PF)	MA*
L Light PB 250	DDSWVE-06L-01G	6	14.5	14	14	14	25	21	10.5	6	10	1/8	20
	DDSWVE-08L-02G	8	18.5	17	19	19	28	27	13	9	13	1/4	45
	DDSWVE-10L-02G	10	18.5	19	19	19	29	27	14	9	13	1/4	45
	DDSWVE-12L-03G	12	22.5	22	22	22	30	32	15.5	9	15	3/8	70
	DDSWVE-15L-04G	15	26.5	27	27	27	34	37.5	19	11	18	1/2	100
PB 160	DDSWVE-18L-04G	18	26	32	30	27	37	44	20.5	11	21.5	1/2	100
	DDSWVE-22L-06G	22	32	36	36	32	42	49	25.5	13	24	3/4	140
S Heavy PB 250	DDSWVE-06S-02G	6	18.5	17	19	19	30	27	15	9	13	1/4	45
	DDSWVE-08S-02G	8	18.5	19	19	19	30	27	15	9	13	1/4	45
	DDSWVE-10S-03G	10	22.5	22	22	22	32	32	16	9	15	3/8	70
	DDSWVE-12S-03G	12	22.5	24	24	24	33	37	17	9	18	3/8	70
	DDSWVE-14S-04G	14	26.5	27	27	27	38	37	20	11	18	1/2	100
PB 160	DDSWVE-16S-04G	16	26	30	30	27	40	44	21.5	11	21.5	1/2	100
	DDSWVE-20S-06G	20	32	36	36	32	46	49	24.5	13	24	3/4	140

for Metric Parallel

Series	Part No.	Tube O.D.	D	H	h	h ₁	L	L ₁	l	l ₁	l ₂	T M(Metric)	MA*
L Light PB 250	DDSWVE-06L-M10	6	14.5	14	14	14	25	21.5	10.5	6	10	M10 x 1	25
	DDSWVE-08L-M12	8	17.5	17	17	17	27	25	12	9	12	M12 x 1.5	40
	DDSWVE-10L-M14	10	19.5	19	19	19	29	27	14	9	13	M14 x 1.5	55
	DDSWVE-12L-M16	12	21.5	22	22	22	30	32	15.5	9	15	M16 x 1.5	65
	DDSWVE-15L-M18	15	23.5	27	24	24	33	37.5	17.5	9	18	M18 x 1.5	90
PB 160	DDSWVE-18L-M22	18	27	32	30	27	37	44	20.5	11	21.5	M22 x 1.5	130
	DDSWVE-22L-M26	22	31	36	36	32	42	49	25.5	13	24	M26 x 1.5	140
S Heavy PB 250	DDSWVE-06S-M12	6	17.5	17	17	17	29	25	14	9	12	M12 x 1.5	40
	DDSWVE-08S-M14	8	19.5	19	19	19	30	27	15	9	13	M14 x 1.5	55
	DDSWVE-10S-M16	10	21.5	22	22	22	32	32	16	9	15	M16 x 1.5	65
	DDSWVE-12S-M18	12	23.5	24	24	24	33	37	17	9	18	M18 x 1.5	90
	DDSWVE-14S-M20	14	25.5	27	27	27	38	37	20	11	18	M20 x 1.5	120
PB 160	DDSWVE-16S-M22	16	27	30	30	27	40	44	21.5	11	21.5	M22 x 1.5	130
	DDSWVE-20S-M27	20	32	36	36	32	46	49	24.5	13	24	M27 x 2	150

Dimensions given approximate length with tightened nut. All dimensions are in millimeters, for reference only subject to change.

*MA = Recommended tightening torques (in Nm) for male G and M.

*O-ring of NBR Standard, of FPM(e.g Viton®) on request.

DDWH-G/M

High Pressure Banjo Fittings
(BSP Parallel/Metric Parallel)
with DKA-Ring

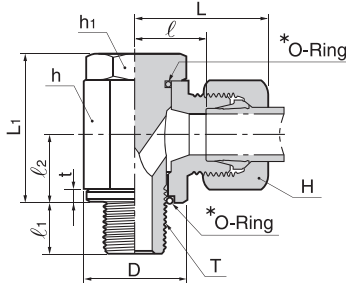

for BSP Parallel

Series	Part No.	Tube O.D.	D	H	h	h ₁	L	L ₁	l	l ₁	l ₂	t	T G(PF)	MA*
L Light PB 315	DDWH-06L-01G	6	14	14	17	17	27	24	12	8	10.5	2.5	1/8	20
	DDWH-08L-02G	8	18	17	22	19	29	30	14.5	12	14	3.0	1/4	50
	DDWH-10L-02G	10	18	19	22	19	30	30	15.5	12	14	3.0	1/4	50
	DDWH-12L-03G	12	22	22	27	24	33	36	18	12	16.5	3.0	3/8	75
	DDWH-15L-04G	15	26	27	32	30	37	45	21.5	14	21.5	4.5	1/2	130
	DDWH-18L-04G	18	26	32	32	30	37	45	21	14	21.5	4.5	1/2	130
PB 160	DDWH-22L-06G	22	32	36	41	36	44	53	27.5	16	24	3.5	3/4	250
	DDWH-28L-08G	28	39	41	50	46	49	66	32	18	30.5	3.5	1	350
	DDWH-35L-10G	35	49	50	60	55	58	76	36	20	35.5	3.5	1-1/4	600
	DDWH-42L-12G	42	55	60	70	60	63	87	40.5	22	40.5	3.5	1-1/2	800
S Heavy PB 400	DDWH-06S-02G	6	18	17	22	19	31	30	16.5	12	14	3.0	1/4	50
	DDWH-08S-02G	8	18	19	22	19	31	30	16.5	12	14	3.0	1/4	50
	DDWH-10S-03G	10	22	22	27	24	35	36	18.5	12	16.5	3.0	3/8	75
	DDWH-12S-03G	12	22	24	27	24	35	36	18.5	12	16.5	3.0	3/8	75
	DDWH-16S-04G	16	26	30	32	30	40	45	22	14	21.5	4.5	1/2	130
	DDWH-20S-06G	20	32	36	41	36	48	53	26.5	16	24	3.5	3/4	250
PB 250	DDWH-25S-08G	25	39	46	50	46	56	66	31.5	18	30.5	3.5	1	350
	DDWH-30S-10G	30	49	50	60	55	64	76	37	20	34.5	3.5	1-1/4	600
	DDWH-38S-12G	38	55	60	70	60	72	87	41.5	22	40.5	3.5	1-1/2	800

for Metric Parallel

Series	Part No.	Tube O.D.	D	H	h	h ₁	L	L ₁	l	l ₁	l ₂	t	T M(Metric)	MA*
L Light PB 315	DDWH-06L-M10	6	14	14	17	17	27	24	12	8	10.5	2.5	M10 x 1	25
	DDWH-08L-M12	8	17	17	22	19	29	30	14.5	12	14	3.0	M12 x 1.5	50
	DDWH-10L-M14	10	19	19	22	19	30	30	15.5	12	14	3.0	M14 x 1.5	60
	DDWH-12L-M16	12	21	22	27	24	33	36	18	12	16.5	3.0	M16 x 1.5	90
	DDWH-15L-M18	15	23	27	30	27	36	39.5	20.5	12	18.5	3.0	M18 x 1.5	110
	DDWH-18L-M22	18	27	32	32	30	37	45	21	14	21.5	4.5	M22 x 1.5	150
PB 160	DDWH-22L-M26	22	31	36	41	36	44	53	27.5	16	24	3.5	M26 x 1.5	350
	DDWH-28L-M33	28	39	41	50	46	49	66	32	18	30.5	3.5	M33 x 2	400
	DDWH-35L-M42	35	49	50	60	55	58	76	36	20	35.5	3.5	M42 x 2	600
	DDWH-42L-M48	42	55	60	70	60	63	87	40.5	22	40.5	3.5	M48 x 2	800
S Heavy PB 400	DDWH-06S-M12	6	17	17	22	19	31	30	16.5	12	14	3.0	M12 x 1.5	50
	DDWH-08S-M14	8	19	19	22	19	31	30	16.5	12	14	3.0	M14 x 1.5	60
	DDWH-10S-M16	10	21	22	27	24	35	36	18.5	12	16.5	3.0	M16 x 1.5	90
	DDWH-12S-M18	12	23	24	30	27	36	39.5	20	12	18.5	3.0	M18 x 1.5	110
	DDWH-16S-M22	16	27	30	32	30	40	45	22	14	21.5	4.5	M22 x 1.5	150
	DDWH-20S-M27	20	32	36	41	36	48	53	26.5	16	24	3.5	M27 x 2	350
PB 250	DDWH-25S-M33	25	39	46	50	46	56	66	31.5	18	30.5	3.5	M33 x 2	400
	DDWH-30S-M42	30	49	50	60	55	64	76	37	20	35.5	3.5	M42 x 2	600
	DDWH-38S-M48	38	55	60	70	60	72	87	41.5	22	40.5	3.5	M48 x 2	800

Dimensions given approximate length with tightened nut. All dimensions are in millimeters, for reference only subject to change.

*MA = Recommended tightening torques (in Nm) for male G and M.

*O-ring of NBR Standard, of FPM(e.g Viton®) on request.

DDTH-G/M

High Pressure Banjo Fittings
(BSP Parallel/Metric Parallel)

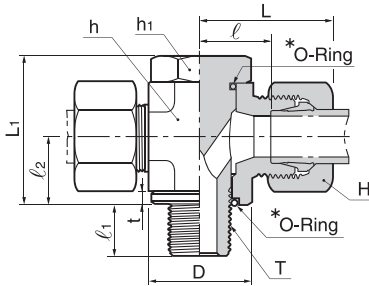

for BSP Parallel

Series	Part No.	Tube O.D.	D	H	h	h ₁	L	L ₁	l	l ₁	l ₂	t	T G(PF)	MA*
L Light PB 315	DDTH-06L-01G	6	14	14	17	17	27	24	12	8	10.5	2.5	1/8	20
	DDTH-08L-02G	8	18	17	22	19	29	30	14.5	12	14	3.0	1/4	50
	DDTH-10L-02G	10	18	19	22	19	30	30	15.5	12	14	3.0	1/4	50
	DDTH-12L-03G	12	22	22	27	24	33	36	18	12	16.5	3.0	3/8	75
	DDTH-15L-04G	15	26	27	32	30	37	45	21.5	14	21.5	4.5	1/2	130
	DDTH-18L-04G	18	26	32	32	30	37	45	21	14	21.5	4.5	1/2	130
PB 160	DDTH-22L-06G	22	32	36	41	36	44	53	27.5	16	24	3.5	3/4	250
	DDTH-28L-08G	28	39	41	50	46	49	66	32	18	30.5	3.5	1	350
	DDTH-35L-10G	35	49	50	60	55	58	76	36	20	35.5	3.5	1-1/4	600
	DDTH-42L-12G	42	55	60	70	60	63	87	40.5	22	40.5	3.5	1-1/2	800
S Heavy PB 400	DDTH-06S-02G	6	18	17	22	19	31	30	16.5	12	14	3.0	1/4	50
	DDTH-08S-02G	8	18	19	22	19	31	30	16.5	12	14	3.0	1/4	50
	DDTH-10S-03G	10	22	22	27	24	35	36	18.5	12	16.5	3.0	3/8	75
	DDTH-12S-03G	12	22	24	27	24	35	36	18.5	12	16.5	3.0	3/8	75
	DDTH-16S-04G	16	26	30	32	30	40	45	22	14	21.5	4.5	1/2	130
	DDTH-20S-06G	20	32	36	41	36	48	53	26.5	16	24	3.5	3/4	250
PB 250	DDTH-25S-08G	25	39	46	50	46	56	66	31.5	18	30.5	3.5	1	350
	DDTH-30S-10G	30	49	50	60	55	64	76	37	20	35.5	3.5	1-1/4	600
	DDTH-38S-12G	38	55	60	70	60	72	87	41.5	22	40.5	3.5	1-1/2	800

for Metric Parallel

Series	Part No.	Tube O.D.	D	H	h	h ₁	L	L ₁	l	l ₁	l ₂	t	T M(Metric)	MA*
L Light PB 315	DDTH-06L-M10	6	14	14	17	17	27	24	12	8	10.5	2.5	M10 x 1	25
	DDTH-08L-M12	8	17	17	22	19	29	30	14.5	12	14	3.0	M12 x 1.5	50
	DDTH-10L-M14	10	19	19	22	19	30	30	15.5	12	14	3.0	M14 x 1.5	60
	DDTH-12L-M16	12	21	22	27	24	33	36	18	12	16.5	3.0	M16 x 1.5	90
	DDTH-15L-M18	15	23	27	30	27	36	39.5	20.5	12	18.5	3.0	M18 x 1.5	110
	DDTH-18L-M22	18	27	32	32	30	37	45	21	14	21.5	4.5	M22 x 1.5	150
PB 160	DDTH-22L-M26	22	31	36	41	36	44	53	27.5	16	24	3.5	M26 x 1.5	350
	DDTH-28L-M33	28	39	41	50	46	49	66	32	18	30.5	3.5	M33 x 2	400
	DDTH-35L-M42	35	49	50	60	55	58	76	36	20	35.5	3.5	M42 x 2	600
	DDTH-42L-M48	42	55	60	70	60	63	87	40.5	22	40.5	3.5	M48 x 2	800
S Heavy PB 400	DDTH-06S-M12	6	17	17	22	19	31	30	16.5	12	14	3.0	M12 x 1.5	50
	DDTH-08S-M14	8	19	19	22	19	31	30	16.5	12	14	3.0	M14 x 1.5	60
	DDTH-10S-M16	10	21	22	27	24	35	36	18.5	12	16.5	3.0	M16 x 1.5	90
	DDTH-12S-M18	12	23	24	30	27	36	39.5	20	12	18.5	3.0	M18 x 1.5	110
	DDTH-16S-M22	16	27	30	32	30	40	45	22	14	21.5	4.5	M22 x 1.5	150
	DDTH-20S-M27	20	32	36	41	36	48	53	26.5	16	24	3.5	M27 x 2	350
PB 250	DDTH-25S-M33	25	39	46	50	46	56	66	31.5	18	30.5	3.5	M33 x 2	400
	DDTH-30S-M42	30	49	50	60	55	64	76	37	20	35.5	3.5	M42 x 2	600
	DDTH-38S-M48	38	55	60	70	60	72	87	41.5	22	40.5	3.5	M48 x 2	800

Dimensions given approximate length with tightened nut. All dimensions are in millimeters, for reference only subject to change.
 *MA = Recommended tightening torques (in Nm) for male G and M.
 *O-ring of NBR Standard, of FPM(e.g Viton®) on request.

DDGC-G

Pressure Gauge Connector (BSP Parallel) with DKI-Ring

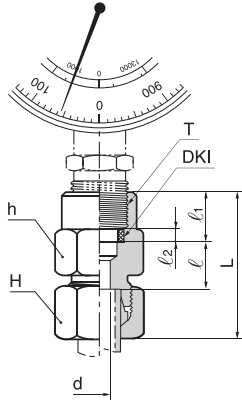

Series	Part No.	Tube O.D.	d	H	h	L	l ₁	l ₂	T G(PF)	
L Light PN 315	DDGC-06L-02G	6	2.5	14	19	37	7.5	14.5	4.5	1/4
	DDGC-08L-02G	8	5.5	17	19	37	7.5	14.5	4.5	1/4
	DDGC-10L-02G	10	5.5	19	19	38	8.5	14.5	4.5	1/4
	DDGC-12L-02G	12	5.5	22	19	38	8.5	14.5	4.5	1/4
S Heavy PN 630	DDGC-06S-04G	6	3.5	17	27	46	11	20	5	1/2
	DDGC-08S-04G	8	3.5	19	27	46	11	20	5	1/2
	DDGC-10S-04G	10	7.0	22	27	47	10.5	20	5	1/2
	DDGC-12S-04G	12	7.0	24	27	47	10.5	20	5	1/2

Dimensions given approximate length with tightened nut. All dimensions are in millimeters, for reference only subject to change.

DDGE-G

Swivel Gauge Adaptor (BSP Parallel) with cone and DKI-Ring

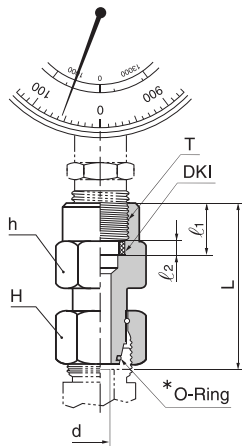

Series	Part No.	Tube O.D.	d	H	h	L	l ₁	l ₂	T G(PF)
L Light PN 315	DDGE-06L-02G	6	2.5	14	19	35.5	14.5	4.5	1/4
	DDGE-08L-02G	8	4	17		35.5			
	DDGE-10L-02G	10	5.5	19		36			
	DDGE-12L-02G	12	5.5	22		36			
S Heavy PN 630	DDGE-06S-04G	6	2.5	17	27	42.5	20	5	1/2
	DDGE-08S-04G	8	4	19		43			
	DDGE-10S-04G	10	6	22		43.5			
	DDGE-12S-04G	12	7	24		45			
	DDGE-06S-02G	6	2.5	17	19	35.5	14.5	4.5	1/4
	DDGE-08S-02G	8	4	19		35.5			
	DDGE-10S-02G	10	6	22		36			
	DDGE-12S-02G	12	7	24		39			

Dimensions given approximate length with tightened nut. All dimensions are in millimeters, for reference only subject to change.
*O-ring of NBR Standard, of FPM(e.g Viton®) on request.

DDGA-G

Gauge Connector (BSP Parallel) with Standpipe and DKI-Ring

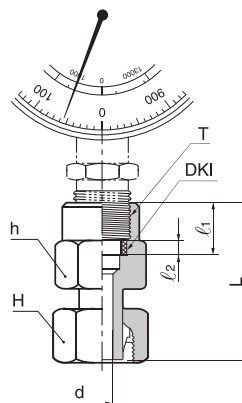

Series	Part No.	Tube O.D.	d	H	h	L	l ₁	l ₂	T G(PF)
L Light PN 315	DDGA-06L-02G	6	3.5	14	19	38	14.5	4.5	1/4
	DDGA-08L-02G	8	5.5	17		38			
	DDGA-10L-02G	10	7.5	19		39.5			
	DDGA-12L-02G	12	9	22		40.5			
S Heavy PN 630	DDGA-06S-04G	6	3.5	17	27	45	20	5	1/2
	DDGA-08S-04G	8	4.5	19		45			
	DDGA-10S-04G	10	6.5	22		47			
	DDGA-12S-04G	12	7.5	24		47.5			

All dimensions are in millimeters, for reference only subject to change.

DDGMA

Tee Test Coupling with threaded Connection DEMA 3-02G

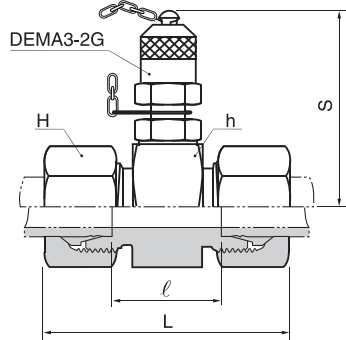

Series	Part No.	Tube O.D.	H	h	L	l	S
L Light PB 315	DDGMA-3-06L	6	14	24	50	20.5	50
	DDGMA-3-08L	8	17	24	50	20.5	50
	DDGMA-3-10L	10	19	24	52	22.5	50
	DDGMA-3-12L	12	22	24	52	22.5	50
	DDGMA-3-15L	15	27	30	55	24.5	53
	DDGMA-3-18L	18	32	32	56	23.5	54
PB 160	DDGMA-3-22L	22	36	36	60	27.5	56
	DDGMA-3-28L	28	41	41	61	27.5	58
	DDGMA-3-35L	35	50	46	69	25.5	61
	DDGMA-3-42L	42	60	55	70	24.5	65
S Heavy PB 630	DDGMA-3-06S	6	17	24	54	24.5	50
	DDGMA-3-08S	8	19	24	54	24.5	50
	DDGMA-3-10S	10	22	24	56	23.5	50
	DDGMA-3-12S	12	24	24	56	23.5	50
	DDGMA-3-14S	14	27	27	62	26.5	51
PB 400	DDGMA-3-16S	16	30	30	62	25.5	53
	DDGMA-3-20S	20	36	36	69	25.5	56
	DDGMA-3-25S	25	46	41	75	26.5	58
	DDGMA-3-30S	30	50	46	81	27.5	61
PB 315	DDGMA-3-38S	38	60	55	90	29	65

Dimensions given approximate length with tightened nut. All dimensions are in millimeters, for reference only subject to change.

DDEMA3

Test Coupling with threaded Connection M16

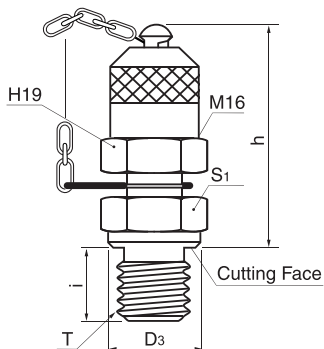

From B stud end standard
(From E stud end available)

Series	Part No.	D ₃	h	i	S ₁	T
PB 630	DDEMA3-01G	14	41	8	17	PF 1/8
	DDEMA3-02G	18	41	10	19	PF 1/4
	DDEMA3-03G	22	41	12	22	PF 3/8
	DDEMA3-04G	26	41	14	27	PF 1/2
PB 630	DDEMA3-M10	14	41	8	17	M10 x 1
	DDEMA3-M12	17	41	12	17	M12 x 1.5
	DDEMA3-M14	19	41	12	19	M14 x 1.5
	DDEMA3-M16	21	41	12	22	M16 x 1.5

Dimensions given approximate length with tightened nut. All dimensions are in millimeters, for reference only subject to change.

DDAS

Welding Connector

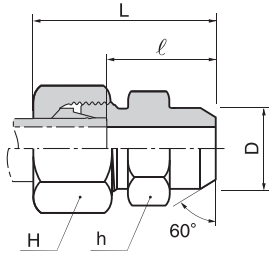

Series	Part No.	Tube O.D.	D	H	h	L	l
L Light PN 315	DDAS-06L	6	10	14	12	29	14
	DDAS-08L	8	12	17	14	31	16
	DDAS-10L	10	14	19	17	33	18
	DDAS-12L	12	16	22	19	33	18
	DDAS-15L	15	19	27	22	37	22
	DDAS-18L	18	22	32	27	40	23.5
PN 160	DDAS-22L	22	27	36	32	45	28.5
	DDAS-28L	28	32	41	41	47	30.5
	DDAS-35L	35	40	50	46	54	32.5
	DDAS-42L	42	46	60	55	58	35
S Heavy PN 630	DDAS-06S	6	11	17	14	34	19
	DDAS-08S	8	13	19	17	36	21
	DDAS-10S	10	15	22	19	39	22.5
	DDAS-12S	12	17	24	22	41	24.5
	DDAS-14S	14	19	27	24	45	27
PN 400	DDAS-16S	16	21	30	27	45	26.5
	DDAS-20S	20	26	36	32	51	29.5
	DDAS-25S	25	31	46	41	56	32
	DDAS-30S	30	36	50	46	62	35.5
PN 315	DDAS-38S	38	44	60	55	69	38

Dimensions given approximate length with tightened nut. All dimensions are in millimeters, for reference only subject to change.

DDASK

Welding Connector with DAK

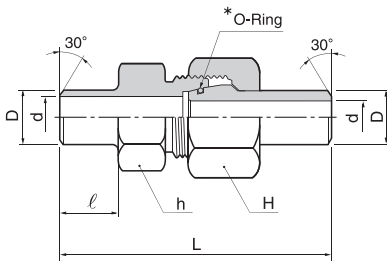

Series S Max. Pressure	Part No.	D (Tube O.D.)	d	H	h	L	l
PB 248	DDASK-10 x 1.0	10	8	22	19	58	10
PB 357	DDASK-10 x 1.5		7				
PB 458	DDASK-10 x 2.0		6				
PB 303	DDASK-12 x 1.5	12	9	24	22	65	15
PB 391	DDASK-12 x 2.0		8				
PB 474	DDASK-12 x 2.5		7				
PB 234	DDASK-16 x 1.5	16	13	30	27	74.5	16.5
PB 303	DDASK-16 x 2.0		12				
PB 370	DDASK-16 x 2.5		11				
PB 433	DDASK-16 x 3.0		10				
PB 249	DDASK-20 x 2.0	20	16	36	32	84	19
PB 305	DDASK-20 x 2.5		15				
PB 357	DDASK-20 x 3.0		14				
PB 458	DDASK-20 x 4.0		12				
PB 292	DDASK-25 x 3.0	25	19	46	41	94.5	19.5
PB 378	DDASK-25 x 4.0		17				
PB 458	DDASK-25 x 5.0		15				
PB 248	DDASK-30 x 3.0	30	24	50	46	102	23
PB 321	DDASK-30 x 4.0		22				
PB 391	DDASK-30 x 5.0		20				
PB 460	DDASK-30 x 6.0		18				
PB 260	DDASK-38 x 4.0	38	30	60	55	111	23
PB 318	DDASK-38 x 5.0		28				
PB 373	DDASK-38 x 6.0		26				
PB 427	DDASK-38 x 7.0		24				

Dimensions given approximate length with tightened nut. All dimensions are in millimeters, for reference only subject to change.
*O-ring of NBR Standard, of FPM(e.g. Viton®) on request.

DDAK

Welding Nipple with *O-Ring

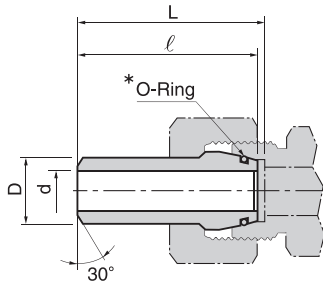

Fittings	Pressure Rating		Part No.	D (Tube O.D.)	d	L	l
	DDAK and Tube						
PN 630	PB 248	DDAK-10 x 1.0	10	8	35.5	33	
	PB 357	DDAK-10 x 1.5		7			
	PB 458	DDAK-10 x 2.0		6			
PN 630	PB 303	DDAK-12 x 1.5	12	9	35.5	33	
	PB 391	DDAK-12 x 2.0		8			
	PB 474	DDAK-12 x 2.5		7			
PN 400	PB 234	DDAK-16 x 1.5	16	13	42.5	39	
	PB 303	DDAK-16 x 2.0		12			
	PB 370	DDAK-16 x 2.5		11			
	PB 433	DDAK-16 x 3.0		10			
PN 400	PB 249	DDAK-20 x 2.0	20	16	47.5	43.5	
	PB 303	DDAK-20 x 2.5		15			
	PB 357	DDAK-20 x 3.0		14			
	PB 458	DDAK-20 x 4.0		12			
PN 400	PB 292	DDAK-25 x 3.0	25	19	55	49.5	
	PB 378	DDAK-25 x 4.0		17			
	PB 458	DDAK-25 x 5.0		15			
PN 400	PB 248	DDAK-30 x 3.0	30	24	58.5	51.5	
	PB 321	DDAK-30 x 4.0		22			
	PB 391	DDAK-30 x 5.0		20			
	PB 460	DDAK-30 x 6.0		18			
PN 315	PB 260	DDAK-38 x 4.0	38	30	66	56.5	
	PB 318	DDAK-38 x 5.0		28			
	PB 373	DDAK-38 x 6.0		26			
	PB 427	DDAK-38 x 7.0		24			

All dimensions are in millimeters, for reference only subject to change.
*O-ring of NBR Standard, of FPM(e.g Viton®) on request.

DDAKR

Reducing Welding Nipple with *O-Ring

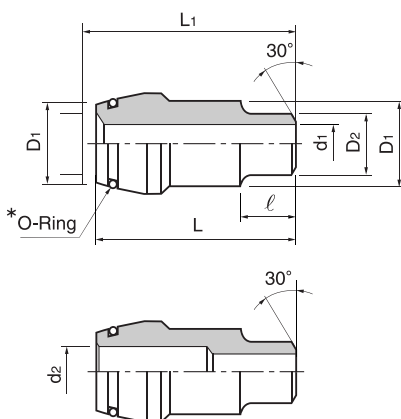

Fittings	Pressure Rating		Part No.	Tube O.D.		d1	d2	L1	L	l
	DDAKR and Tube			D1	D2					
PN 630	PB 526	DDAKR-1006 x 1.5	10	6	3	5	37.5	35	12	
	PB 526	DDAKR-1008 x 2.0	10	8	4	-	37.5	35	12	
	PB 526	DDAKR-1208 x 2.0	12	8	4	6	37.5	35	14	
	PB 357	DDAKR-1210 x 1.5	12	10	7	-	37.5	35	14	
PN 400	PB 474	DDAKR-1612 x 2.5	16	12	7	-	46.5	43	15	
	PB 474	DDAKR-2012 x 2.5	20	12	7	-	51.5	47.5	15	
	PB 433	DDAKR-2016 x 3.0	20	16	10	-	53.5	49.5	17	
	PB 433	DDAKR-2516 x 3.0	25	16	10	-	56.5	51	17	
	PB 458	DDAKR-2520 x 4.0	25	20	12	-	59.5	54	20	
	PB 303	DDAKR-3016 x 2.0	30	16	12	-	67	60	17	
	PB 303	DDAKR-3020 x 2.5	30	20	15	-	70	63	20	
	PB 292	DDAKR-3025 x 3.0	30	25	19	-	70	63	20	
PN 315	PB 303	DDAKR-3816 x 2.0	38	16	12	-	79	69.5	17	
	PB 303	DDAKR-3820 x 2.5	38	20	15	-	82	72.5	20	
	PB 292	DDAKR-3825 x 3.0	38	25	19	-	82	72.5	20	
	PB 321	DDAKR-3830 x 4.0	38	30	22	-	82	72.5	20	

All dimensions are in millimeters, for reference only subject to change.
*O-ring of NBR Standard, of FPM(e.g Viton®) on request.

Installation Instruction for Welding Nipple Fittings

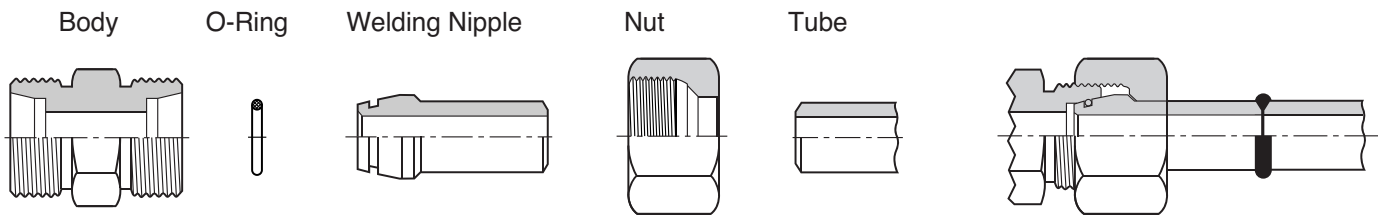

- Step1. Pipe to be cut at right angle by sawing and freed from burrs both inside and outside.
- Step2. Slide nut onto the weld nipple.
- Step3. Welding nipple and tube to be welded together and weld to be cleaned between runs.
The tube and welding nipple must be aligned.
- Step4. Fit the O-Ring: Attention, do not twist O-Ring: taper, nut and cone must be clean.
- Step5. Thread on body and nut to be oiled.
- Step6. Screw on nut by hand. Fully tighten using a spanner with a 1/3 turn.

Ordering information for Welding Nipple Fittings

Order No.	Figures	Order No.	Figures
DDGV	DDU (Without Cutting Ring)+DDAK	DDGEV	DDMC (Without Cutting Ring)+DDAK
DDWV	DDL (Without Cutting Ring)+DDAK	DDGUV	DDMC-ED (Without Cutting Ring)+DDAK
DDTV	DDT (Without Cutting Ring)+DDAK	DDGEV-R	DDMC (Without Cutting Ring)+DDAK
DDWSEV	DDSWVE (Without Cutting Ring)+DDAK	DDGAI	DDFC (Without Cutting Ring)+DDAK
		DDWEV	DDL (Without Cutting Ring)+DDAK

DMFAD

Male Female Adaptor
(BSP Parallel)

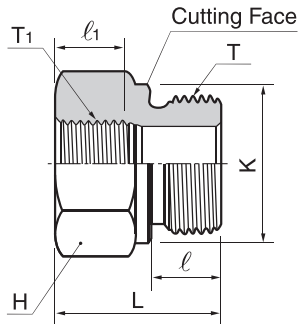

From B stud end

Series	Part No.	H	K	L	l	l ₁	Male stud T G(PF)	Female stud T ₁ G(PF)
PB 630	DMFAD-03-01G	22	22	22.5	12	8	3/8	1/8
PB 630	DMFAD-04-01G	27	26	24	14	8	1/2	1/8
PB 400	DMFAD-04-02G	27	26	24	14	12	1/2	1/4
PB 400	DMFAD-06-02G	32	32	26	16	12	3/4	1/4
	DMFAD-06-03G	32	32	26	16	12	3/4	3/8
PB 400	DMFAD-08-02G	41	39	29	18	12	1	1/4
	DMFAD-08-03G	41	39	29	18	12	1	3/8
	DMFAD-08-04G	41	39	29	18	14	1	1/2
PB 250	DMFAD-10-04G	50	49	32	20	14	1-1/4	1/2
	DMFAD-10-06G	50	49	32	20	16	1-1/4	3/4
PB 250	DMFAD-12-04G	55	55	36	22	14	1-1/2	1/2
	DMFAD-12-06G	55	55	36	22	16	1-1/2	3/4
	DMFAD-12-08G	55	55	36	22	18	1-1/2	1

Male/ Female thread adaptors with metric and NPT thread on request. All dimensions are in millimeters, for reference only subject to change.

DMFAE

Male Female Adaptor
(BSP Parallel)

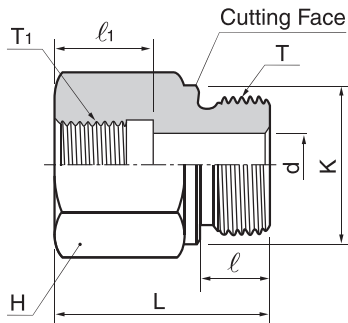

From B stud end

Series	Part No.	d	H	K	L	l	l ₁	Male stud T G(PF)	Female stud T ₁ G(PF)
PB 630	DMFAE-01-02G	4	19	14	31	8	17	1/8	1/4
	DMFAE-01-03G	4	24	14	32	8	17	1/8	3/8
PB 630	DMFAE-02-01G	5	19	18	28	12	12	1/4	1/8
	DMFAE-02-03G	5	24	18	36	12	17	1/4	3/8
	DMFAE-02-04G	5	30	18	40	12	20	1/4	1/2
PB 400	DMFAE-02-06G	5	36	18	43	12	22	1/4	3/4
PB 630	DMFAE-03-02G	8	22	22	36	12	17	3/8	1/4
	DMFAE-03-04G	8	30	22	41	12	20	3/8	1/2
PB 250	DMFAE-03-06G	8	36	22	44	12	22	3/8	3/4
PB 400	DMFAE-04-03G	12	27	26	36	14	17	1/2	3/8
	DMFAE-04-06G	12	36	26	46	14	22	1/2	3/4
	DMFAE-04-08G	12	41	26	49	14	24.5	1/2	1
PB 250	DMFAE-04-10G	10	55	26	53	14	26.5	1/2	1-1/4
PB 400	DMFAE-06-04G	16	32	32	41	16	20	3/4	1/2
	DMFAE-06-08G	16	41	32	51	16	24.5	3/4	1
	DMFAE-06-10G	16	55	32	55	16	26.5	3/4	1-1/4
PB 250	DMFAE-06-12G	16	60	32	57	16	28.5	3/4	1-1/2
PB 400	DMFAE-08-06G	20	41	39	47	18	22	1	3/4
PB 250	DMFAE-08-10G	20	55	39	57	18	26.5	1	1-1/4
	DMFAE-08-12G	20	60	39	59	18	28.5	1	1-1/2
PB 250	DMFAE-10-08G	25	50	49	52	20	24.5	1-1/4	1
	DMFAE-10-12G	25	60	49	60	20	28.5	1-1/4	1-1/2
PB 250	DMFAE-12-10G	32	55	55	58	22	26.5	1-1/2	1-1/4
PB 250	DMFAE-16-12G	40	70	68	62	24	28.5	2	1-1/2

Male/ Female thread adaptors with metric and NPT thread on request. All dimensions are in millimeters, for reference only subject to change.

DMFAD-ED

Male Female Adaptor
(BSP Parallel)
with *ED-Ring

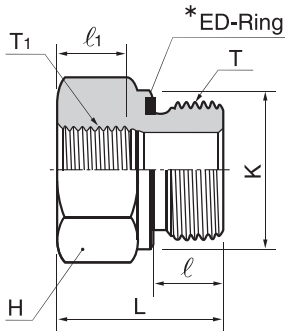

From E stud end

Series	Part No.	H	K	L	l	l ₁	Male stud T G(PF)	Female stud T ₁ G(PF)
PB 630	DMFAD-03ED-01G	22	22	22.5	12	8	3/8	1/8
PB 630	DMFAD-04ED-01G	27	26	24	14	8	1/2	1/8
PB 400	DMFAD-04ED-02G	27	26	24	14	12	1/2	1/4
PB 400	DMFAD-06ED-02G	32	32	26	16	12	3/4	1/4
	DMFAD-06ED-03G	32	32	26	16	12	3/4	3/8
PB 400	DMFAD-08ED-02G	41	39	29	18	12	1	1/4
	DMFAD-08ED-03G	41	39	29	18	12	1	3/8
	DMFAD-08ED-04G	41	39	29	18	14	1	1/2
PB 250	DMFAD-10ED-04G	50	49	32	20	14	1-1/4	1/2
	DMFAD-10ED-06G	50	49	32	20	16	1-1/4	3/4
PB 250	DMFAD-12ED-04G	55	55	36	22	14	1-1/2	1/2
	DMFAD-12ED-06G	55	55	36	22	16	1-1/2	3/4
	DMFAD-12ED-08G	55	55	36	22	18	1-1/2	1

All dimensions are in millimeters, for reference only subject to change.
*ED-ring of NBR Standard, of FPM(e.g Viton) on request.

DMFAE-ED

Male Female Adaptor
(BSP Parallel)
with *ED-Ring

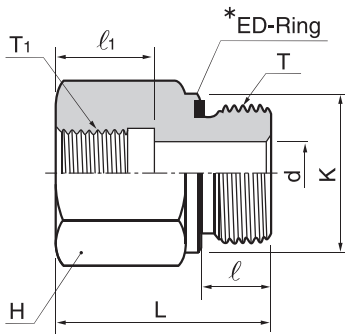

From E stud end

Series	Part No.	D	H	K	L	l	l ₁	Male stud T G(PF)	Female stud T ₁ G(PF)
PB 630	DMFAE-01ED-02G	4	19	14	31	8	17	1/8	1/4
	DMFAE-01ED-03G	4	24	14	32	8	17	1/8	3/8
PB 630	DMFAE-02ED-01G	5	19	18	28	12	12	1/4	1/8
	DMFAE-02ED-03G	5	24	18	36	12	17	1/4	3/8
	DMFAE-02ED-04G	5	30	18	40	12	20	1/4	1/2
PB 450	DMFAE-02ED-06G	5	36	18	43	12	22	1/4	3/4
PB 630	DMFAE-03ED-02G	8	22	22	36	12	17	3/8	1/4
	DMFAE-03ED-04G	8	30	22	41	12	20	3/8	1/2
PB 400	DMFAE-03ED-06G	8	36	22	44	12	22	3/8	3/4
PB 400	DMFAE-04ED-03G	12	27	26	36	14	17	1/2	3/8
	DMFAE-04ED-06G	12	36	26	46	14	22	1/2	3/4
	DMFAE-04ED-08G	12	41	26	49	14	24.5	1/2	1
PB 250	DMFAE-04ED-10G	10	55	26	53	14	26.5	1/2	1-1/4
PB 400	DMFAE-06ED-04G	16	32	32	41	16	20	3/4	1/2
	DMFAE-06ED-08G	16	41	32	51	16	24.5	3/4	1
	DMFAE-06ED-10G	16	55	32	55	16	26.5	3/4	1-1/4
PB 250	DMFAE-06ED-12G	16	60	32	57	16	28.5	3/4	1-1/2
PB 400	DMFAE-08ED-06G	20	41	39	47	18	22	1	3/4
PB 250	DMFAE-08ED-10G	20	55	39	57	18	26.5	1	1-1/4
	DMFAE-08ED-12G	20	60	39	59	18	28.5	1	1-1/2
PB 250	DMFAE-10ED-08G	25	50	49	52	20	24.5	1-1/4	1
	DMFAE-10ED-12G	25	60	49	60	20	28.5	1-1/4	1-1/2
PB 250	DMFAE-12ED-10G	32	55	55	58	22	26.5	1-1/2	1-1/4
PB 250	DMFAE-16ED-12G	40	70	68	62	24	28.5	2	1-1/2

All dimensions are in millimeters, for reference only subject to change.
*ED-ring of NBR Standard, of FPM(e.g Viton) on request.

DDVSTI-GED/MED

Blanking Plugs for Port with *ED-Ring

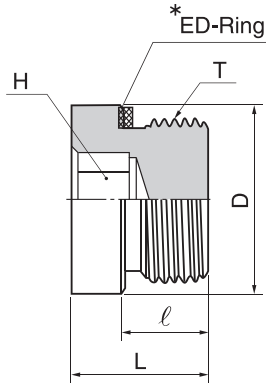

Series	Part No.(M)	Part No.(G)	T M(Metric)	T G(PF)	D	H	L	ℓ
PB 400	DDVSTI-M10ED	SDVSTI-01GED	M10 x 1	1/8	14	5	12	8
	DDVSTI-M12ED	-	M12 x 1.5	-	17	6	17	12
	DDVSTI-M14ED	SDVSTI-02GED	M14 x 1.5	1/4	19	6	17	12
	DDVSTI-M16ED	SDVSTI-03GED	M16 x 1.5	3/8	22	8	17	12
	DDVSTI-M18ED	-	M18 x 1.5	-	23.9	8	17	12
	DDVSTI-M20ED	-	M20 x 1.5	-	25.9	10	19	14
	DDVSTI-M22ED	SDVSTI-04GED	M22 x 1.5	1/2	27	10	19	14
	DDVSTI-M26ED	-	M26 x 1.5	-	31.9	12	21	16
	DDVSTI-M27ED	SDVSTI-06GED	M27 x 2	3/4	32	12	21	16
	DDVSTI-M33ED	SDVSTI-08GED	M33 x 2	1	39.9	17	22.5	16
PB 250	DDVSTI-M42ED	SDVSTI-10GED	M42 x 2	1-1/4	49.9	22	22.5	16
	DDVSTI-M48ED	SDVSTI-12GED	M48 x 2	1-1/2	55	24	22.5	16

All dimensions are in millimeters, for reference only subject to change.
 *ED-ring of NBR Standard, of FPM(e.g Viton) on request.

DDVSTI

Blanking Plugs with *O-Ring (accord.to ISO 6149-3/DIN 3582)

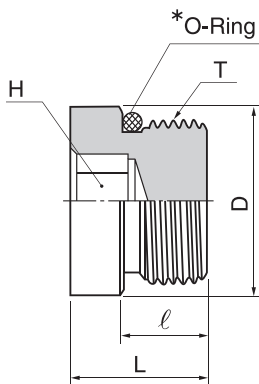

Series	Part No.	T M(Metric)	D	H	L	ℓ
PB 630	DDVSTI-M10	M10 x 1	13	5	14	10
	DDVSTI-M12	M12 x 1.5	17	6	16.5	11.5
	DDVSTI-M14	M14 x 1.5	19	6	16.5	11.5
	DDVSTI-M16	M16 x 1.5	21	6	18	13
	DDVSTI-M18	M18 x 1.5	23	8	19.5	14.5
PB 400	DDVSTI-M22	M22 x 1.5	27	10	20.5	15.5
	DDVSTI-M26	M26 x 1.5	31	12	21	16
	DDVSTI-M27	M27 x 2	32	12	24	19
	DDVSTI-M33	M33 x 2	38	17	25.5	19
	DDVSTI-M42	M42 x 2	48	22	26	19.5

All dimensions are in millimeters, for reference only subject to change.
 *O-ring of NBR Standard, of FPM(e.g Viton®) on request.

DDVKA

Blanking Plug with *O-Ring

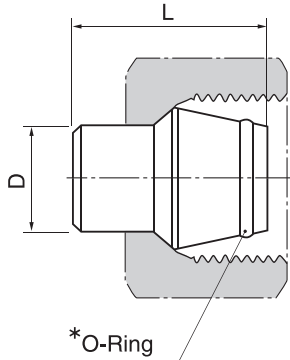

Series	Part No.	D (Tube O.D.)	L
L Light PN 315 /PN 630	DDVKA-06L/S	6	18.5
	DDVKA-08L/S	8	18.5
	DDVKA-10L/S	10	20
	DDVKA-12L/S	12	20.5
	DDVKA-15L	15	20.5
	DDVKA-18L	18	22.5
PN 160	DDVKA-22L	22	25
	DDVKA-28L	28	25.5
	DDVKA-35L	35	30
	DDVKA-42L	42	30
S Heavy PN 630	DDVKA-14S	14	22.5
	-	-	-
PN 400	DDVKA-16S	16	23.5
	DDVKA-20S	20	28.5
	DDVKA-25S	25	29
	DDVKA-30S	30	30.5
PN 315	DDVKA-38S	38	33

Dimensions given approximate length with tightened nut. All dimensions are in millimeters, for reference only subject to change.

DDCA

Tube Cap

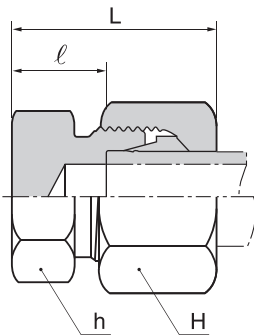

Series	Part No.	Tube O.D.	H	h	L	l
L Light PN 315	DDCA-06L	6	14	12	22	7
	DDCA-08L	8	17	14	23	8
	DDCA-10L	10	19	17	24	9
	DDCA-12L	12	22	19	25	10
	DDCA-15L	15	27	24	26	11
	DDCA-18L	18	32	27	28	11.5
PN 160	DDCA-22L	22	36	32	30	13.5
	DDCA-28L	28	41	41	31	14.5
	DDCA-35L	35	50	46	36	14.5
	DDCA-42L	42	60	55	39	16
S Heavy PN 630	DDCA-06S	6	17	14	26	11
	DDCA-08S	8	19	17	28	13
	DDCA-10S	10	22	19	29	12.5
	DDCA-12S	12	24	22	31	14.5
	DDCA-14S	14	27	24	34	16
PN 400	DDCA-16S	16	30	27	34	15.5
	DDCA-20S	20	36	32	39	17.5
	DDCA-25S	25	46	41	44	20
	DDCA-30S	30	50	46	47	20.5
PN 315	DDCA-38S	38	60	55	54	23

Dimensions given approximate length with tightened nut. All dimensions are in millimeters, for reference only subject to change.

DDN

Nut

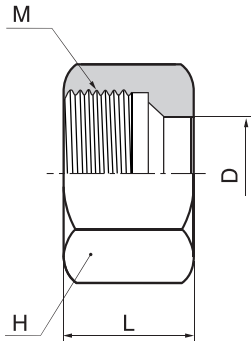
**DDS**

Cutting Ring

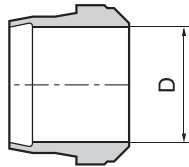

Tube end Dimension

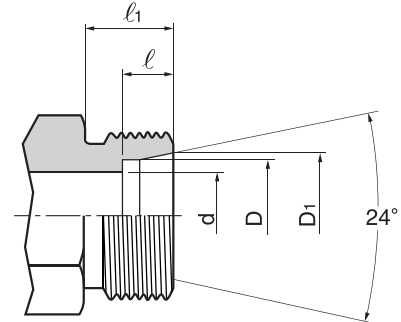

Series	Part No. Nut	Part No. Cutting Ring	Tube O.D.	DN Size	D	D ₁	d	H	L	M	l	l ₁
LL Very Light	DDN-04LL	DDS-04LL	4	3	4	5	3	10	11.5	M8 x 1.0	4	8
	DDN-06LL	DDS-06LL	6	4	6	7.5	4.5	12	12	M10 x 1.0	5.5	8
	DDN-08LL	DDS-08LL	8	6	8	9.5	6	14	12.5	M12 x 1.0	5.5	9
	DDN-10LL	DDS-10LL	10	8	10	11.5	8	17	12.5	M14 x 1.0	6	9
	DDN-12LL	DDS-12LL	12	10	12	13.5	10	19	13	M16 x 1.0	6	9
L Light	DDN-06L	DDS-06	6	4	6	8.1	4	14	15	M12 x 1.5	7	10
	DDN-08L	DDS-08	8	6	8	10.1	6	17	15	M14 x 1.5	7	10
	DDN-10L	DDS-10	10	8	10	12.3	8	19	16	M16 x 1.5	7	11
	DDN-12L	DDS-12	12	10	12	14.3	10	22	16	M18 x 1.5	7	11
	DDN-15L	DDS-15	15	12	15	17.3	12	27	17.5	M22 x 1.5	7	12
	DDN-18L	DDS-18	18	16	18	20.3	15	32	18	M26 x 1.5	7.5	12
	DDN-22L	DDS-22	22	20	22	24.3	19	36	20.5	M30 x 2	7.5	14
	DDN-28L	DDS-28	28	25	28	30.3	24	41	21	M36 x 2	7.5	14
	DDN-35L	DDS-35	35	32	35	38	30	50	24	M45 x 2	10.5	16
DDN-42L	DDS-42	42	40	42	45	36	60	24	M52 x 2	11	16	
S Heavy	DDN-06S	DDS-06	6	3	6	8.1	4	17	16.5	M14 x 1.5	7	12
	DDN-08S	DDS-08	8	4	8	10.1	5	19	16.5	M16 x 1.5	7	12
	DDN-10S	DDS-10	10	6	10	12.3	7	22	17.5	M18 x 1.5	7.5	12
	DDN-12S	DDS-12	12	8	12	14.3	8	24	18	M20 x 1.5	7.5	12
	DDN-14S	DDS-14	14	10	14	16.3	10	27	20.5	M22 x 1.5	8	14
	DDN-16S	DDS-16	16	12	16	18.3	12	30	21	M24 x 1.5	8.5	14
	DDN-20S	DDS-20	20	16	20	22.9	16	36	24	M30 x 2	10.5	16
	DDN-25S	DDS-25	25	20	25	27.9	20	46	27	M36 x 2	12	18
	DDN-30S	DDS-30	30	25	30	33	25	50	29.5	M42 x 2	13.5	20
DDN-38S	DDS-38	38	32	38	41	32	60	32.5	M52 x 2	16	22	

All dimensions are in millimeters, for reference only subject to change.

TUBE FITTINGS FOR DIN 2353



J | lansun



27 Noksansandan361-ro, Gangseo-gu
(Songjeong-dong), Busan, Korea

Tel : +82-51-899-6700, Fax : +82-51-899-6799

E-Mail : overseas@ehansun.co.kr

sales@ehansun.co.kr

Website : www.ehansun.co.kr, www.slok.co.kr