

Swivels

General Introduction

Applications

Some common markets and applications for swivels are:

- Injection Molding
- Pulp and Paper
- Logging
- Refuse Trucks
- Utility Equipment
- Mobile Equipment
- Flight Simulators
- Car Washes
- Hose Reels
- Pressure Washers
- Machine Tools
- Steel Mills
- Palletizers
- And many more...

Table of Contents

Swivels

ApplicationsD-1

PS Series

Introduction	D-4
How To Order	D-5
In-Line	D-6
90°	D-12
Repair Kits	D-21
Seal Options	D-21

S Series

Introduction	D-22
How To Order	D-23
90°	D-24
Repair Kits	D-28
Seal Options	D-28

Introduction

The design and manufacturing processes vital to a swivel's quality are the cornerstone of the Quick Coupling Division's day to day operations. The PS Series Swivel is designed to meet the application needs and performance requirements of the market. Pressure capabilities up to 5000 psi, 1/4" through 2" body sizes, a variety of port options, Chromium-6 Free or nickel plating and a wide range of seal options make the PS Series Swivels ideal for an array of dynamic applications.



Features

- Hardened bearing races for extended service life.
- Full flow design minimizes pressure drop for optimum system performance.
- Sealed bearing design isolates bearing race from media and environment.
- Reduced bearing load design minimizes wear in the bearing race and extends service life.
- PTFE back-up rings support primary seal for high-pressure applications.
- Chromium-6 Free plating for maximum corrosion resistance.
- Variety of seal options available.
- Three piece swivel design for sizes 1 1/4" through 2" for superior performance and service life.
- Precision needle bearings and ball bearings sized 1 1/4" through 2" for additional side load resistance.
- Polyurethane U-Cup primary seal standard for sizes 1 1/4" through 2".
- PS Series Swivels eliminate hose twist and torque that may cause premature hose failure.

Specifications

Body Size (in.)	1/4	3/8	1/2	3/4	1	1-1/4	1-1/2	2
Maximum Rated Pressure (PSI)	5000	5000	5000	5000	5000	4000	4000	3000
<i>Except the following port options in the noted size</i>								
03 (Male JIC 37°)							3000	2000
05 (Male SAE O-Ring Boss)								2500
06 (Female JIC 37°) 90° Housing Port				4000	3000	3000	2500	2000
06 (Female JIC 37°) In-Line Housing Port							3000	2000
07 (Female NPSM)			4600	3000	2600	2100	1650	1500
Temperature Range (std seals)				-40° to 250° F			-30° to 180° F	

Performance Data

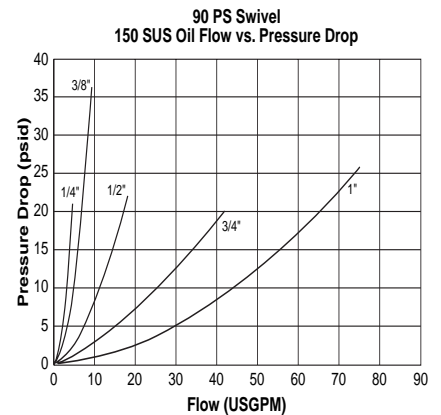
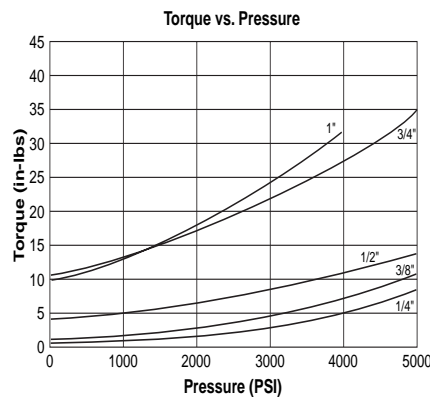
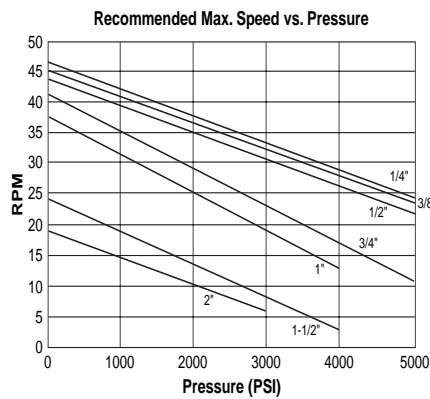

In-Line Swivels

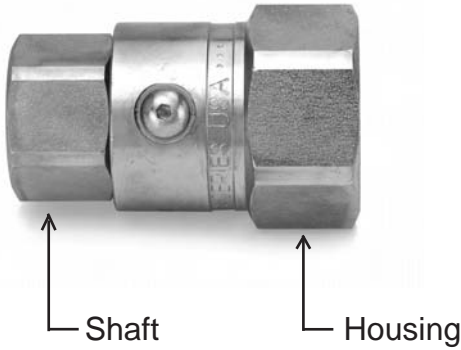

90° Swivels

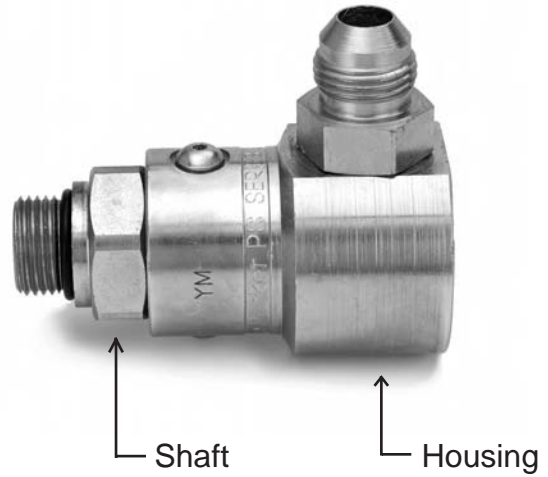

PS Part Number:

PS 16 1 02 02-16-16 Y-

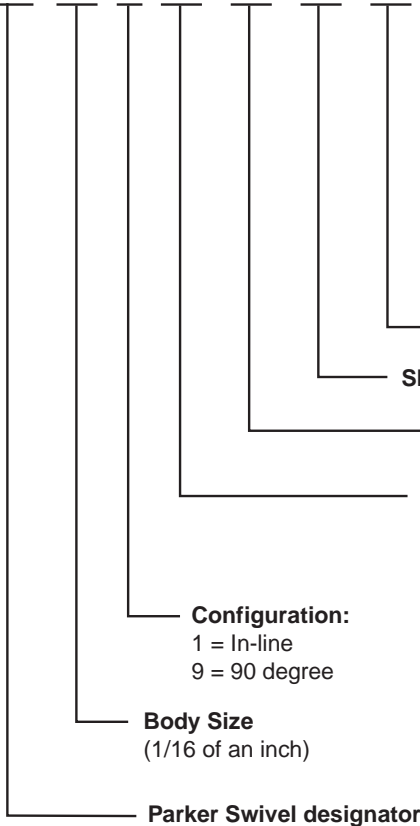

Material and Finish:
Blank = Carbon Steel
w/Chromium-6 Free Plating (Std.)
NI = Carbon Steel with Electroless Nickel Plating*
S3 = 303 Stainless Steel Passivated*
S6 = 316 Stainless Steel Electropolished*

Housing Port Size (1/16 of an inch)††

Shaft Port Size (1/16 of an inch)††

*Contact Division for price and delivery
† On -24 and -32 sizes, Polyurethane U-Cup Seal is standard.
†† For -20 Ports, -24 Body is used.

D Swivels

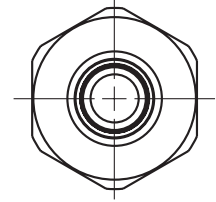
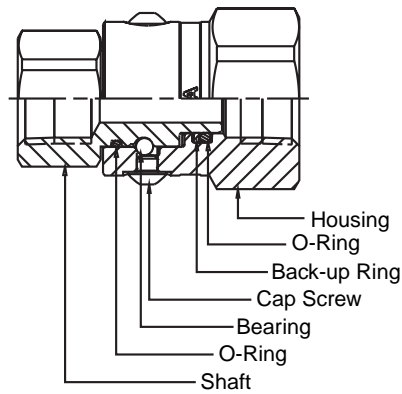

Materials Of Construction

- Housing*:.....Carbon Steel
- Shaft*:.....Carbon Steel
- Plating*:.....Chromium-6 Free
- Bearing*:.....Chrome
- O-Rings*:.....Nitrile
- Back-Up Ring:.....PTFE

* See How-To-Order for optional material, plating, and seals.

Male Pipe - Female Pipe

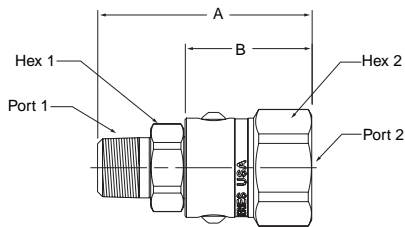

Part Number	A	B	Hex 1	Hex 2	Port 1	Port 2
PS410102-4-4	2.59" 65.8 mm	1.60" 40.6 mm	.75" 19.0 mm	1.19" 30.2 mm	1/4-18 NPTF	1/4-18 NPTF
PS610102-6-6	2.66" 67.5 mm	1.64" 41.7 mm	.88" 22.2 mm	1.31" 33.3 mm	3/8-18 NPTF	3/8-18 NPTF
PS810102-8-8	3.03" 76.8 mm	1.79" 45.5 mm	1.12" 28.6 mm	1.50" 36.5 mm	1/2-14 NPTF	1/2-14 NPTF
PS1210102-12-12	3.10" 78.8 mm	1.85" 47.0 mm	1.38" 35.0 mm	1.69" 42.9 mm	3/4-14 NPTF	3/4-14 NPTF
PS1610102-16-16	3.54" 89.8 mm	2.11" 53.5 mm	1.62" 41.3 mm	1.88" 47.6 mm	1-11 1/2 NPTF	1-11 1/2 NPTF

Male Pipe - Male 37° Flare

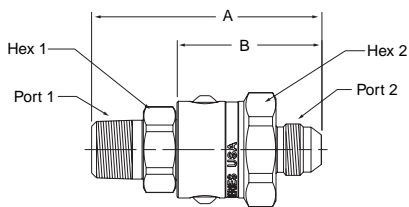

Part Number	A	B	Hex 1	Hex 2	Port 1	Port 2
PS410103-4-4	2.86" 72.6 mm	1.87" 47.5 mm	.75" 19.0 mm	1.19" 30.2 mm	1/4-18 NPTF	7/16-20 UNF
PS610103-6-6	2.92" 74.1 mm	1.90" 48.3 mm	.88" 22.2	1.31" 33.3 mm	3/8-18 NPTF	9/16-18 UNF
PS810103-8-8	3.33" 84.5 mm	2.09" 53.1 mm	1.12" 28.6 mm	1.50" 36.5 mm	1/2-14 NPTF	3/4-16 UNF
PS1210103-12-12	3.55" 90.3 mm	2.30" 58.4 mm	1.38" 35.0 mm	1.69" 42.9 mm	3/4-14 NPTF	1-1/16-12 UN
PS1610103-16-16	3.88" 98.6 mm	2.45" 62.2 mm	1.62" 41.3 mm	1.88" 47.6 mm	1-11 1/2 NPTF	1-5/16-12 UN

Male Pipe - Female 37° Flare

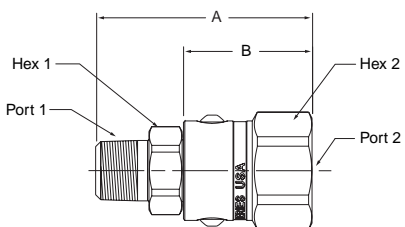

Part Number	A	B	Hex 1	Hex 2	Port 1	Port 2
PS410106-4-4	2.72" 69.1 mm	1.73" 43.9 mm	.75" 19.0 mm	1.19" 30.2 mm	1/4-18 NPTF	7/16-20 UNF
PS610106-6-6	2.77" 70.3 mm	1.75" 44.5 mm	.88" 22.2 mm	1.31" 33.3 mm	3/8-18 NPTF	9/16-18 UNF
PS810106-8-8	3.05" 77.3 mm	1.81" 46.0 mm	1.12" 28.6 mm	1.50" 36.5 mm	1/2-14 NPTF	3/4-16 UNF
PS1210106-12-12	3.27" 83.2 mm	2.02" 51.3 mm	1.38" 35.0 mm	1.69" 42.9 mm	3/4-14 NPTF	1-1/16-12 UN
PS1610106-16-16	3.62" 92.0 mm	2.19" 55.6 mm	1.62" 41.3 mm	1.88" 47.6 mm	1-11 1/2 NPTF	1-5/16-12 UN

Male Pipe - Female SAE Straight Thread

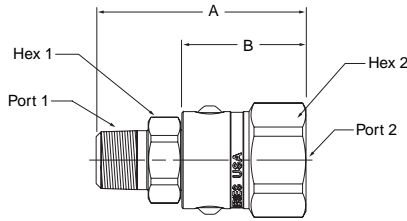

Part Number	A	B	Hex 1	Hex 2	Port 1	Port 2
PS410110-4-4	2.71" 68.8 mm	1.72" 43.7 mm	.75" 19.0 mm	1.19" 30.2 mm	1/4-18 NPTF	7/16-20 UNF
PS610110-6-6	2.74" 69.6 mm	1.72" 43.7 mm	.88" 22.2 mm	1.31" 33.3 mm	3/8-18 NPTF	9/16-18 UNF
PS810110-8-8	3.03" 76.8 mm	1.79" 45.5 mm	1.12" 28.6 mm	1.50" 36.5 mm	1/2-14 NPTF	3/4-16 UNF
PS1210110-12-12	3.33" 84.7 mm	2.08" 52.8 mm	1.38" 35.0 mm	1.69" 42.9 mm	3/4-14 NPTF	1-1/16-12 UN
PS1610110-16-16	3.63" 92.2 mm	2.20" 55.9 mm	1.62" 41.3 mm	1.88" 47.6 mm	1-11 1/2 NPTF	1-5/16-20 UN

Female Pipe - Female Pipe

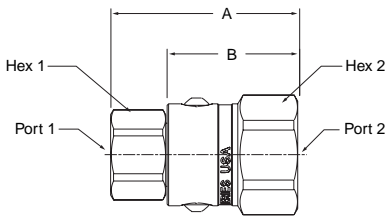

Part Number	A	B	Hex 1	Hex 2	Port 1	Port 2
PS410202-4-4	2.16" 54.9 mm	1.60" 40.6 mm	.75" 19.0 mm	1.19" 30.2 mm	1/4-18 NPTF	1/4-18 NPTF
PS610202-6-6	2.30" 58.3 mm	1.64" 41.7 mm	.88" 22.2 mm	1.31" 33.3 mm	3/8-18 NPTF	3/8-18 NPTF
PS810202-8-8	2.56" 65.0 mm	1.79" 45.5 mm	1.12" 28.6 mm	1.50" 36.5 mm	1/2-14 NPTF	1/2-14 NPTF
PS1210202-12-12	2.88" 73.1 mm	1.85" 47.0 mm	1.38" 35.0 mm	1.69" 42.9 mm	3/4-14 NPTF	3/4-14 NPTF
PS1610202-16-16	3.16" 80.1 mm	2.11" 53.5 mm	1.62" 41.3 mm	1.88" 47.6 mm	1-11 1/2 NPTF	1-11 1/2 NPTF

3 Piece Design

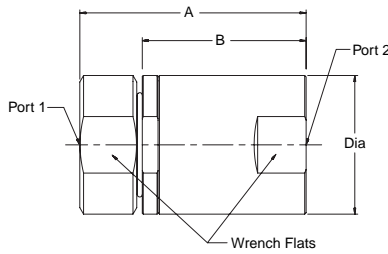

Part Number	A	B	Wrench Flats	Dia.	Port 1	Port 2
PS2410202-20-20	4.67" 118.6 mm	3.38" 85.9 mm	2.63" 66.7 mm	2.88" 73.0 mm	1 1/4-11 1/2 NPTF	1 1/4-11 1/2 NPTF
PS2410202-24-24	4.67" 118.6 mm	3.38" 85.9 mm	2.63" 66.7 mm	2.88" 73.0 mm	1 1/2-11 1/2 NPTF	1 1/2-11 1/2 NPTF
PS3210202-32-32	4.88" 123.9 mm	3.58" 90.8 mm	3.06" 77.6 mm	3.35" 85.1 mm	2-11 1/2 NPTF	2-11 1/2 NPTF

Female Pipe - Male 37° Flare

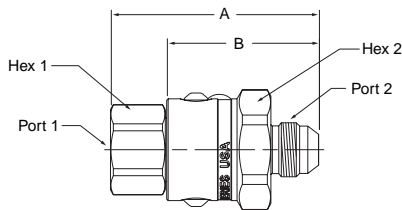

Part Number	A	B	Hex 1	Hex 2	Port 1	Port 2
PS410203-4-4	2.43" 61.7 mm	1.87" 47.5 mm	.75" 19.0 mm	1.19" 30.2 mm	1/4-18 NPTF	7/16-20 UNF
PS610203-6-6	2.56" 65.0 mm	1.90" 48.3 mm	.88" 22.2 mm	1.31" 33.3 mm	3/8-18 NPTF	9/16-18 UNF
PS810203-8-8	2.86" 72.7 mm	2.09" 53.1 mm	1.12" 28.6 mm	1.50" 36.5 mm	1/2-14 NPTF	3/4-16 UNF
PS1210203-12-12	3.33" 84.5 mm	2.30" 58.4 mm	1.38" 35.0 mm	1.69" 42.9 mm	3/4-14 NPTF	1-1/16-12 UN
PS1610203-16-16	3.50" 88.9 mm	2.45" 62.2 mm	1.62" 41.3 mm	1.88" 47.6 mm	1-11 1/2 NPTF	1-5/16-12 UN

3 Piece Design

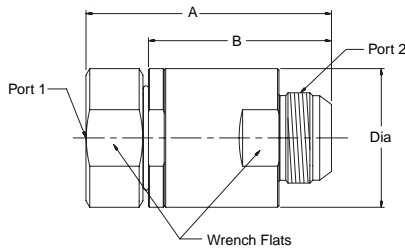

Part Number	A	B	Wrench Flats	Dia.	Port 1	Port 2
PS2410203-20-20	5.06" 128.6 mm	3.78" 95.9 mm	2.63" 66.7 mm	2.88" 73.0 mm	1 1/4-11 1/2 NPTF	1 5/8-12 UN
PS2410203-24-24	5.06" 128.6 mm	3.78" 95.9 mm	2.63" 66.7 mm	2.88" 73.0 mm	1 1/2-11 1/2 NPTF	1 7/8-12 UN
PS3210203-32-32	5.58" 141.7 mm	4.28" 108.6 mm	3.06" 77.6 mm	3.35" 85.1 mm	2-11 1/2 NPTF	2 1/2-12 UN

Female Pipe - Female 37° Flare

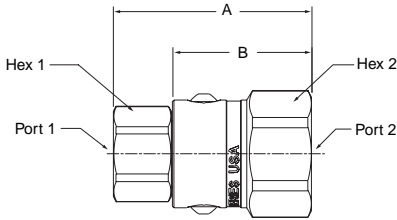

Part Number	A	B	Hex 1	Hex 2	Port 1	Port 2
PS410206-4-4	2.29" 58.2 mm	1.73" 43.9 mm	.75" 19.0 mm	1.19" 30.2 mm	1/4-18 NPTF	7/16-20 UNF
PS610206-6-6	2.41" 61.1 mm	1.75" 44.5 mm	.88" 22.2 mm	1.31" 33.3 mm	3/8-18 NPTF	9/16-18 UNF
PS810206-8-8	2.58" 65.6 mm	1.81" 46.0 mm	1.12" 28.6 mm	1.50" 36.5 mm	1/2-14 NPTF	3/4-16 UNF
PS1210206-12-12	3.05" 77.4 mm	2.02" 51.3 mm	1.38" 35.0 mm	1.69" 42.9 mm	3/4-14 NPTF	1-1/16-12 UN
PS1610206-16-16	3.24" 82.3 mm	2.19" 55.6 mm	1.62" 41.3 mm	1.88" 47.6 mm	1-11/2 NPTF	1-5/16-12 UN

Female Pipe - Female SAE Straight Thread

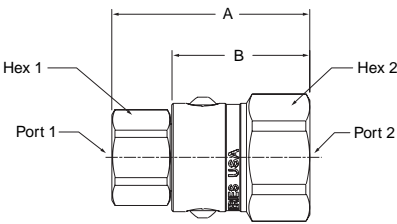

Part Number	A	B	Hex 1	Hex 2	Port 1	Port 2
PS410210-4-4	2.28" 57.9 mm	1.72" 43.7 mm	.75" 19.0 mm	1.19" 30.2 mm	1/4-18 NPTF	7/16-20 UNF
PS610210-6-6	2.38" 60.4 mm	1.72" 43.7 mm	.88" 22.2 mm	1.31" 33.3 mm	3/8-18 NPTF	9/16-18 UNF
PS810210-8-8	2.56" 65.0 mm	1.79" 45.5 mm	1.12" 28.6 mm	1.50" 36.5 mm	1/2-14 NPTF	3/4-16 UNF
PS1210210-12-12	3.11" 78.9 mm	2.08" 52.8 mm	1.38" 35.0 mm	1.69" 42.9 mm	3/4-14 NPTF	1-1/16-12 UN
PS1610210-16-16	3.25" 82.6 mm	2.20" 55.9 mm	1.62" 41.3 mm	1.88" 47.6 mm	1-11/2 NPTF	1-5/16-20 UN

Male 37° Flare - Female Pipe

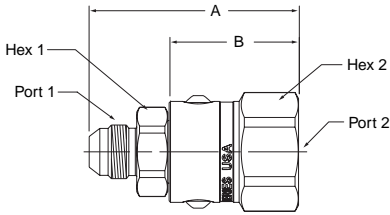

Part Number	A	B	Hex 1	Hex 2	Port 1	Port 2
PS410302-4-4	2.59" 65.8 mm	1.60" 40.6 mm	.75" 19.0 mm	1.19" 30.2 mm	7/16-20 UNF	1/4-18 NPTF
PS610302-6-6	2.66" 67.5 mm	1.64" 41.7 mm	.88" 22.2 mm	1.31" 33.3 mm	9/16-18 UNF	3/8-18 NPTF
PS810302-8-8	2.89" 73.5 mm	1.79" 45.5 mm	1.12" 28.6 mm	1.50" 36.5 mm	3/4-16 UNF	1/2-14 NPTF
PS1210302-12-12	3.21" 81.5 mm	1.85" 47.0 mm	1.38" 35.0 mm	1.69" 42.9 mm	1-1/16-12 UN	3/4-14 NPTF
PS1610302-16-16	3.54" 89.8 mm	2.11" 53.5 mm	1.62" 41.3 mm	1.88" 47.6 mm	1-5/16-12 UN	1-11/2 NPTF

3 Piece Design

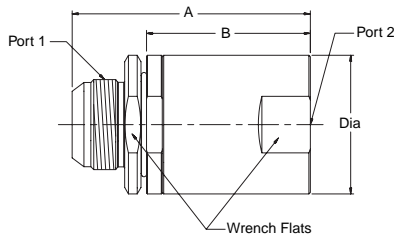

Part Number	A	B	Wrench Flats	Dia.	Port 1	Port 2
PS2410302-20-20	4.91" 124.8 mm	3.38" 85.9 mm	2.63" 66.7 mm	2.88" 73.0 mm	1 5/8-12 UN	1 1/4-11 1/2 NPTF
PS2410302-24-24	4.91" 124.8 mm	3.38" 85.9 mm	2.63" 66.7 mm	2.88" 73.0 mm	1 7/8-12 UN	1 1/2-11 1/2 NPTF
PS3210302-32-32	5.50" 139.8 mm	3.58" 90.8 mm	3.06" 77.6 mm	3.35" 85.1 mm	2 1/2-12 UN	2-11 1/2 NPTF

Male 37° Flare - Male 37° Flare

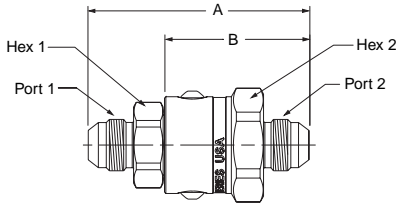

3 Piece Design

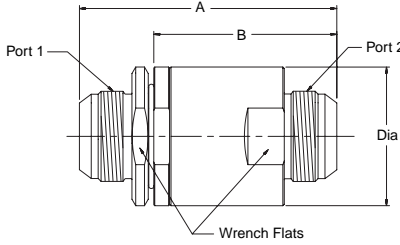

Part Number	A	B	Hex 1	Hex 2	Port 1	Port 2
PS410303-4-4	2.86" 72.6 mm	1.87" 47.5 mm	.75" 19.0 mm	1.19" 30.2 mm	7/16-20 UNF	7/16-20 UNF
PS610303-6-6	2.92" 74.1 mm	1.90" 48.3 mm	.88" 22.2 mm	1.31" 33.3 mm	9/16-18 UNF	9/16-18 UNF
PS810303-8-8	3.19" 81.1 mm	2.09" 53.1 mm	1.12" 28.6 mm	1.50" 36.5 mm	3/4-16 UNF	3/4-16 UNF
PS810303-10-10	3.39" 86.2 mm	2.19" 55.6 mm	1.12" 28.6 mm	1.50" 36.5 mm	7/8-14 UNF	7/8-14 UNF
PS1210303-12-12	3.66" 92.9 mm	2.30" 58.4 mm	1.38" 35.0 mm	1.69" 42.9 mm	1-1/16-12 UN	1-1/16-12 UN
PS1610303-16-16	3.88" 98.6 mm	2.45" 62.2 mm	1.62" 41.3 mm	1.88" 47.6 mm	1-5/16-12 UN	1-5/16-12 UN

Part Number	A	B	Wrench Flats	Dia.	Port 1	Port 2
PS2410303-20-20	5.31" 134.8 mm	3.78" 95.9 mm	2.63" 66.7 mm	2.88" 73.0 mm	1 5/8-12 UN	1 5/8-12 UN
PS2410303-24-24	5.31" 134.8 mm	3.78" 95.9 mm	2.63" 66.7 mm	2.88" 73.0 mm	1 7/8-12 UN	1 7/8-12 UN
PS3210303-32-32	6.20" 157.5 mm	4.28" 108.6 mm	3.06" 77.6 mm	3.35" 85.1 mm	2 1/2-12 UN	2 1/2-12 UN

Male 37° Flare - Female 37° Flare

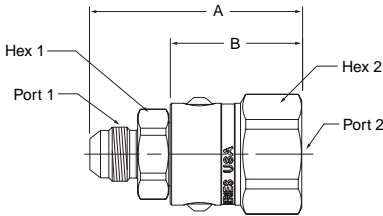

Part Number	A	B	Hex 1	Hex 2	Port 1	Port 2
PS410306-4-4	2.72" 69.1 mm	1.73" 43.9 mm	.75" 19.0 mm	1.19" 30.2 mm	7/16-20 UNF	7/16-20 UNF
PS610306-6-6	2.77" 70.3 mm	1.75" 44.5 mm	.88" 22.2 mm	1.31" 33.3 mm	9/16-18 UNF	9/16-18 UNF
PS810306-8-8	2.91" 74.0 mm	1.81" 46.0 mm	1.12" 28.6 mm	1.50" 36.5 mm	3/4-16 UNF	3/4-16 UNF
PS1210306-12-12	3.38" 85.8 mm	2.02" 51.3 mm	1.38" 35.0 mm	1.69" 42.9 mm	1-1/16-12 UN	1-1/16-12 UN
PS1610306-16-16	3.62" 92.0 mm	2.19" 55.6 mm	1.62" 41.3 mm	1.88" 47.6 mm	1-5/16-12 UN	1-5/16-12 UN

Male 37° Flare - Female SAE Straight Thread

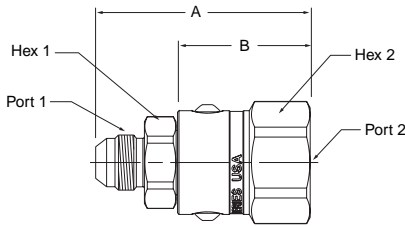

3 Piece Design

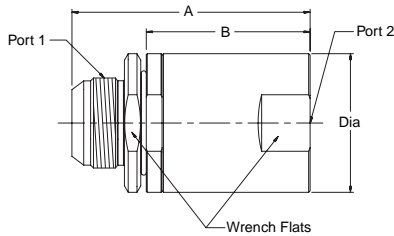

Part Number	A	B	Hex 1	Hex 2	Port 1	Port 2
PS410310-4-4	2.71" 68.8 mm	1.72" 43.7 mm	.75" 19.0 mm	1.19" 30.2 mm	7/16-20 UNF	7/16-20 UNF
PS610310-6-6	2.74" 69.6 mm	1.72" 43.7 mm	.88" 22.2 mm	1.31" 33.3 mm	9/16-18 UNF	9/16-18 UNF
PS810310-8-8	2.89" 73.5 mm	1.79" 45.5 mm	1.12" 28.6 mm	1.50" 36.5 mm	3/4-16 UNF	3/4-16 UNF
PS1210310-12-12	3.44" 87.3 mm	2.08" 52.8 mm	1.38" 35.0 mm	1.69" 42.9 mm	1-1/16-12 UN	1-1/16-12 UN
PS1610310-16-16	3.63" 92.2 mm	2.20" 55.9 mm	1.62" 41.3 mm	1.88" 47.6 mm	1-5/16-12 UN	1-5/16-12 UN

Part Number	A	B	C	D	Dia.	Wrench Flats	Port 1	Port 2
PS2410310-20-20	6.16" 150.2 mm	4.63" 117.5 mm	3.43" 87.0 mm	1.27" 32.3 mm	2.63" 66.7 mm	3.36" 85.2 mm	1 5/8-12 UN	1 5/8-12 UN
PS2410310-24-24	6.16" 150.2 mm	4.63" 117.5 mm	3.43" 87.0 mm	1.27" 32.3 mm	2.63" 66.7 mm	3.36" 85.2 mm	1 7/8-12 UN	1 7/8-12 UN
PS3210310-32-32	7.38" 187.4 mm	5.45" 138.4 mm	3.93" 99.7 mm	1.52" 38.5 mm	3.06" 77.6 mm	4.19" 106.4 mm	2 1/2-12 UN	2 1/2-12 UN

D Swivels

Male SAE O-Ring Straight Thread - Female Pipe

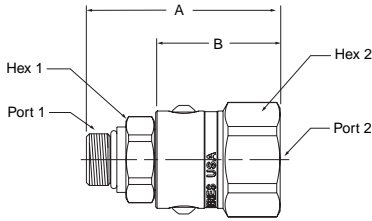

Part Number	A	B	Hex 1	Hex 2	Port 1	Port 2
PS410502-4-4	2.44" 62.1 mm	1.60" 40.6 mm	.75" 19.0 mm	1.19" 30.2 mm	7/16-20 UNF	1/4-18 NPTF
PS610502-6-6	2.48" 63.0 mm	1.64" 41.7 mm	.88" 22.2 mm	1.31" 33.3 mm	9/16-18 UNF	3/8-18 NPTF
PS810502-8-8	2.79" 70.8 mm	1.79" 45.5 mm	1.12" 28.6 mm	1.50" 36.5 mm	3/4-16 UNF	1/2-14 NPTF
PS1210502-12-12	3.02" 76.7 mm	1.85" 47.0 mm	1.38" 35.0 mm	1.69" 42.9 mm	1-1/16-12 UN	3/4-14 NPTF
PS1610502-16-16	3.31" 84.1 mm	2.11" 53.5 mm	1.62" 41.3 mm	1.88" 47.6 mm	1-5/16-12 UN	1-11 1/2 NPTF

Male SAE O-Ring Straight Thread - Male 37° Flare

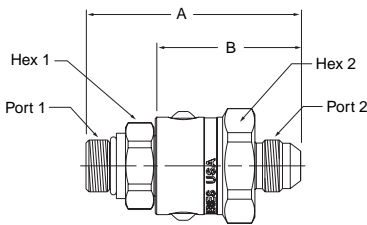

Part Number	A	B	Hex 1	Hex 2	Port 1	Port 2
PS410503-4-4	2.71" 68.9 mm	1.87" 47.5 mm	.75" 19.0 mm	1.19" 30.2 mm	7/16-20 UNF	7/16-20 UNF
PS610503-6-6	2.74" 69.6 mm	1.90" 48.3 mm	.88" 22.2 mm	1.31" 33.3 mm	9/16-18 UNF	9/16-18 UNF
PS810503-8-8	3.09" 78.4 mm	2.09" 53.1 mm	1.12" 28.6 mm	1.50" 36.5 mm	3/4-16 UNF	3/4-16 UNF
PS810503-10-10	3.25" 82.5 mm	2.19" 55.6 mm	1.12" 28.6 mm	1.50" 36.5 mm	7/8-14 UNF	7/8-14 UNF
PS1210503-12-12	3.47" 88.2 mm	2.30" 58.4 mm	1.38" 35.0 mm	1.69" 42.9 mm	1-1/16-12 UN	1-1/16-12 UN
PS1610503-16-16	3.66" 92.9 mm	2.45" 62.2 mm	1.62" 41.3 mm	1.88" 47.6 mm	1-5/16-12 UN	1-5/16-12 UN

Male SAE O-Ring Straight Thread - Female 37° Flare

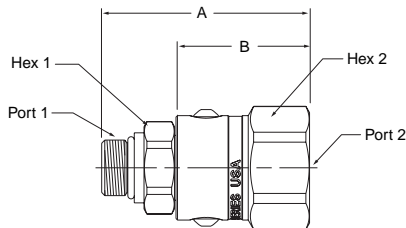

Part Number	A	B	Hex 1	Hex 2	Port 1	Port 2
PS410506-4-4	2.57" 65.4 mm	1.73" 43.9 mm	.75" 19.0 mm	1.19" 30.2 mm	7/16-20 UNF	7/16-20 UNF
PS610506-6-6	2.59" 65.8 mm	1.75" 44.5 mm	.88" 22.2 mm	1.31" 33.3 mm	9/16-18 UNF	9/16-18 UNF
PS810506-8-8	2.81" 71.3 mm	1.81" 46.0 mm	1.12" 28.6 mm	1.50" 36.5 mm	3/4-16 UNF	3/4-16 UNF
PS1210506-12-12	3.19" 81.1 mm	2.02" 51.3 mm	1.38" 35.0 mm	1.69" 42.9 mm	1-1/16-12 UN	1-1/16-12 UN
PS1610506-16-16	3.40" 86.3 mm	2.19" 55.6 mm	1.62" 41.3 mm	1.88" 47.6 mm	1-5/16-12 UN	1-5/16-12 UN

Male SAE O-Ring Straight Thread - Female SAE Straight Thread

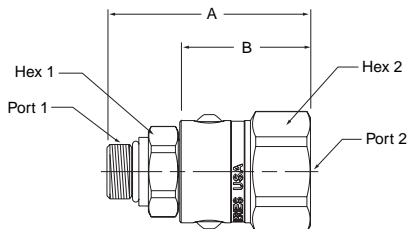

Part Number	A	B	Hex 1	Hex 2	Port 1	Port 2
PS410510-4-4	2.56" 65.0 mm	1.72" 43.7 mm	.75" 19.0 mm	1.19" 30.2 mm	7/16-20 UNF	7/16-20 UNF
PS610510-6-6	2.56" 65.0 mm	1.72" 43.7 mm	.88" 22.2 mm	1.31" 33.3 mm	9/16-18 UNF	9/16-18 UNF
PS810510-8-8	2.79" 70.8 mm	1.79" 45.5 mm	1.12" 28.6 mm	1.50" 36.5 mm	3/4-16 UNF	3/4-16 UNF
PS1210510-12-12	3.25" 82.6 mm	2.08" 52.8 mm	1.38" 35.0 mm	1.69" 42.9 mm	1-1/16-12 UN	1-1/16-12 UN
PS1610510-16-16	3.41" 86.5 mm	2.20" 55.9 mm	1.62" 41.3 mm	1.88" 47.6 mm	1-5/16-12 UN	1-5/16-12 UN

Female SAE Straight Thread - Female Pipe

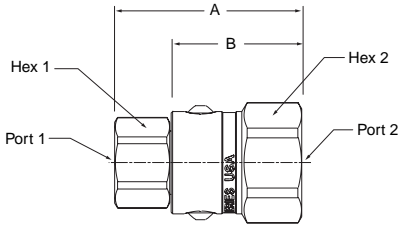

Part Number	A	B	Hex 1	Hex 2	Port 1	Port 2
PS411002-4-4	2.16" 55.0 mm	1.60" 40.6 mm	.75" 19.0 mm	1.19" 30.2 mm	7/16-20 UNF	1/4-18 NPTF
PS611002-6-6	2.30" 58.3 mm	1.64" 41.7 mm	.88" 22.2 mm	1.31" 33.3 mm	9/16-18 UNF	3/8-18 NPTF
PS811002-8-8	2.56" 65.0 mm	1.79" 45.5 mm	1.12" 28.6 mm	1.50" 36.5 mm	3/4-16 UNF	1/2-14 NPTF
PS1211002-12-12	2.88" 73.1 mm	1.85" 47.0 mm	1.38" 35.0 mm	1.69" 42.9 mm	1-1/16-12 UN	3/4-14 NPTF
PS1611002-16-16	3.16" 80.1 mm	2.11" 53.5 mm	1.62" 41.3 mm	1.88" 47.6 mm	1-5/16-12 UN	1-11 1/2 NPTF

Female SAE Straight Thread - Male 37° Flare

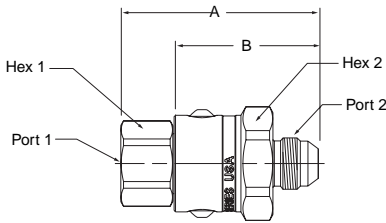

Part Number	A	B	Hex 1	Hex 2	Port 1	Port 2
PS411003-4-4	2.43" 61.8 mm	1.87" 47.5 mm	.75" 19.0 mm	1.19" 30.2 mm	7/16-20 UNF	7/16-20 UNF
PS611003-6-6	2.56" 65.0 mm	1.90" 48.3 mm	.88" 22.2 mm	1.31" 33.3 mm	9/16-18 UNF	9/16-18 UNF
PS811003-8-8	2.86" 72.7 mm	2.09" 53.1 mm	1.12" 28.6 mm	1.50" 36.5 mm	3/4-16 UNF	3/4-16 UNF
PS1211003-12-12	3.33" 84.5 mm	2.30" 58.4 mm	1.38" 35.0 mm	1.69" 42.9 mm	1-1/16-12 UN	1-1/16-12 UN
PS1611003-16-16	3.50" 88.9 mm	2.45" 62.2 mm	1.62" 41.3 mm	1.88" 47.6 mm	1-5/16-12 UN	1-5/16-12 UN

Female SAE Straight Thread - Female 37° Flare

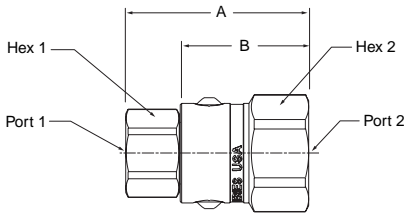

Part Number	A	B	Hex 1	Hex 2	Port 1	Port 2
PS411006-4-4	2.29" 58.3 mm	1.73" 43.9 mm	.75" 19.0 mm	1.19" 30.2 mm	7/16-20 UNF	7/16-20 UNF
PS611006-6-6	2.41" 61.1 mm	1.75" 44.5 mm	.88" 22.2 mm	1.31" 33.3 mm	9/16-18 UNF	9/16-18 UNF
PS811006-8-8	2.58" 65.6 mm	1.81" 46.0 mm	1.12" 28.6 mm	1.50" 36.5 mm	3/4-16 UNF	3/4-16 UNF
PS1211006-12-12	3.05" 77.4 mm	2.02" 51.3 mm	1.38" 35.0 mm	1.69" 42.9 mm	1-1/16-12 UN	1-1/16-12 UN
PS1611006-16-16	3.24" 82.3 mm	2.19" 55.6 mm	1.62" 41.3 mm	1.88" 47.6 mm	1-5/16-12 UN	1-5/16-12 UN

Female SAE Straight Thread - Female SAE Straight Thread

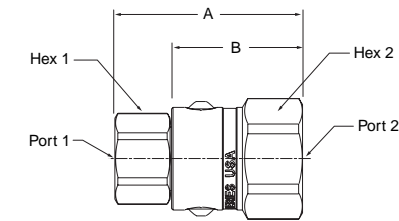

Part Number	A	B	Hex 1	Hex 2	Port 1	Port 2
PS411010-4-4	2.28" 58.0 mm	1.72" 43.7 mm	.75" 19.0 mm	1.19" 30.2 mm	7/16-20 UNF	7/16-20 UNF
PS611010-6-6	2.38" 60.4 mm	1.72" 43.7 mm	.88" 22.2 mm	1.31" 33.3 mm	9/16-18 UNF	9/16-18 UNF
PS811010-8-8	2.56" 65.0 mm	1.79" 45.5 mm	1.12" 28.6 mm	1.50" 36.5 mm	3/4-16 UNF	3/4-16 UNF
PS1211010-12-12	3.11" 78.9 mm	2.08" 52.8 mm	1.38" 35.0 mm	1.69" 42.9 mm	1-1/16-12 UN	1-1/16-12 UN
PS1611010-16-16	3.25" 82.6 mm	2.20" 55.9 mm	1.62" 41.3 mm	1.88" 47.6 mm	1-5/16-12 UN	1-5/16-12 UN

3 Piece Design

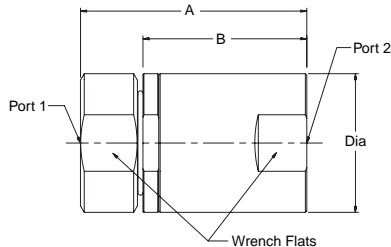

Part Number	A	B	C	D	Wrench Flats	Dia.	Port 1	Port 2
PS2411010-20-20	5.91" 150.2 mm	4.63" 117.5 mm	3.43" 87.0 mm	1.27" 32.3 mm	2.63" 66.7 mm	3.36" 85.2 mm	1 5/8-12 UN	1 5/8-12 UN
PS2411010-24-24	5.91" 150.2 mm	4.63" 117.5 mm	3.43" 87.0 mm	1.27" 32.3 mm	2.63" 66.7 mm	3.36" 85.2 mm	1 7/8-12 UN	1 7/8-12 UN
PS3211010-32-32	6.83" 173.6 mm	5.45" 138.4 mm	3.93" 99.7 mm	1.52" 38.5 mm	3.06" 77.6 mm	4.19" 106.4 mm	2 1/2-12 UN	2-1/2-12 UN

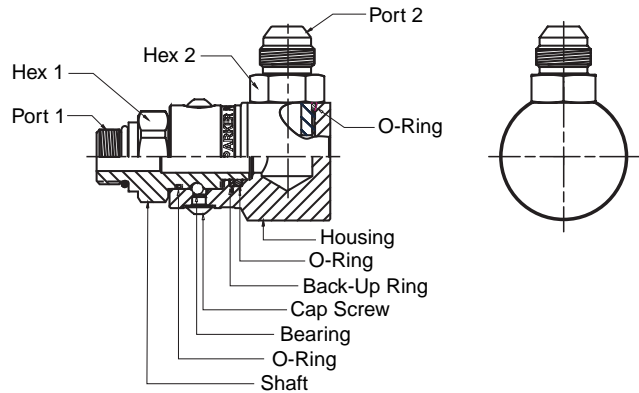

Materials Of Construction

- Housing*:Carbon Steel
- Shaft*:Carbon Steel
- Plating*:Chromium-6 Free
- Bearing*:Chrome
- O-Rings*:Nitrile
- Back-Up Ring:PTFE

* See How-To-Order for optional material plating and seals.

D Swivels

Male Pipe - Female Pipe

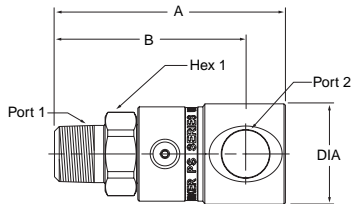

Part Number	A	B	Dia.	Hex 1	Port 1	Port 2
PS490102-4-4	2.85" 72.3 mm	2.44" 62.0 mm	1.20" 30.5 mm	.75" 19.0 mm	1/4-18 NPTF	1/4-18 NPTF
PS690102-6-6	3.05" 77.4 mm	2.54" 64.4 mm	1.29" 32.8 mm	.88" 22.2 mm	3/8-18 NPTF	3/8-18 NPTF
PS890102-8-8	3.43" 87.0 mm	2.84" 72.0 mm	1.49" 37.8 mm	1.12" 28.6 mm	1/2-14 NPTF	1/2-14 NPTF
PS1290102-12-12	3.66" 93.0 mm	3.00" 76.1 mm	1.76" 44.6 mm	1.38" 35.0 mm	3/4-14 NPTF	3/4-14 NPTF
PS1690102-16-16	4.41" 112.0 mm	3.54" 90.0 mm	2.16" 54.9 mm	1.62" 41.3 mm	1-11 1/2 NPTF	1-11 1/2 NPTF

Male Pipe - Male 37° Flare

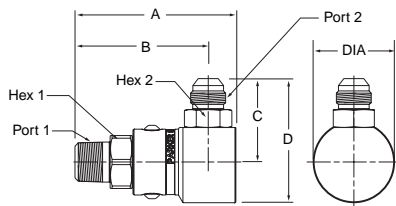

Part Number	A	B	C	D	Dia	Hex 1	Hex 2	Port 1	Port 2
PS490103-4-4	2.85" 72.3 mm	2.44" 62.0 mm	1.39" 35.2 mm	1.99" 50.5 mm	1.20" 30.5 mm	.75" 19.0 mm	.56" 14.3 mm	1/4-18 NPTF	7/16-20 UNF
PS690103-6-6	3.05" 77.4 mm	2.54" 64.4 mm	1.44" 36.6 mm	2.09" 53.0 mm	1.29" 32.8 mm	.88" 22.2 mm	.69" 17.5 mm	3/8-18 NPTF	9/16-18 UNF
PS890103-8-8	3.43" 87.0 mm	2.84" 72.0 mm	1.78" 45.1 mm	2.64" 67.1 mm	1.73" 44.0 mm	1.12" 28.6 mm	.88" 22.2 mm	1/2-14 NPTF	3/4-16 UNF
PS1290103-12-12	3.66" 93.0 mm	3.00" 76.1 mm	2.24" 56.9 mm	3.86" 85.3 mm	2.17" 55.2 mm	1.38" 35.0 mm	1.25" 31.8 mm	3/4-14 NPTF	1-1/16-12 UN
PS1690103-16-16	4.41" 112.0 mm	3.54" 90.0 mm	2.42" 61.3 mm	3.66" 92.9 mm	2.48" 63.0 mm	1.62" 41.3 mm	1.50" 38.1 mm	1-11 1/2 NPTF	1-5/16-12 UN

Male Pipe - Male SAE O-Ring Straight Thread

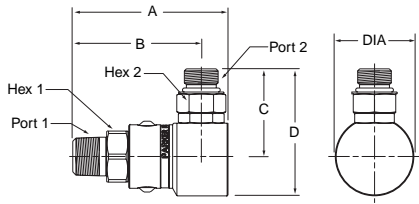

Part Number	A	B	C	D	Dia.	Hex 1	Hex 2	Port 1	Port 2
PS490105-4-4	2.85" 72.3 mm	2.44" 62.0 mm	1.38" 35.0 mm	1.98" 50.2 mm	1.20" 30.5 mm	.75" 19.0 mm	.56" 14.3 mm	1/4-18 NPTF	7/16-20 UNF
PS690105-6-6	3.05" 77.4 mm	2.54" 64.4 mm	1.55" 39.4 mm	2.20" 55.8 mm	1.29" 32.8 mm	.88" 22.2 mm	.69" 17.5 mm	3/8-18 NPTF	9/16-18 UNF
PS890105-8-8	3.43" 87.0 mm	2.84" 72.0 mm	1.86" 47.2 mm	2.72" 69.2 mm	1.73" 44.0 mm	1.12" 28.6 mm	.88" 22.2 mm	1/2-14 NPTF	3/4-16 UNF
PS1290105-12-12	3.66" 93.0 mm	3.00" 76.1 mm	2.40" 61.0 mm	3.49" 88.5 mm	2.17" 55.2 mm	1.38" 35.0 mm	1.25" 31.8 mm	3/4-14 NPTF	1-1/16-12 UN
PS1690105-16-16	4.41" 112.0 mm	3.54" 90.0 mm	2.50" 63.4 mm	3.74" 94.9 mm	2.48" 63.0 mm	1.62" 41.3 mm	1.50" 38.1 mm	1-11/2 NPTF	1-5/16-12 UN

Male Pipe - Female 37° Flare

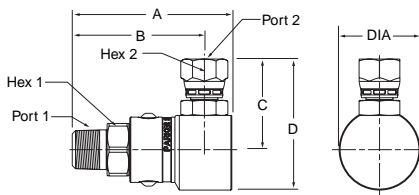

Part Number	A	B	C	D	Dia.	Hex 1	Hex 2	Port 1	Port 2
PS490106-4-4	2.85" 72.3 mm	2.44" 62.0 mm	1.47" 37.3 mm	2.07" 52.5 mm	1.20" 30.5 mm	.75" 19.0 mm	.56" 14.3 mm	1/4-18 NPTF	7/16-20 UNF
PS690106-6-6	3.05" 77.4 mm	2.54" 64.4 mm	1.57" 39.9 mm	2.22" 56.3 mm	1.29" 32.8 mm	.88" 22.2 mm	.69" 17.5 mm	3/8-18 NPTF	9/16-18 UNF
PS890106-8-8	3.43" 87.0 mm	2.84" 72.0 mm	1.91" 48.4 mm	2.77" 70.4 mm	1.73" 44.0 mm	1.12" 28.6 mm	.88" 22.2 mm	1/2-14 NPTF	3/4-16 UNF
PS1290106-12-12	3.66" 93.0 mm	3.00" 76.1 mm	2.34" 59.4 mm	3.43" 87.0 mm	2.17" 55.2 mm	1.38" 35.0 mm	1.25" 31.8 mm	3/4-14 NPTF	1-1/16-12 UN
PS1690106-16-16	4.41" 112.0 mm	3.54" 90.0 mm	2.54" 64.6 mm	3.79" 96.2 mm	2.48" 63.0 mm	1.62" 41.3 mm	1.50" 38.1 mm	1-11/2 NPTF	1-5/16-12 UN

Male Pipe - Female NPSM Pipe Swivel

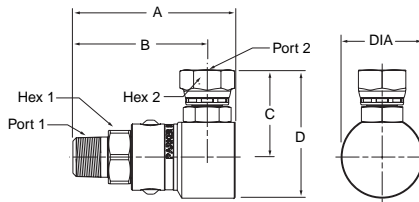

Part Number	A	B	C	D	Dia.	Hex 1	Hex 2	Port 1	Port 2
PS490107-4-4	2.85" 72.3 mm	2.44" 62.0 mm	1.48" 37.5 mm	2.08" 52.8 mm	1.20" 30.5 mm	.75" 19.0 mm	.69" 17.4 mm	1/4-18 NPTF	1/4-18 NPSM
PS690107-6-6	3.05" 77.4 mm	2.54" 64.4 mm	1.51" 38.4 mm	2.16" 54.8 mm	1.29" 32.8 mm	.88" 22.2 mm	.88" 22.2 mm	3/8-18 NPTF	3/8-18 NPSM
PS890107-8-8	3.43" 87.0 mm	2.84" 72.0 mm	1.86" 47.2 mm	2.72" 69.2 mm	1.73" 44.0 mm	1.12" 28.6 mm	1.00" 25.4 mm	1/2-14 NPTF	1/2-14 NPSM
PS1290107-12-12	3.66" 93.0 mm	3.00" 76.1 mm	2.24" 56.9 mm	3.33" 84.5 mm	2.17" 55.2 mm	1.38" 35.0 mm	1.25" 31.8 mm	3/4-14 NPTF	3/4-14 NPSM
PS1690107-16-16	4.41" 112.0 mm	3.54" 90.0 mm	2.48" 63.1 mm	3.73" 94.6 mm	2.48" 63.0 mm	1.62" 41.3 mm	1.50" 38.1 mm	1-11/2 NPTF	1-11/2 NPSM

Male Pipe - Female SAE Straight Thread

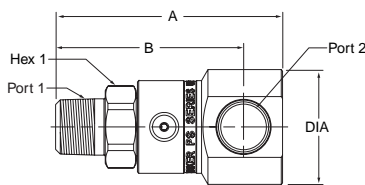

Part Number	A	B	Dia.	Hex 1	Port 1	Port 2
PS490110-4-4	2.85" 72.3 mm	2.44" 62.0 mm	1.20" 30.5 mm	.75" 19.0 mm	1/4-18 NPTF	7/16-20 UNF
PS690110-6-6	3.05" 77.4 mm	2.54" 64.4 mm	1.29" 32.8 mm	.88" 22.2 mm	3/8-18 NPTF	9/16-18 UNF
PS890110-8-8	3.43" 87.0 mm	2.84" 72.0 mm	1.73" 44.0 mm	1.12" 28.6 mm	1/2-14 NPTF	3/4-16 UNF
PS1290110-12-12	3.66" 93.0 mm	3.00" 76.1 mm	2.17" 55.2 mm	1.38" 35.0 mm	3/4-14 NPTF	1-1/16-12 UN
PS1690110-16-16	4.41" 112.0 mm	3.54" 90.0 mm	2.48" 63.0 mm	1.62" 41.3 mm	1-11/2 NPTF	1-5/16-12 UN

Male Pipe - O-Ring Face Seal

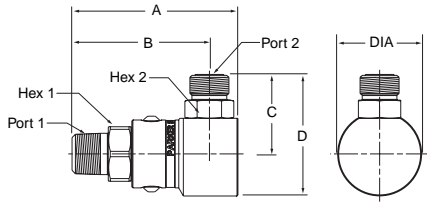

Part Number	A	B	C	D	Dia.	Hex 1	Hex 2	Port 1	Port 2
PS4901JM-4-4	2.85" 72.3 mm	2.44" 62.0 mm	1.29" 32.5 mm	1.89" 47.9 mm	1.20" 30.5 mm	.75" 19.0 mm	.56" 14.3 mm	1/4-18 NPTF	9/16-18 UNF
PS6901JM-6-6	3.05" 77.4 mm	2.54" 64.4 mm	1.40" 35.6 mm	2.05" 52.0 mm	1.29" 32.8 mm	.88" 22.2 mm	.69" 17.5 mm	3/8-18 NPTF	11/16-16 UN
PS8901JM-8-8	3.43" 87.0 mm	2.84" 72.0 mm	1.74" 44.1 mm	2.60" 66.1 mm	1.73" 44.0 mm	1.12" 28.6 mm	.88" 22.2 mm	1/2-14 NPTF	13/16-16 UN
PS12901JM-12-12	3.66" 93.0 mm	3.00" 76.1 mm	2.18" 55.4 mm	3.27" 83.0 mm	2.17" 55.2 mm	1.38" 35.0 mm	1.25" 31.8 mm	3/4-14 NPTF	1-3/16-12 UN
PS16901JM-16-16	4.41" 112.0 mm	3.54" 90.0 mm	2.34" 59.6 mm	3.59" 91.1 mm	2.48" 63.0 mm	1.62" 41.3 mm	1.50" 38.1 mm	1-11/2 NPTF	1-7/16-12 UN

Female Pipe - Female Pipe

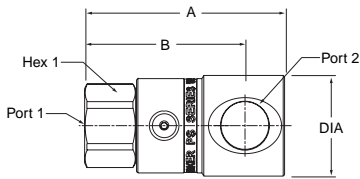

Part Number	A	B	Dia	Hex 1	Port 1	Port 2
PS490202-4-4	2.42" 61.4 mm	2.01" 51.2 mm	1.20" 30.5 mm	.75" 19.0 mm	1/4-18 NPTF	1/4-18 NPTF
PS690202-6-6	2.68" 68.2 mm	2.17" 55.2 mm	1.29" 32.8 mm	.88" 22.2 mm	3/8-18 NPTF	3/8-18 NPTF
PS890202-8-8	2.96" 75.3 mm	2.37" 60.3 mm	1.49" 37.8 mm	1.12" 28.6 mm	1/2-14 NPTF	1/2-14 NPTF
PS1290202-12-12	3.43" 87.2 mm	2.77" 70.4 mm	1.76" 44.6 mm	1.38" 35.0 mm	3/4-14 NPTF	3/4-14 NPTF
PS1690202-16-16	4.03" 102.3 mm	3.16" 80.3 mm	2.16" 54.9 mm	1.62" 41.3 mm	1-11/2 NPTF	1-11/2 NPTF

3 Piece Design

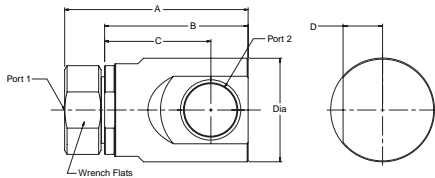

Part Number	A	B	C	D	Wrench Flats	Dia.	Port 1	Port 2
PS2490202-20-20	5.91" 150.2 mm	4.63" 117.5 mm	3.43" 87.0 mm	1.27" 32.3 mm	2.63" 66.7 mm	3.36" 85.2 mm	1 1/4-11 1/2 NPTF	1 1/4-11 1/2 NPTF
PS2490202-24-24	5.91" 150.2 mm	4.63" 117.5 mm	3.43" 87.0 mm	1.27" 32.3 mm	2.63" 66.7 mm	3.36" 85.2 mm	1 1/2-11 1/2 NPTF	1 1/2-11 1/2 NPTF
PS3290202-32-32	6.75" 171.5 mm	5.45" 138.4 mm	3.93" 99.7 mm	1.52" 38.5 mm	3.06" 77.6 mm	4.19" 106.4 mm	2 11-1/2 NPTF	2 11-1/2 NPTF

Female Pipe - Male 37° Flare

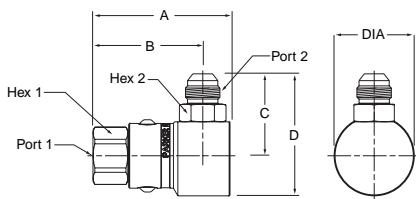

Part Number	A	B	C	D	Dia	Hex 1	Hex 2	Port 1	Port 2
PS490203-4-4	2.42" 61.4 mm	2.01" 51.2 mm	1.39" 35.2 mm	1.99" 50.5 mm	1.20" 30.5 mm	.75" 19.0 mm	.56" 14.3 mm	1/4-18 NPTF	7/16-20 UNF
PS690203-6-6	2.68" 68.2 mm	2.17" 55.2 mm	1.44" 36.6 mm	2.09" 53.0 mm	1.29" 32.8 mm	.88" 22.2 mm	.69" 17.5 mm	3/8-18 NPTF	9/16-18 UNF
PS890203-8-8	2.96" 75.3 mm	2.37" 60.3 mm	1.78" 45.1 mm	2.64" 67.1 mm	1.73" 44.0 mm	1.12" 28.6 mm	.88" 22.2 mm	1/2-14 NPTF	3/4-16 UNF
PS1290203-12-12	3.43" 87.2 mm	2.77" 70.4 mm	2.24" 56.9 mm	3.86" 98.3 mm	2.17" 55.2 mm	1.38" 35.0 mm	1.25" 31.8 mm	3/4-14 NPTF	1-1/16-12 UN
PS1690203-16-16	4.03" 102.3 mm	3.16" 80.3 mm	2.42" 61.3 mm	3.66" 92.9 mm	2.48" 63.0 mm	1.62" 41.3 mm	1.50" 38.1 mm	1-11/2 NPTF	1-5/16-12 UN

3 Piece Design

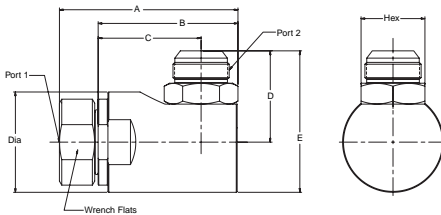

Part Number	A	B	C	D	E	Hex	Wrench Flats	Dia.	Port 1	Port 2
PS2490203-20-20	5.91" 150.2 mm	4.63" 117.5 mm	3.43" 87.0 mm	2.85" 72.4 mm	4.53" 115.0 mm	1.88" 47.6 mm	2.63" 66.7 mm	3.36" 85.2 mm	1 1/4-11 1/2 NPTF	1 5/8-12 UN
PS2490203-24-24	5.94" 150.9 mm	4.65" 118.2 mm	3.43" 87.0 mm	3.05" 77.6 mm	4.73" 120.2 mm	2.13" 54.0 mm	2.63" 66.7 mm	3.36" 85.2 mm	1 1/2-11 1/2 NPTF	1 7/8-12 UN
PS3290203-32-32	6.82" 173.1 mm	5.51" 140.0 mm	3.93" 99.7 mm	3.70" 94.0 mm	5.80" 147.2 mm	2.75" 69.8 mm	3.06" 77.6 mm	4.19" 106.4 mm	2 11-1/2 NPTF	2 1/2-12 UN

D Swivels

Female Pipe - Male SAE O-Ring Straight Thread

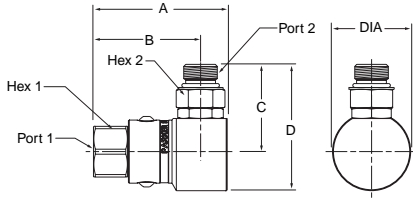

Part Number	A	B	C	D	Dia.	Hex 1	Hex 2	Port 1	Port 2
PS490205-4-4	2.42" 61.4 mm	2.01" 51.2 mm	1.38" 35.0 mm	1.98" 50.2 mm	1.20" 30.5 mm	.75" 19.0 mm	.56" 14.3 mm	1/4-18 NPTF	7/16-20 UNF
PS690205-6-6	2.68" 68.2 mm	2.17" 55.2 mm	1.55" 39.4 mm	2.20" 55.8 mm	1.29" 32.8 mm	.88" 22.2 mm	.69" 17.5 mm	3/8-18 NPTF	9/16-18 UNF
PS890205-8-8	2.96" 75.3 mm	2.37" 60.3 mm	1.86" 47.2 mm	2.72" 69.2 mm	1.73" 44.0 mm	1.12" 28.6 mm	.88" 22.2 mm	1/2-14 NPTF	3/4-16 UNF
PS1290205-12-12	3.43" 87.2 mm	2.77" 70.4 mm	2.40" 61.0 mm	3.49" 88.5 mm	2.17" 55.2 mm	1.38" 35.0 mm	1.25" 31.8 mm	3/4-14 NPTF	1-1/16-12 UN
PS1690205-16-16	4.03" 102.3 mm	3.16" 80.3 mm	2.50" 63.4 mm	3.74" 94.9 mm	2.48" 63.0 mm	1.62" 41.3 mm	1.50" 38.1 mm	1-11/2 NPTF	1-5/16-12 UN

Female Pipe - Female 37° Flare

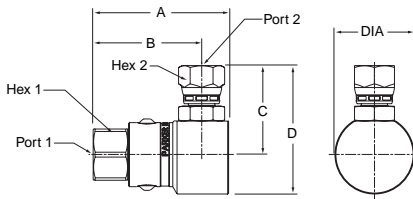

Part Number	A	B	C	D	Dia.	Hex 1	Hex 2	Port 1	Port 2
PS490206-4-4	2.42" 61.4 mm	2.01" 51.2 mm	1.47" 37.3 mm	2.07" 52.5 mm	1.20" 30.5 mm	.75" 19.0 mm	.56" 14.3 mm	1/4-18 NPTF	7/16-20 UNF
PS690206-6-6	2.68" 68.2 mm	2.17" 55.2 mm	1.57" 39.9 mm	2.22" 56.3 mm	1.29" 32.8 mm	.88" 22.2 mm	.69" 17.5 mm	3/8-18 NPTF	9/16-18 UNF
PS890206-8-8	2.96" 75.3 mm	2.37" 60.3 mm	1.91" 48.4 mm	2.77" 70.4 mm	1.73" 44.0 mm	1.12" 28.6 mm	.88" 22.2 mm	1/2-14 NPTF	3/4-16 UNF
PS1290206-12-12	3.43" 87.2 mm	2.77" 70.4 mm	2.34" 59.4 mm	3.43" 87.0 mm	2.17" 55.2 mm	1.38" 35.0 mm	1.25" 31.8 mm	3/4-14 NPTF	1-1/16-12 UN
PS1690206-16-16	4.03" 102.3 mm	3.16" 80.3 mm	2.54" 64.6 mm	3.79" 96.2 mm	2.48" 63.0 mm	1.62" 41.3 mm	1.50" 38.1 mm	1-11/2 NPTF	1-5/16-12 UN

Female Pipe - Female NPSM Pipe Swivel

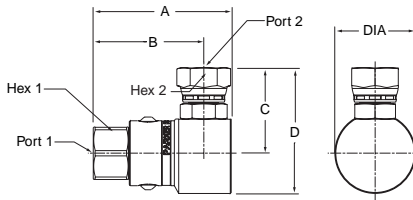

Part Number	A	B	C	D	Dia.	Hex 1	Hex 2	Port 1	Port 2
PS490207-4-4	2.42" 61.4 mm	2.01" 51.2 mm	1.48" 37.5 mm	2.08" 52.8 mm	1.20" 30.5 mm	.75" 19.0 mm	.69" 17.4 mm	1/4-18 NPTF	1/4-18 NPSM
PS690207-6-6	2.68" 68.2 mm	2.17" 55.2 mm	1.51" 38.4 mm	2.16" 54.8 mm	1.29" 32.8 mm	.88" 22.2 mm	.88" 22.2 mm	3/8-18 NPTF	3/8-18 NPSM
PS890207-8-8	2.96" 75.3 mm	2.37" 60.3 mm	1.86" 47.2 mm	2.72" 69.2 mm	1.73" 44.0 mm	1.12" 28.6 mm	1.00" 25.4 mm	1/2-14 NPTF	1/2-14 NPSM
PS1290207-12-12	3.43" 87.2 mm	2.77" 70.4 mm	2.24" 56.9 mm	3.33" 84.5 mm	2.17" 55.2 mm	1.38" 35.0 mm	1.25" 31.8 mm	3/4-14 NPTF	3/4-14 NPSM
PS1690207-16-16	4.03" 102.3 mm	3.16" 80.3 mm	2.48" 63.1 mm	3.73" 94.6 mm	2.48" 63.0 mm	1.62" 41.3 mm	1.50" 38.1 mm	1-11/2 NPTF	1-11/2 NPSM

Female Pipe - Female SAE Straight Thread

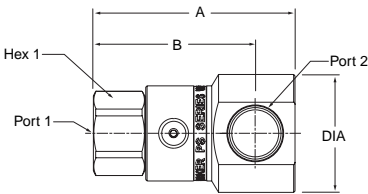

Part Number	A	B	Dia.	Hex 1	Port 1	Port 2
PS490210-4-4	2.42" 61.4 mm	2.01" 51.2 mm	1.20" 30.5 mm	.75" 19.0 mm	1/4-18 NPTF	7/16-20 UNF
PS690210-6-6	2.68" 68.2 mm	2.17" 55.2 mm	1.29" 32.8 mm	.88" 22.2 mm	3/8-18 NPTF	9/16-18 UNF
PS890210-8-8	2.96" 75.3 mm	2.37" 60.3 mm	1.73" 44.0 mm	1.12" 28.6 mm	1/2-14 NPTF	3/4-16 UNF
PS1290210-12-12	3.43" 87.2 mm	2.77" 70.4 mm	2.17" 55.2 mm	1.38" 35.0 mm	3/4-14 NPTF	1-1/16-12 UN
PS1690210-16-16	4.03" 102.3 mm	3.16" 80.3 mm	2.48" 63.0 mm	1.62" 41.3 mm	1-11/2 NPTF	1-5/16-12 UN

3 Piece Design

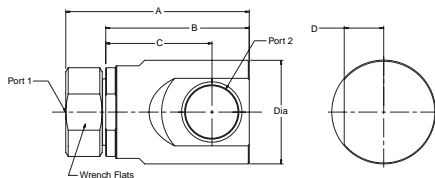

Part Number	A	B	C	D	Wrench Flats	Dia.	Port 1	Port 2
PS2490210-20-20	5.91" 150.2 mm	4.63" 117.5 mm	3.43" 87.0 mm	1.27" 32.3 mm	2.63" 66.7 mm	3.36" 85.2 mm	1 1/4-11 1/2 NPTF	1 5/8-12 UN
PS2490210-24-24	5.91" 150.2 mm	4.63" 117.5 mm	3.43" 87.0 mm	1.27" 32.3 mm	2.63" 66.7 mm	3.36" 85.2 mm	1 1/4-11 1/2 NPTF	1 5/8-12 UN
PS3290210-32-32	6.75" 171.5 mm	5.45" 138.4 mm	3.93" 99.7 mm	1.52" 38.5 mm	3.06" 77.6 mm	4.19" 106.4 mm	2 11/2 NPTF	2-1/2-12 UN

Male 37° Flare - Female Pipe

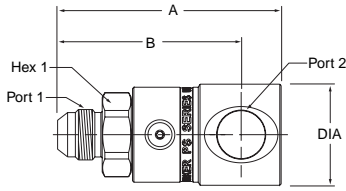

3 Piece Design

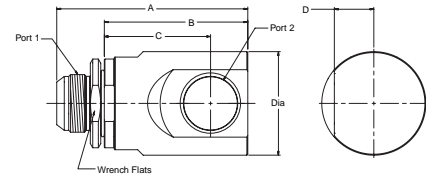

Part Number	A	B	Dia.	Hex 1	Port 1	Port 2
PS490302-4-4	2.85" 72.3 mm	2.44" 62.0 mm	1.20" 30.5 mm	.75" 19.0 mm	7/16-20 UNF	1/4-18 NPTF
PS690302-6-6	3.05" 77.4 mm	2.54" 64.4 mm	1.29" 32.8 mm	.88" 22.2 mm	9/16-18 UNF	3/8-18 NPTF
PS890302-8-8	3.29" 83.7 mm	2.70" 68.7 mm	1.49" 37.8 mm	1.12" 28.6 mm	3/4-16 UNF	1/2-14 NPTF
PS1290302-12-12	3.76" 95.6 mm	3.10" 78.8 mm	1.76" 44.6 mm	1.38" 35.0 mm	1-1/16-12 UN	3/4-14 NPTF
PS1690302-16-16	4.41" 112.0 mm	3.54" 90.0 mm	2.16" 54.9 mm	1.62" 41.3 mm	1-5/16-12 UN	1-11/2 NPTF

Part Number	A	B	C	D	Wrench Flats	Dia.	Port 1	Port 2
PS2490302-20-20	6.16" 150.2 mm	4.63" 117.5 mm	3.43" 87.0 mm	1.27" 32.3 mm	2.63" 66.7 mm	3.36" 85.2 mm	1 5/8-12 UN	1 1/4-11 1/2 NPTF
PS2490302-24-24	6.16" 150.2 mm	4.63" 117.5 mm	3.43" 87.0 mm	1.27" 32.3 mm	2.63" 66.7 mm	3.36" 85.2 mm	1 7/8-12 UN	1 1/2-11 1/2 NPTF
PS3290302-32-32	7.38" 187.4 mm	5.45" 138.4 mm	3.93" 99.7 mm	1.52" 38.5 mm	3.06" 77.6 mm	4.19" 106.4 mm	2 1/2-12 UN	2-11-1/2 NPTF

Male 37° Flare - Male 37° Flare

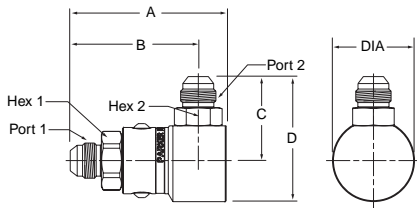

3 Piece Design

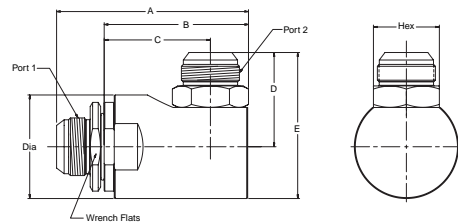

Part Number	A	B	C	D	Dia.	Hex 1	Hex 2	Port 1	Port 2
PS490303-4-4	2.85" 72.3 mm	2.44" 62.0 mm	1.39" 35.2 mm	1.99" 50.5 mm	1.20" 30.5 mm	.75" 19.0 mm	.56" 14.3 mm	7/16-20 UNF	7/16-20 UNF
PS690303-6-6	3.05" 77.4 mm	2.54" 64.4 mm	1.44" 36.6 mm	2.09" 53.0 mm	1.29" 32.8 mm	.88" 22.2 mm	.69" 17.5 mm	9/16-18 UNF	9/16-18 UNF
PS890303-8-8	3.29" 83.7 mm	2.70" 68.7 mm	1.78" 45.1 mm	2.64" 67.1 mm	1.73" 44.0 mm	1.12" 28.6 mm	.88" 22.2 mm	3/4-16 UNF	3/4-16 UNF
PS890303-10-10	3.39" 86.2 mm	2.80" 71.2 mm	1.90" 48.4 mm	2.77" 70.4 mm	1.73" 44.0 mm	1.12" 28.6 mm	.88" 22.2 mm	7/8-14 UNF	7/8-14 UNF
PS1290303-12-12	3.76" 95.6 mm	3.10" 78.8 mm	2.24" 56.9 mm	3.86" 98.5 mm	2.17" 55.2 mm	1.38" 35.0 mm	1.25" 31.8 mm	1-1/16-12 UN	1-1/16-12 UN
PS1690303-16-16	4.41" 112.0 mm	3.54" 90.0 mm	2.42" 61.3 mm	3.66" 92.9 mm	2.48" 63.0 mm	1.62" 41.3 mm	1.50" 38.1 mm	1-5/16-12 UN	1-5/16-12 UN

Part Number	A	B	C	D	E	Hex	Wrench Flats	Dia.	Port 1	Port 2
PS2490303-20-20	6.16" 156.4 mm	4.63" 117.5 mm	3.43" 87.0 mm	2.85" 72.4 mm	4.53" 115.0 mm	1.88" 47.6 mm	2.63" 66.7 mm	3.36" 85.2 mm	1 5/8-12 UN	1 5/8-12 UN
PS2490303-24-24	5.81" 157.1 mm	4.65" 118.2 mm	3.43" 87.0 mm	3.05" 77.6 mm	4.73" 120.2 mm	2.13" 54.0 mm	2.63" 66.7 mm	3.36" 85.2 mm	1 7/8-12 UN	1 7/8-12 UN
PS3290303-32-32	7.44" 189.0 mm	5.51" 140.0 mm	3.93" 99.7 mm	3.70" 94.0 mm	5.80" 147.2 mm	2.75" 69.8 mm	3.06" 77.6 mm	4.19" 106.4 mm	2 1/2-12 UN	2 1/2-12 UN

Male 37° Flare - Male SAE O-Ring Straight Thread

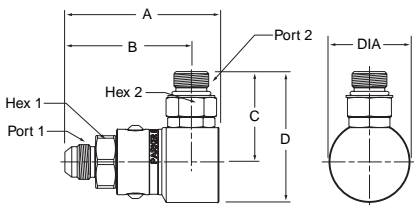

Part Number	A	B	C	D	Dia.	Hex 1	Hex 2	Port 1	Port 2
PS490305-4-4	2.85" 72.3 mm	2.44" 62.0 mm	1.38" 35.0 mm	1.98" 50.2 mm	1.20" 30.5 mm	.75" 19.0 mm	.56" 14.3 mm	7/16-20 UNF	7/16-20 UNF
PS690305-6-6	3.05" 77.4 mm	2.54" 64.4 mm	1.55" 39.4 mm	2.20" 55.8 mm	1.29" 32.8 mm	.88" 22.2 mm	.69" 17.5 mm	9/16-18 UNF	9/16-18 UNF
PS890305-8-8	3.29" 83.7 mm	2.70" 68.7 mm	1.86" 47.2 mm	2.72" 69.2 mm	1.73" 44.0 mm	1.12" 28.6 mm	.88" 22.2 mm	3/4-16 UNF	3/4-16 UNF
PS1290305-12-12	3.76" 95.6 mm	3.10" 78.8 mm	2.40" 61.0 mm	3.49" 88.5 mm	2.17" 55.2 mm	1.38" 35.0 mm	1.25" 31.8 mm	1-1/16-12 UN	1-1/16-12 UN
PS1690305-16-16	4.41" 112.0 mm	3.54" 90.0 mm	2.50" 63.4 mm	3.74" 94.9 mm	2.48" 63.0 mm	1.62" 41.3 mm	1.50" 38.1 mm	1-5/16-12 UN	1-5/16-12 UN

D Swivels

Male 37° Flare - Female 37° Flare

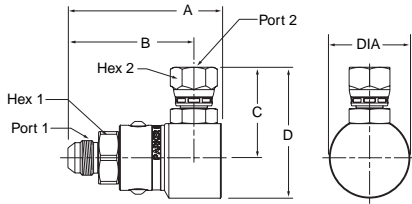

Part Number	A	B	C	D	Dia.	Hex 1	Hex 2	Port 1	Port 2
PS490306-4-4	2.85" 72.3 mm	2.44" 62.0 mm	1.47" 37.3 mm	2.07" 52.5 mm	1.20" 30.5 mm	.75" 19.0 mm	.56" 14.3 mm	7/16-20 UNF	7/16-20 UNF
PS690306-6-6	3.05" 77.4 mm	2.54" 64.4 mm	1.57" 39.9 mm	2.22" 56.3 mm	1.29" 32.8 mm	.88" 22.2 mm	.69" 17.5 mm	9/16-18 UNF	9/16-18 UNF
PS890306-8-8	3.29" 83.7 mm	2.70" 68.7 mm	1.91" 48.4 mm	2.77" 70.4 mm	1.73" 44.0 mm	1.12" 28.6 mm	.88" 22.2 mm	3/4-16 UNF	3/4-16 UNF
PS1290306-12-12	3.76" 95.6 mm	3.10" 78.8 mm	2.34" 59.4 mm	3.43" 87.0 mm	2.17" 55.2 mm	1.38" 35.0 mm	1.25" 31.8 mm	1-1/16-12 UN	1-1/16-12 UN
PS1690306-16-16	4.41" 112.0 mm	3.54" 90.0 mm	2.54" 64.6 mm	3.79" 96.2 mm	2.48" 63.0 mm	1.62" 41.3 mm	1.50" 38.1 mm	1-5/16-12 UN	1-5/16-12 UN

Male 37° Flare - Female NPSM Pipe Swivel

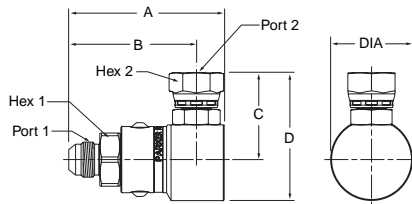

Part Number	A	B	C	D	Dia.	Hex 1	Hex 2	Port 1	Port 2
PS490307-4-4	2.85" 72.3 mm	2.44" 62.0 mm	1.48" 37.5 mm	2.08" 52.8 mm	1.20" 30.5 mm	.75" 19.0 mm	.69" 17.4 mm	7/16-20 UNF	1/4-18 NPSM
PS690307-6-6	3.05" 77.4 mm	2.54" 64.4 mm	1.51" 38.4 mm	2.16" 54.8 mm	1.29" 32.8 mm	.88" 22.2 mm	.88" 22.2 mm	9/16-18 UNF	3/8-18 NPSM
PS890307-8-8	3.29" 83.7 mm	2.70" 68.7 mm	1.86" 47.2 mm	2.72" 69.2 mm	1.73" 44.0 mm	1.12" 28.6 mm	1.00" 25.4 mm	3/4-16 UNF	1/2-14 NPSM
PS1290307-12-12	3.76" 95.6 mm	3.10" 78.8 mm	2.24" 56.9 mm	3.33" 84.5 mm	2.17" 55.2 mm	1.38" 35.0 mm	1.25" 31.8 mm	1-1/16-12 UN	3/4-14 NPSM
PS1690307-16-16	4.41" 112.0 mm	3.54" 90.0 mm	2.48" 63.1 mm	3.73" 94.6 mm	2.48" 63.0 mm	1.62" 41.3 mm	1.50" 38.1 mm	1-5/16-12 UN	1-11 1/2 NPSM

Male 37° Flare - Female SAE Straight Thread

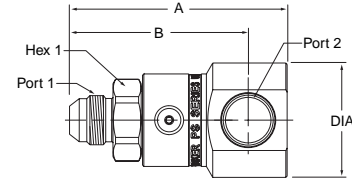

Part Number	A	B	Dia.	Hex 1	Port 1	Port 2
PS490310-4-4	2.85" 72.3 mm	2.44" 62.0 mm	1.20" 30.5 mm	.75" 19.0 mm	7/16-20 UNF	7/16-20 UNF
PS690310-6-6	3.05" 77.4 mm	2.54" 64.4 mm	1.29" 32.8 mm	.88" 22.2 mm	9/16-18 UNF	9/16-18 UNF
PS890310-8-8	3.29" 83.7 mm	2.70" 68.7 mm	1.73" 44.0 mm	1.12" 28.6 mm	3/4-16 UNF	3/4-16 UNF
PS1290310-12-12	3.76" 95.6 mm	3.10" 78.8 mm	2.17" 55.2 mm	1.38" 35.0 mm	1-1/16-12 UN	1-1/16-12 UN
PS1690310-16-16	4.41" 112.0 mm	3.54" 90.0 mm	2.48" 63.0 mm	1.62" 41.3 mm	1-1/16-12 UN	1-1/16-12 UN

Male SAE O-Ring Straight Thread - Female Pipe

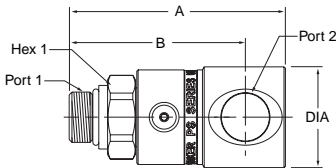

Part Number	A	B	Dia.	Hex 1	Port 1	Port 2
PS490502-4-4	2.70" 68.6 mm	2.29" 58.3 mm	1.20" 30.5 mm	.75" 19.0 mm	7/16-20 UNF	1/4-18 NPTF
PS690502-6-6	2.87" 72.8 mm	2.36" 59.8 mm	1.29" 32.8 mm	.88" 22.2 mm	9/16-18 UNF	3/8-18 NPTF
PS890502-8-8	3.19" 80.9 mm	2.60" 65.9 mm	1.49" 37.8 mm	1.12" 28.6 mm	3/4-16 UNF	1/2-14 NPTF
PS1290502-12-12	3.58" 90.9 mm	2.92" 74.0 mm	1.76" 44.6 mm	1.38" 35.0 mm	1-1/16-12 UN	3/4-14 NPTF
PS1690502-16-16	4.18" 106.3 mm	3.32" 84.3 mm	2.16" 54.9 mm	1.62" 41.3 mm	1-5/16-12 UN	1-11 1/2 NPTF

D Swivels

Male SAE O-Ring Straight Thread - Male 37° Flare

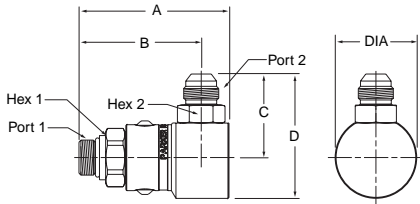

Part Number	A	B	C	D	Dia.	Hex 1	Hex 2	Port 1	Port 2
PS490503-4-4	2.70" 68.6 mm	2.29" 58.3 mm	1.39" 35.2 mm	1.99" 50.5 mm	1.20" 30.5 mm	.75" 19.0 mm	.56" 14.3 mm	7/16-20 UNF	7/16-20 UNF
PS690503-6-6	2.87" 72.8 mm	2.36" 59.8 mm	1.44" 36.6 mm	2.09" 53.0 mm	1.29" 32.8 mm	.88" 22.2 mm	.69" 17.5 mm	9/16-18 UNF	9/16-18 UNF
PS890503-8-8	3.19" 80.9 mm	2.60" 65.9 mm	1.78" 45.1 mm	2.64" 67.1 mm	1.73" 44.0 mm	1.12" 28.6 mm	.88" 22.2 mm	3/4-16 UNF	3/4-16 UNF
PS890503-10-10	3.25" 82.5 mm	2.66" 67.5 mm	1.90" 48.4 mm	2.77" 70.4 mm	1.73" 44.0 mm	1.12" 28.6 mm	.88" 22.2 mm	7/8-14 UNF	7/8-14 UNF
PS1290503-12-12	3.58" 90.9 mm	2.92" 74.0 mm	2.24" 56.9 mm	3.86" 85.3 mm	2.17" 55.2 mm	1.38" 35.0 mm	1.25" 31.8 mm	1-1/16-12 UN	1-1/16-12 UN
PS1690503-16-16	4.18" 106.3 mm	3.32" 84.3 mm	2.42" 61.3 mm	3.66" 92.9 mm	2.48" 63.0 mm	1.62" 41.3 mm	1.50" 38.1 mm	1-5/16-12 UN	1-5/16-12 UN

Male SAE O-Ring Straight Thread - Male SAE O-Ring Straight Thread

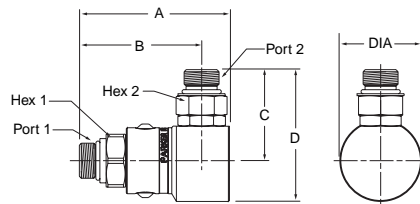

Part Number	A	B	C	D	Dia.	Hex 1	Hex 2	Port 1	Port 2
PS490505-4-4	2.70" 68.6 mm	2.29" 58.3 mm	1.38" 35.0 mm	1.98" 50.2 mm	1.20" 30.5 mm	.75" 19.0 mm	.56" 14.3 mm	7/16-20 UNF	7/16-20 UNF
PS690505-6-6	2.87" 72.8 mm	2.36" 59.8 mm	1.55" 39.4 mm	2.20" 55.8 mm	1.29" 32.8 mm	.88" 22.2 mm	.69" 17.5 mm	9/16-18 UNF	9/16-18 UNF
PS890505-8-8	3.19" 80.9 mm	2.60" 65.9 mm	1.86" 47.2 mm	2.72" 69.2 mm	1.73" 44.0 mm	1.12" 28.6 mm	.88" 22.2 mm	3/4-16 UNF	3/4-16 UNF
PS1290505-12-12	3.58" 90.9 mm	2.92" 74.0 mm	2.40" 61.0 mm	3.49" 88.5 mm	2.17" 55.2 mm	1.38" 35.0 mm	1.25" 31.8 mm	1-1/16-12 UN	1-1/16-12 UN
PS1690505-16-16	4.18" 106.3 mm	3.32" 84.3 mm	2.50" 63.4 mm	3.74" 94.9 mm	2.48" 63.0 mm	1.62" 41.3 mm	1.50" 38.1 mm	1-5/16-12 UN	1-5/16-12 UN

Male SAE O-Ring Straight Thread - Female 37° Flare

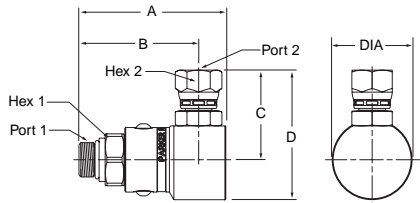

Part Number	A	B	C	D	Dia.	Hex 1	Hex 2	Port 1	Port 2
PS490506-4-4	2.70" 68.6 mm	2.29" 58.3 mm	1.47" 37.3 mm	2.07" 52.5 mm	1.20" 30.5 mm	.75" 19.0 mm	.56" 14.3 mm	7/16-20 UNF	7/16-20 UNF
PS690506-6-6	2.87" 72.8 mm	2.36" 59.8 mm	1.57" 39.9 mm	2.22" 56.3 mm	1.29" 32.8 mm	.88" 22.2 mm	.69" 17.5 mm	9/16-18 UNF	9/16-18 UNF
PS890506-8-8	3.19" 80.9 mm	2.60" 65.9 mm	1.91" 48.4 mm	2.77" 70.4 mm	1.73" 44.0 mm	1.12" 28.6 mm	.88" 22.2 mm	3/4-16 UNF	3/4-16 UNF
PS1290506-12-12	3.58" 90.9 mm	2.92" 74.0 mm	2.34" 59.4 mm	3.43" 87.0 mm	2.17" 55.2 mm	1.38" 35.0 mm	1.25" 31.8 mm	1-1/16-12 UN	1-1/16-12 UN
PS1690506-16-16	4.18" 106.3 mm	3.32" 84.3 mm	2.54" 64.6 mm	3.79" 96.2 mm	2.48" 63.0 mm	1.62" 41.3 mm	1.50" 38.1 mm	1-5/16-12 UN	1-5/16-12 UN

Male SAE O-Ring Straight Thread - Female NPSM Pipe Swivel

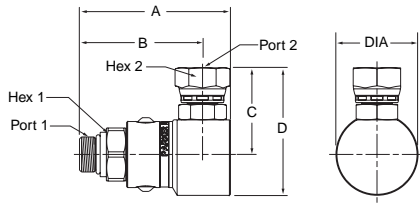

Part Number	A	B	C	D	Dia.	Hex 1	Hex 2	Port 1	Port 2
PS490507-4-4	2.70" 68.6 mm	2.29" 58.3 mm	1.48" 37.5 mm	2.08" 52.8 mm	1.20" 30.5 mm	.75" 19.0 mm	.69" 17.4 mm	7/16-20 UNF	1/4-18 NPSM
PS690507-6-6	2.87" 72.8 mm	2.36" 59.8 mm	1.51" 38.4 mm	2.16" 54.8 mm	1.29" 32.8 mm	.88" 22.2 mm	.88" 22.2 mm	9/16-18 UNF	3/8-18 NPSM
PS890507-8-8	3.19" 80.9 mm	2.60" 65.9 mm	1.86" 47.2 mm	2.72" 69.2 mm	1.73" 44.0 mm	1.12" 28.6 mm	1.00" 25.4 mm	3/4-16 UNF	1/2-14 NPSM
PS1290507-12-12	3.58" 90.9 mm	2.92" 74.0 mm	2.24" 56.9 mm	3.33" 84.5 mm	2.17" 55.2 mm	1.38" 35.0 mm	1.25" 31.8 mm	1-1/16-12 UN	3/4-14 NPSM
PS1690507-16-16	4.18" 106.3 mm	3.32" 84.3 mm	2.48" 63.1 mm	3.73" 94.6 mm	2.48" 63.0 mm	1.62" 41.3 mm	1.50" 38.1 mm	1-5/16-12 UN	1-11/2 NPSM

D Swivels

Male SAE O-Ring Straight Thread - Female SAE Straight Thread

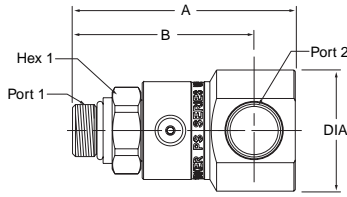

Part Number	A	B	Dia.	Hex 1	Port 1	Port 2
PS490510-4-4	2.70" 68.6 mm	2.29" 58.3 mm	1.20" 30.5 mm	.75" 19.0 mm	7/16-20 UNF	7/16-20 UNF
PS690510-6-6	2.87" 72.8 mm	2.36" 59.8 mm	1.29" 32.8 mm	.88" 22.2 mm	9/16-18 UNF	9/16-18 UNF
PS890510-8-8	3.19" 80.9 mm	2.60" 65.9 mm	1.73" 44.0 mm	1.12" 28.6 mm	3/4-16 UNF	3/4-16 UNF
PS1290510-12-12	3.58" 90.9 mm	2.92" 74.0 mm	2.17" 55.2 mm	1.38" 35.0 mm	1-1/16-12 UN	1-1/16-12 UN
PS1690510-16-16	4.18" 106.3 mm	3.32" 84.3 mm	2.48" 63.0 mm	1.62" 41.3 mm	1-5/16-12 UN	1-5/16-12 UN

Female SAE Straight Thread - Female Pipe

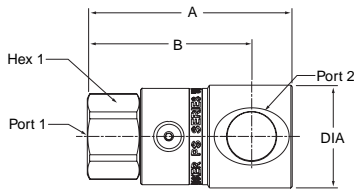

Part Number	A	B	Dia.	Hex 1	Port 1	Port 2
PS491002-4-4	2.42" 61.4 mm	2.01" 51.2 mm	1.20" 30.5 mm	.75" 19.0 mm	7/16-20 UNF	1/4-18 NPTF
PS691002-6-6	2.68" 68.2 mm	2.17" 55.2 mm	1.29" 32.8 mm	.88" 22.2 mm	9/16-18 UNF	3/8-18 NPTF
PS891002-8-8	2.96" 75.3 mm	2.37" 60.3 mm	1.49" 37.8 mm	1.12" 28.6 mm	3/4-16 UNF	1/2-14 NPTF
PS1291002-12-12	3.43" 87.2 mm	2.77" 70.4 mm	1.76" 44.6 mm	1.38" 35.0 mm	1-1/16-12 UN	3/4-14 NPTF
PS1691002-16-16	4.03" 102.3 mm	3.16" 80.3 mm	2.16" 54.9 mm	1.62" 41.3 mm	1-5/16-12 UN	1-11/2 NPTF

Female SAE Straight Thread - Male 37° Flare

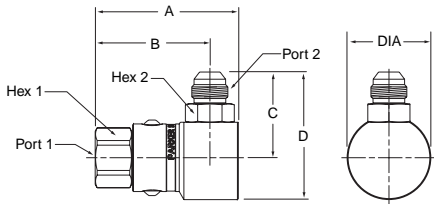

Part Number	A	B	C	D	Dia.	Hex 1	Hex 2	Port 1	Port 2
PS491003-4-4	2.42" 61.4 mm	2.01" 51.2 mm	1.39" 35.2 mm	1.99" 50.5 mm	1.20" 30.5 mm	.75" 19.0 mm	.56" 14.3 mm	7/16-20 UNF	7/16-20 UNF
PS691003-6-6	2.68" 68.2 mm	2.17" 55.2 mm	1.44" 36.6 mm	2.09" 53.0 mm	1.29" 32.8 mm	.88" 22.2 mm	.69" 17.5 mm	9/16-18 UNF	9/16-18 UNF
PS891003-8-8	2.96" 75.3 mm	2.37" 60.3 mm	1.78" 45.1 mm	2.64" 67.1 mm	1.73" 44.0 mm	1.12" 28.6 mm	.88" 22.2 mm	3/4-16 UNF	3/4-16 UNF
PS1291003-12-12	3.43" 87.2 mm	2.77" 70.4 mm	2.24" 56.9 mm	3.86" 98.3 mm	2.17" 55.2 mm	1.38" 35.0 mm	1.25" 31.8 mm	1-1/16-12 UN	1-1/16-12 UN
PS1691003-16-16	4.03" 102.3 mm	3.16" 80.3 mm	2.42" 61.3 mm	3.66" 92.9 mm	2.48" 63.0 mm	1.62" 41.3 mm	1.50" 38.1 mm	1-5/16-12 UN	1-5/16-12 UN

Female SAE Straight Thread - Male SAE O-Ring Straight Thread

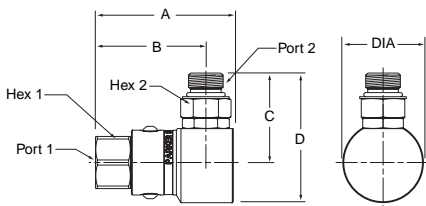

Part Number	A	B	C	D	Dia.	Hex 1	Hex 2	Port 1	Port 2
PS491005-4-4	2.42" 61.4 mm	2.01" 51.2 mm	1.38" 35.0 mm	1.98" 50.2 mm	1.20" 30.5 mm	.75" 19.0 mm	.56" 14.3 mm	7/16-20 UNF	7/16-20 UNF
PS691005-6-6	2.68" 68.2 mm	2.17" 55.2 mm	1.55" 39.4 mm	2.20" 55.8 mm	1.29" 32.8 mm	.88" 22.2 mm	.69" 17.5 mm	9/16-18 UNF	9/16-18 UNF
PS891005-8-8	2.96" 75.3 mm	2.37" 60.3 mm	1.86" 47.2 mm	2.72" 69.2 mm	1.73" 44.0 mm	1.12" 28.6 mm	.88" 22.2 mm	3/4-16 UNF	3/4-16 UNF
PS1291005-12-12	3.43" 87.2 mm	2.77" 70.4 mm	2.40" 61.0 mm	3.49" 88.5 mm	2.17" 55.2 mm	1.38" 35.0 mm	1.25" 31.8 mm	1-1/16-12 UN	1-1/16-12 UN
PS1691005-16-16	4.03" 102.3 mm	3.16" 80.3 mm	2.50" 63.4 mm	3.74" 94.9 mm	2.48" 63.0 mm	1.62" 41.3 mm	1.50" 38.1 mm	1-5/16-12 UN	1-5/16-12 UN

D Swivels

Female SAE Straight Thread - Female 37° Flare

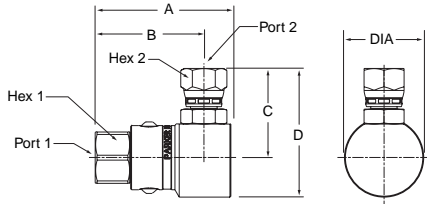

Part Number	A	B	C	D	Dia.	Hex 1	Hex 2	Port 1	Port 2
PS491006-4-4	2.42" 61.4 mm	2.01" 51.2 mm	1.47" 37.3 mm	2.07" 52.6 mm	1.20" 30.5 mm	.75" 19.0 mm	.56" 14.3 mm	7/16-20 UNF	7/16-20 UNF
PS691006-6-6	2.68" 68.2 mm	2.17" 55.2 mm	1.57" 39.9 mm	2.22" 56.3 mm	1.29" 32.8 mm	.88" 22.2 mm	.69" 17.5 mm	9/16-18 UNF	9/16-18 UNF
PS891006-8-8	2.96" 75.3 mm	2.37" 60.3 mm	1.91" 48.4 mm	2.77" 70.4 mm	1.73" 44.0 mm	1.12" 28.6 mm	.88" 22.2 mm	3/4-16 UNF	3/4-16 UNF
PS1291006-12-12	3.43" 87.2 mm	2.77" 70.4 mm	2.34" 59.4 mm	3.43" 87.0 mm	2.17" 55.2 mm	1.38" 35.0 mm	1.25" 31.8 mm	1-1/16-12 UN	1-1/16-12 UN
PS1691006-16-16	4.03" 102.3 mm	3.16" 80.3 mm	2.54" 64.6 mm	3.79" 96.2 mm	2.48" 63.0 mm	1.62" 41.3 mm	1.50" 38.1 mm	1-5/16-12 UN	1-5/16-12 UN

Female SAE Straight Thread - Female NPSM Pipe Swivel

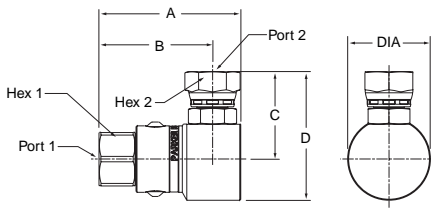

Part Number	A	B	C	D	Dia.	Hex 1	Hex 2	Port 1	Port 2
PS491007-4-4	2.42" 61.4 mm	2.01" 51.2 mm	1.48" 37.5 mm	2.08" 52.8 mm	1.20" 30.5 mm	.75" 19.0 mm	.69" 17.4 mm	7/16-20 UNF	1/4-18 NPSM
PS691007-6-6	2.68" 68.2 mm	2.17" 55.2 mm	1.51" 38.4 mm	2.16" 54.8 mm	1.29" 32.8 mm	.88" 22.2 mm	.88" 22.2 mm	9/16-18 UNF	3/8-18 NPSM
PS891007-8-8	2.96" 75.3 mm	2.37" 60.3 mm	1.86" 47.2 mm	2.72" 69.2 mm	1.73" 44.0 mm	1.12" 28.6 mm	1.00" 25.4 mm	3/4-16 UNF	1/2-14 NPSM
PS1291007-12-12	3.43" 87.2 mm	2.77" 70.4 mm	2.24" 56.9 mm	3.33" 84.5 mm	2.17" 55.2 mm	1.38" 35.0 mm	1.25" 31.8 mm	1-1/16-12 UN	3/4-14 NPSM
PS1691007-16-16	4.03" 102.3 mm	3.16" 80.3 mm	2.48" 63.1 mm	3.73" 94.6 mm	2.48" 63.0 mm	1.62" 41.3 mm	1.50" 38.1 mm	1-5/16-12 UN	1-11/2 NPSM

Female SAE Straight Thread - Female SAE Straight Thread

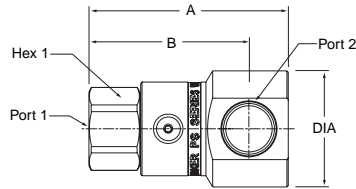

Part Number	A	B	Dia.	Hex 1	Port 1	Port 2
PS491010-4-4	2.42" 61.4 mm	2.01" 51.2 mm	1.20" 30.5 mm	.75" 19.0 mm	7/16-20 UNF	7/16-20 UNF
PS691010-6-6	2.68" 68.2 mm	2.17" 55.2 mm	1.29" 32.8 mm	.88" 22.2 mm	9/16-18 UNF	9/16-18 UNF
PS891010-8-8	2.96" 75.3 mm	2.37" 60.3 mm	1.73" 44.0 mm	1.12" 28.6 mm	3/4-16 UNF	3/4-16 UNF
PS1291010-12-12	3.43" 87.2 mm	2.77" 70.4 mm	2.17" 55.2 mm	1.38" 35.0 mm	1-1/16-12 UN	1-1/16-12 UN
PS1691010-16-16	4.03" 102.3 mm	3.16" 80.3 mm	2.48" 63.0 mm	1.62" 41.3 mm	1-5/16-12 UN	1-5/16-12 UN

3 Piece Design

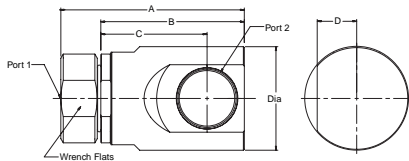

Part Number	A	B	C	D	Wrench Flats	Dia.	Port 1	Port 2
PS2491010-20-20	5.91" 150.2 mm	4.63" 117.5 mm	3.43" 87.0 mm	1.27" 32.3 mm	2.63" 66.7 mm	3.36" 85.2 mm	1 5/8-12 UN	1 5/8-12 UN
PS2491010-24-24	5.91" 150.2 mm	4.63" 117.5 mm	3.43" 87.0 mm	1.27" 32.3 mm	2.63" 66.7 mm	3.36" 85.2 mm	1 7/8-12 UN	1 7/8-12 UN
PS3291010-32-32	6.83" 173.8 mm	5.45" 138.4 mm	3.93" 99.7 mm	1.52" 38.5 mm	3.06" 77.6 mm	4.19" 106.4 mm	2 11/2 UN	2-1/2-12 UN

D Swivels

Repair Kits

Swivels

Repair Kits/Seal Options

Repair Kits come complete with O-Rings, PTFE Back-Up Ring, Cap Screws, Locking Balls, Retaining Ring and grease fitting. Repair kits are suitable for both current and previous design 90° PS Series Swivels.

1/4" Swivel	3/8" Swivel	1/2" Swivel	3/4" Swivel	1" Swivel
PS4-RPR	PS6-RPR	PS8-RPR	PS12-RPR	PS16-RPR
PS4Y-RPR	PS6Y-RPR	PS8Y-RPR	PS12Y-RPR	PS16Y-RPR
PS4A-RPR	PS6A-RPR	PS8A-RPR	PS12A-RPR	PS16A-RPR
PS4W-RPR	PS6W-RPR	PS8W-RPR	PS12W-RPR	PS16W-RPR

H2C-PS = Bearing Removal Pneumatic Nipple

Seal Options

Nitrile (*standard unless otherwise designated*)

A = Aflas™

W = Ethylene Propylene

Y = Fluorocarbon

Z = Neoprene

For **Perfluoroelastomer** seal option contact the division.

S Series Swivels

Introduction

The S Series Swivel product line complements the Quick Coupling Division's PS Series swivel line by offering a pressure balanced, compact forged body design. As a result of the pressure balanced design, the S Series Swivel does not experience a significant increase in torque as pressure rises. The housing body is forged to provide superior performance and durability in tough applications. This product is great for eliminating hose twist, torque and stress caused by the movement of the hydraulic components where side load to the swivel can be minimized.



Features

- 3000 psi working pressure rating for all sizes.
- Variety of seal options.
- Torque value does not significantly increase with pressure.
- Dust seals protect the swivel from damaging environmental contaminants.
- Field service kits are available for quick and reliable repairs.
- 360° swivel eliminates long radius bends, hose twist and stress that can cause premature hose failure.
- One piece forged housing eliminates a brazed 90° adapter connection.
- Case hardened for enhanced service life.
- Compact design to fit into tight areas.

Specifications

Body size	1/4"	3/8"	1/2"	3/4"	1"
Maximum Rated Pressure (PSI)	3000	3000	3000	3000	3000*
Temperature Range (standard seals)	-40° to 250° F				
Maximum RPM	10	10	10	10	10

* 07 ports on 1" S Series maximum rated pressure is 2600 psi.

Performance Data

**S Series Swivel (1/4", 3/8", 1/2", 3/4", 1")
Test Fluid: Oil - 150 SUS vs. Pressure Drop**

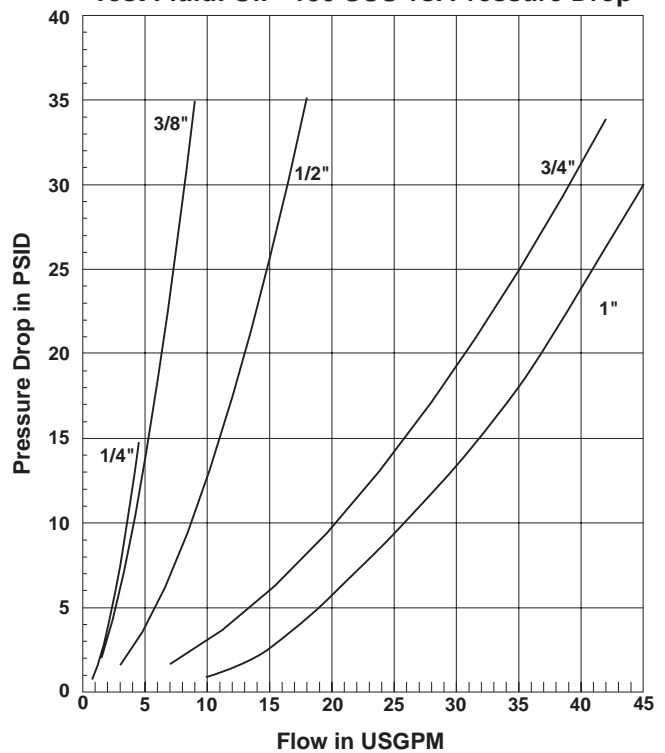

D Swivels

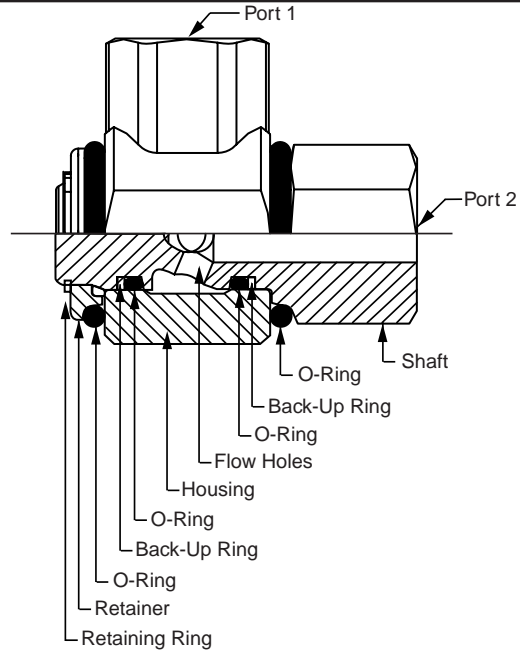

S Part Number:

S 21 02 V - 8 - 8 NI

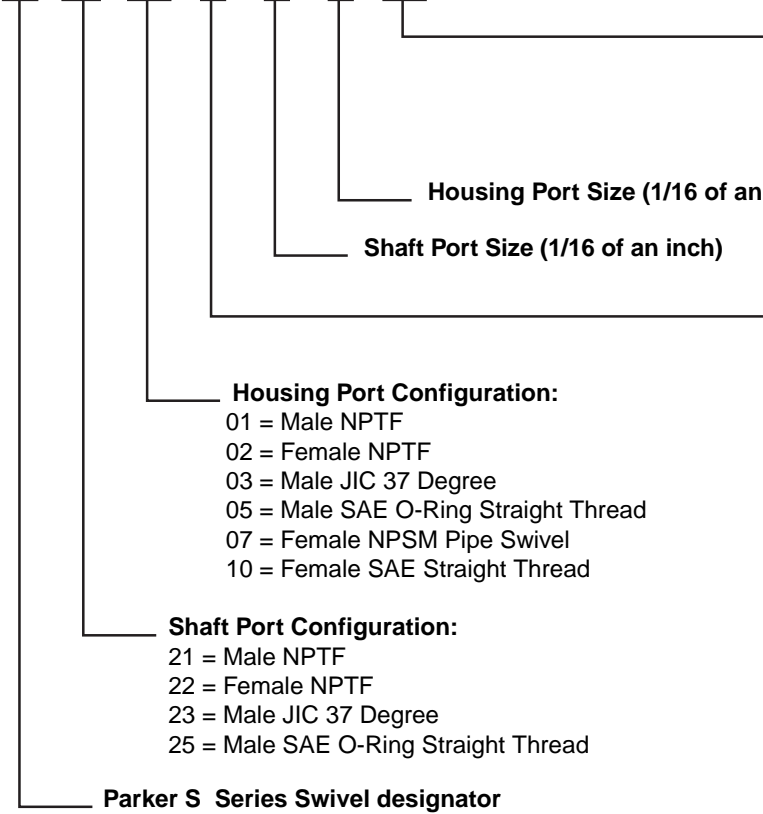

Material and Finish:

Blank = Carbon Steel (12L14)
w/Chromium-6 Free Plating
NI = Carbon Steel (12L14)*
Nickel Plating

Housing Port Size (1/16 of an inch)

Shaft Port Size (1/16 of an inch)

Seal Code:

Blank = Nitrile (Standard)
E = Ethylene Propylene
V = Fluorocarbon

Housing Port Configuration:

- 01 = Male NPTF
- 02 = Female NPTF
- 03 = Male JIC 37 Degree
- 05 = Male SAE O-Ring Straight Thread
- 07 = Female NPSM Pipe Swivel
- 10 = Female SAE Straight Thread

Shaft Port Configuration:

- 21 = Male NPTF
- 22 = Female NPTF
- 23 = Male JIC 37 Degree
- 25 = Male SAE O-Ring Straight Thread

Parker S Series Swivel designator

* Contact the Division for Price and Availability

Male Pipe - Male Pipe

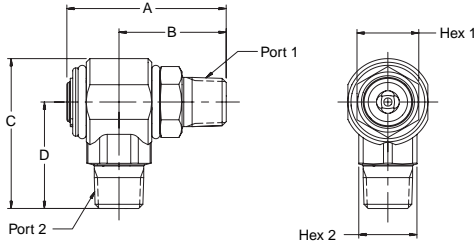

Part Number	A	B	C	D	HEX 1	HEX 2	PORT 1	PORT 2
S2101-4-4	2.31" 58.7 mm	1.51" 38.4 mm	2.19" 55.5 mm	1.50" 38.0 mm	.88" 22.2 mm	.88" 22.2 mm	1/4-18 NPTF	1/4-18 NPTF
S2101-6-6	2.31" 58.7 mm	1.51" 38.4 mm	2.19" 55.5 mm	1.50" 38.0 mm	.88" 22.2 mm	.88" 22.2 mm	3/8-18 NPTF	3/8-18 NPTF
S2101-8-8	2.74" 69.6 mm	1.84" 46.8 mm	2.59" 65.8 mm	1.84" 46.7 mm	1.06" 27.0 mm	1.00" 25.4 mm	1/2-14 NPTF	1/2-14 NPTF
S2101-12-12	3.35" 85.1 mm	2.12" 53.9 mm	3.00" 76.2 mm	2.11" 53.5 mm	1.38" 34.9 mm	1.38" 34.9 mm	3/4-14 NPTF	3/4-14 NPTF

Male Pipe - Female Pipe

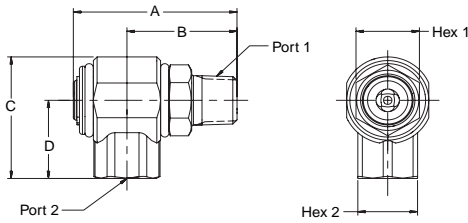

Part Number	A	B	C	D	HEX 1	HEX 2	PORT 1	PORT 2
S2102-4-4	2.31" 58.7 mm	1.51" 38.4 mm	1.78" 45.1 mm	1.09" 27.6 mm	.88" 22.2 mm	.88" 22.2 mm	1/4-18 NPTF	1/4-18 NPTF
S2102-6-6	2.31" 58.7 mm	1.51" 38.4 mm	1.78" 45.1 mm	1.09" 27.6 mm	.88" 22.2 mm	.88" 22.2 mm	3/8-18 NPTF	3/8-18 NPTF
S2102-8-8	2.74" 69.6 mm	1.84" 46.8 mm	2.10" 53.3 mm	1.35" 34.3 mm	1.06" 27.0 mm	1.00" 25.4 mm	1/2-14 NPTF	1/2-14 NPTF
S2102-12-12	3.35" 85.1 mm	2.12" 53.9 mm	2.39" 60.7 mm	1.50" 38.0 mm	1.38" 34.9 mm	1.38" 34.9 mm	3/4-14 NPTF	3/4-14 NPTF

Male Pipe - Male 37° Flare

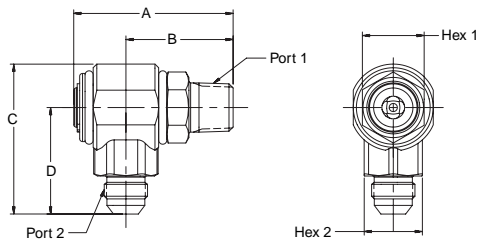

Part Number	A	B	C	D	HEX 1	HEX 2	PORT 1	PORT 2
S2103-4-4	2.31" 58.7 mm	1.51" 38.4 mm	2.19" 55.5 mm	1.50" 38.0 mm	.88" 22.2 mm	.88" 22.2 mm	1/4-18 NPTF	7/16-20UNF
S2103-6-6	2.31" 58.7 mm	1.51" 38.4 mm	2.19" 55.5 mm	1.50" 38.0 mm	.88" 22.2 mm	.88" 22.2 mm	3/8-18 NPTF	9/16-18UNF
S2103-8-8	2.74" 69.6 mm	1.84" 46.8 mm	2.59" 65.8 mm	1.84" 46.7 mm	1.06" 27.0 mm	1.00" 25.4 mm	1/2-14 NPTF	3/4-16UNF
S2103-12-12	3.35" 85.1 mm	2.12" 53.9 mm	3.07" 77.9 mm	2.17" 55.2 mm	1.38" 34.9 mm	1.38" 34.9 mm	3/4-14 NPTF	1-1/16-12UN
S2103-16-16	3.95" 100.33 mm	2.54" 64.5 mm	3.01" 76.5 mm	2.11" 53.6 mm	1.63" 41.4 mm	1.69" 42.9 mm	1-11 1/2 NPTF	1-5/16-12UN

Male Pipe - Female NPSM Pipe Swivel

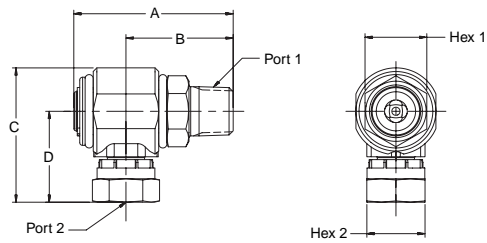

Part Number	A	B	C	D	HEX 1	HEX 2	PORT 1	PORT 2
S2107-4-4	2.31" 58.7 mm	1.51" 38.4 mm	2.05" 52.0 mm	1.36" 34.5 mm	.88" 22.2 mm	.69" 17.5 mm	1/4-18 NPTF	1/4-18 NPSM
S2107-6-6	2.31" 58.7 mm	1.51" 38.4 mm	2.07" 52.5 mm	1.38" 35.1 mm	.88" 22.2 mm	.88" 22.2 mm	3/8-18 NPTF	3/8-18 NPSM
S2107-8-8	2.74" 69.6 mm	1.84" 46.8 mm	2.32" 59.0 mm	1.57" 39.9 mm	1.06" 27.0 mm	1.00" 25.4 mm	1/2-14 NPTF	1/2-14 NPSM
S2107-12-12	3.35" 85.1 mm	2.12" 53.9 mm	2.74" 69.5 mm	1.85" 46.9 mm	1.38" 34.9 mm	1.25" 31.8 mm	3/4-14 NPTF	3/4-14 NPSM
S2107-16-16	3.95" 100.3 mm	2.54" 64.5 mm	3.14" 79.8 mm	2.23" 56.6 mm	1.63" 41.4 mm	1.69" 42.9 mm	1-11 1/2 NPTF	1-11 1/2 NPSM

Male Pipe - Female SAE Straight Thread

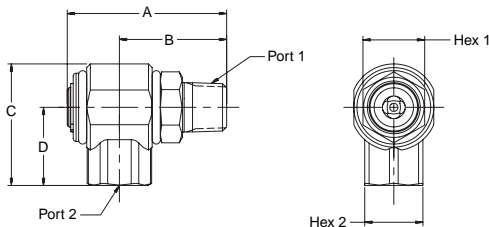

Part Number	A	B	C	D	HEX 1	HEX 2	PORT 1	PORT 2
S2110-6-6	2.31" 58.7 mm	1.51" 38.4 mm	1.78" 45.1 mm	1.09" 27.6 mm	.88" 22.2 mm	.88" 22.2 mm	3/8-18 NPTF	9/16-18UNF
S2110-8-8	2.74" 69.6 mm	1.84" 46.8 mm	2.10" 53.3 mm	1.35" 34.3 mm	1.06" 27.0 mm	1.00" 25.4 mm	1/2-14 NPTF	3/4-16UNF
S2110-12-12	3.35" 85.1 mm	2.12" 53.9 mm	2.54" 64.5 mm	1.65" 41.9 mm	1.38" 34.9 mm	1.38" 34.9 mm	3/4-14 NPTF	1-1/16-12UN

Female Pipe - Male Pipe

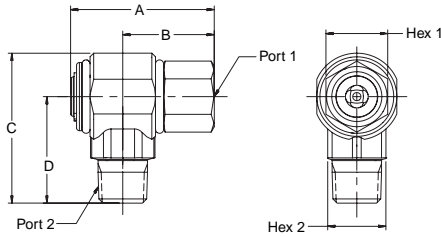

Part Number	A	B	C	D	HEX 1	HEX 2	PORT 1	PORT 2
S2201-4-4	2.19" 55.6 mm	1.39" 35.4 mm	2.19" 55.5 mm	1.50" 38.0 mm	.88" 22.2 mm	.88" 22.2 mm	1/4-18 NPTF	1/4-18 NPTF
S2201-6-6	2.19" 55.6 mm	1.39" 35.4 mm	2.19" 55.5 mm	1.50" 38.0 mm	.88" 22.2 mm	.88" 22.2 mm	3/8-18 NPTF	3/8-18 NPTF
S2201-8-8	2.47" 62.7 mm	1.57" 40.0 mm	2.59" 65.8 mm	1.84" 46.7 mm	1.06" 27.0 mm	1.00" 25.4 mm	1/2-14 NPTF	1/2-14 NPTF
S2201-12-12	3.15" 80.0 mm	1.92" 48.8 mm	3.00" 76.2 mm	2.11" 53.5 mm	1.38" 34.9 mm	1.38" 34.9 mm	3/4-14 NPTF	3/4-14 NPTF

Female Pipe - Female Pipe

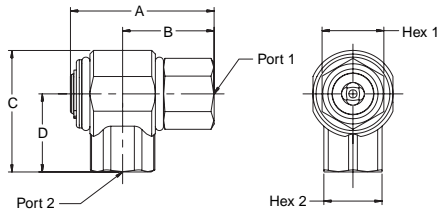

Part Number	A	B	C	D	HEX 1	HEX 2	PORT 1	PORT 2
S2202-4-4	2.19" 55.6 mm	1.39" 35.4 mm	1.78" 45.1 mm	1.09" 27.6 mm	.88" 22.2 mm	.88" 22.2 mm	1/4-18 NPTF	1/4-18 NPTF
S2202-6-6	2.19" 55.6 mm	1.39" 35.4 mm	1.78" 45.1 mm	1.09" 27.6 mm	.88" 22.2 mm	.88" 22.2 mm	3/8-18 NPTF	3/8-18 NPTF
S2202-8-8	2.47" 62.7 mm	1.57" 40.0 mm	2.10" 53.3 mm	1.35" 34.3 mm	1.06" 27.0 mm	1.00" 25.4 mm	1/2-14 NPTF	1/2-14 NPTF
S2202-12-12	3.15" 80.0 mm	1.92" 48.8 mm	2.39" 60.7 mm	1.50" 38.0 mm	1.38" 34.9 mm	1.38" 34.9 mm	3/4-14 NPTF	3/4-14 NPTF

Female Pipe - Male 37° Flare

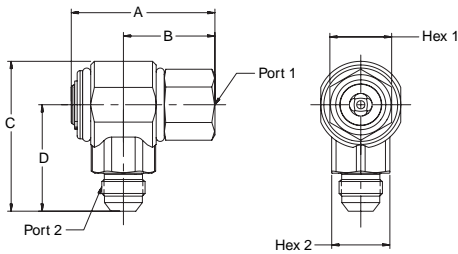

Part Number	A	B	C	D	HEX 1	HEX 2	PORT 1	PORT 2
S2203-4-4	2.19" 55.6 mm	1.39" 35.4 mm	2.19" 55.5 mm	1.50" 38.0 mm	.88" 22.2 mm	.88" 22.2 mm	1/4-18 NPTF	7/16-20UNF
S2203-6-6	2.19" 55.6 mm	1.39" 35.4 mm	2.19" 55.5 mm	1.50" 38.0 mm	.88" 22.2 mm	.88" 22.2 mm	3/8-18 NPTF	9/16-18UNF
S2203-8-8	2.47" 62.7 mm	1.57" 40.0 mm	2.59" 65.8 mm	1.84" 46.7 mm	1.06" 27.0 mm	1.00" 25.4 mm	1/2-14 NPTF	3/4-16UNF
S2203-12-12	3.15" 80.0 mm	1.92" 48.8 mm	3.07" 77.9 mm	2.17" 55.2 mm	1.38" 34.9 mm	1.38" 34.9 mm	3/4-14 NPTF	1-1/16-12UN
S2203-16-16	3.55" 90.2 mm	2.13" 54.1 mm	3.01" 76.5 mm	2.11" 53.6 mm	1.63" 41.4 mm	1.69" 42.9 mm	1-11 1/2 NPTF	1-5/16-12UN

Female Pipe - Female SAE Straight Thread

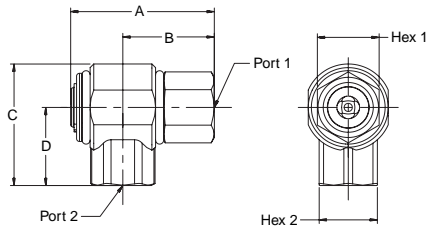

Part Number	A	B	C	D	HEX 1	HEX 2	PORT 1	PORT 2
S2210-6-6	2.19" 55.6 mm	1.39" 35.4 mm	1.78" 45.1 mm	1.09" 27.6 mm	.88" 22.2 mm	.88" 22.2 mm	3/8-18 NPTF	9/16-18UNF
S2210-8-8	2.47" 62.7 mm	1.57" 40.0 mm	2.10" 53.3 mm	1.35" 34.3 mm	1.06" 27.0 mm	1.00" 25.4 mm	1/2-14 NPTF	3/4-16UNF
S2210-12-12	3.15" 80.0 mm	1.92" 48.8 mm	2.54" 64.5 mm	1.65" 41.9 mm	1.38" 34.9 mm	1.38" 34.9 mm	3/4-14 NPTF	1-1/16-12UN

Female Pipe - Female NPSM Pipe Swivel

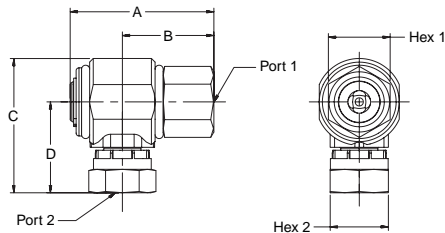

Part Number	A	B	C	D	HEX 1	HEX 2	PORT 1	PORT 2
S2207-4-4	2.19" 55.6 mm	1.39" 35.4 mm	2.05" 52.0 mm	1.36" 34.5 mm	.88" 22.2 mm	.69" 17.5 mm	1/4-18 NPTF	1/4-18 NPSM
S2207-6-6	2.19" 55.6 mm	1.39" 35.4 mm	2.07" 52.5 mm	1.38" 35.1 mm	.88" 22.2 mm	.88" 22.2 mm	3/8-18 NPTF	3/8-18 NPSM
S2207-8-8	2.47" 62.7 mm	1.57" 40.0 mm	2.32" 59.0 mm	1.57" 39.9 mm	1.06" 27.0 mm	1.00" 25.4 mm	1/2-14 NPTF	1/2-14 NPSM
S2207-12-12	3.15" 80.0 mm	1.92" 48.8 mm	2.74" 69.5 mm	1.85" 46.9 mm	1.38" 34.9 mm	1.25" 31.8 mm	3/4-14 NPTF	3/4-14 NPSM
S2207-16-16	3.55" 90.2 mm	2.13" 54.1 mm	3.14" 79.8 mm	2.23" 56.6 mm	1.63" 41.4 mm	1.69" 42.9 mm	1-11 1/2 NPTF	1-11 1/2 NPSM

Male 37° Flare - Male Pipe

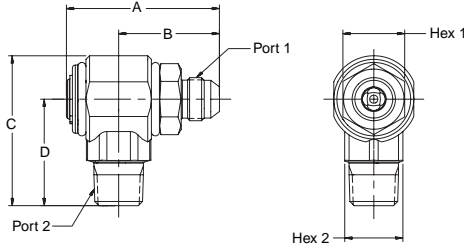

Part Number	A	B	C	D	HEX 1	HEX 2	PORT 1	PORT 2
S2301-4-4	2.41" 61.2 mm	1.61" 40.9 mm	2.19" 55.5 mm	1.50" 38.0 mm	.88" 22.2 mm	.88" 22.2 mm	7/16-20UNF	1/4-18 NPTF
S2301-6-6	2.41" 61.2 mm	1.61" 40.9 mm	2.19" 55.5 mm	1.50" 38.0 mm	.88" 22.2 mm	.88" 22.2 mm	9/16-18UNF	3/8-18 NPTF
S2301-8-8	2.63" 66.8 mm	1.73" 44.0 mm	2.59" 65.8 mm	1.84" 46.7 mm	1.06" 27.0 mm	1.00" 25.4 mm	3/4-16UNF	1/2-14 NPTF
S2301-12-12	3.33" 84.6 mm	2.10" 53.4 mm	3.00" 76.2 mm	2.11" 53.5 mm	1.38" 34.9 mm	1.38" 34.9 mm	1-1/16-12UN	3/4-14 NPTF

Male 37° Flare - Female Pipe

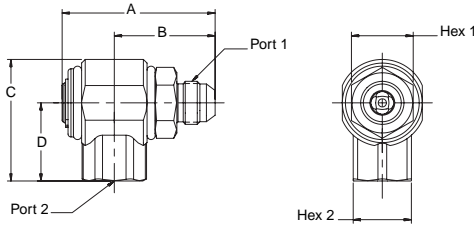

Part Number	A	B	C	D	HEX 1	HEX 2	PORT 1	PORT 2
S2302-4-4	2.41" 61.2 mm	1.61" 40.9 mm	1.78" 45.1 mm	1.09" 27.6 mm	.88" 22.2 mm	.88" 22.2 mm	7/16-20UNF	1/4-18 NPTF
S2302-6-6	2.41" 61.2 mm	1.61" 40.9 mm	1.78" 45.1 mm	1.09" 27.6 mm	.88" 22.2 mm	.88" 22.2 mm	9/16-18UNF	3/8-18 NPTF
S2302-8-8	2.63" 66.8 mm	1.73" 44.0 mm	2.10" 53.3 mm	1.35" 34.3 mm	1.06" 27.0 mm	1.00" 25.4 mm	3/4-16UNF	1/2-14 NPTF
S2302-12-12	3.33" 84.6 mm	2.10" 53.4 mm	2.39" 60.7 mm	1.50" 38.0 mm	1.38" 34.9 mm	1.38" 34.9 mm	1-1/16-12UN	3/4-14 NPTF

Male 37° Flare - Male 37° Flare

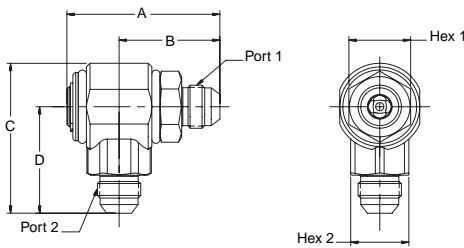

Part Number	A	B	C	D	HEX 1	HEX 2	PORT 1	PORT 2
S2303-4-4	2.41" 61.2 mm	1.61" 40.9 mm	2.19" 55.5 mm	1.50" 38.0 mm	.88" 22.2 mm	.88" 22.2 mm	7/16-20UNF	7/16-20UNF
S2303-6-6	2.41" 61.2 mm	1.61" 40.9 mm	2.19" 55.5 mm	1.50" 38.0 mm	.88" 22.2 mm	.88" 22.2 mm	9/16-18UNF	9/16-18UNF
S2303-8-8	2.63" 66.8 mm	1.73" 44.0 mm	2.59" 65.8 mm	1.84" 46.7 mm	1.06" 27.0 mm	1.00" 25.4 mm	3/4-16UNF	3/4-16UNF
S2303-10-10	2.63" 66.8 mm	1.73" 44.0 mm	2.59" 65.8 mm	1.84" 46.7 mm	1.06" 27.0 mm	1.00" 25.4 mm	7/8-14UNF	7/8-14UNF
S2303-12-12	3.33" 84.6 mm	2.10" 53.4 mm	3.07" 77.9 mm	2.17" 55.2 mm	1.38" 34.9 mm	1.38" 34.9 mm	1-1/16-12UN	1-1/16-12UN
S2303-16-16	4.05" 102.9 mm	2.64" 67.1 mm	3.01" 76.5 mm	2.11" 53.6 mm	1.63" 41.4 mm	1.69" 42.9 mm	1-5/16-12UN	1-5/16-12UN

Male 37° Flare - Female NPSM Pipe Swivel

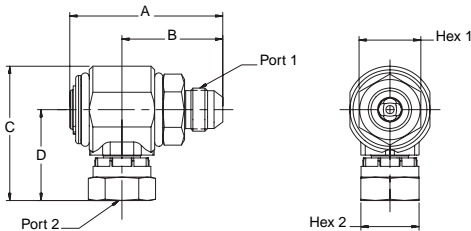

Part Number	A	B	C	D	HEX 1	HEX 2	PORT 1	PORT 2
S2307-4-4	2.41" 61.2 mm	1.61" 40.9 mm	2.05" 52.0 mm	1.36" 34.5 mm	.88" 22.2 mm	.69" 17.5 mm	7/16-20UNF	1/4-18 NPSM
S2307-6-6	2.41" 61.2 mm	1.61" 40.9 mm	2.07" 52.5 mm	1.38" 35.1 mm	.88" 22.2 mm	.88" 22.2 mm	9/16-18UNF	3/8-18 NPSM
S2307-8-8	2.63" 66.8 mm	1.73" 44.0 mm	2.32" 59.0 mm	1.57" 39.9 mm	1.06" 27.0 mm	1.00" 25.4 mm	3/4-16UNF	1/2-14 NPSM
S2307-12-12	3.33" 84.6 mm	2.10" 53.4 mm	2.74" 69.5 mm	1.85" 46.9 mm	1.38" 34.9 mm	1.25" 31.8 mm	1-1/16-12UN	3/4-14 NPSM

Male 37° Flare - Female SAE Straight Thread

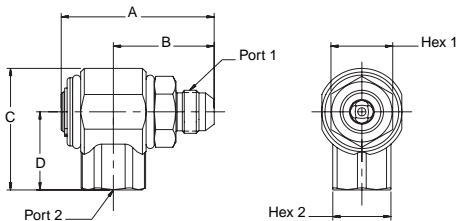

Part number	A	B	C	D	HEX 1	HEX 2	PORT 1	PORT 2
S2310-6-6	2.41" 61.2 mm	1.61" 40.9 mm	1.78" 45.1 mm	1.09" 27.6 mm	.88" 22.2 mm	.88" 22.2 mm	9/16-18UNF	9/16-18UNF
S2310-8-8	2.63" 66.8 mm	1.73" 44.0 mm	2.10" 53.3 mm	1.35" 34.3 mm	1.06" 27.0 mm	1.00" 25.4 mm	3/4-16UNF	3/4-16UNF
S2310-12-12	3.33" 84.6 mm	2.10" 53.4 mm	2.54" 64.5 mm	1.65" 41.9 mm	1.38" 34.9 mm	1.38" 34.9 mm	1-1/16-12UN	1-1/16-12UN

Male SAE O-Ring Straight Thread - Male Pipe

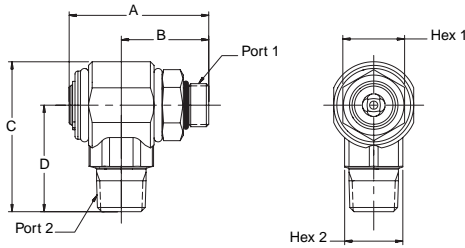

Part number	A	B	C	D	HEX 1	HEX 2	PORT 1	PORT 2
S2501-6-6	2.13" 54.1 mm	1.33" 33.8 mm	2.19" 55.5 mm	1.50" 38.0 mm	.88" 22.2 mm	.88" 22.2 mm	9/16-18UNF	3/8-18 NPTF
S2501-8-8	2.40" 61.0 mm	1.50" 38.2 mm	2.59" 65.8 mm	1.84" 46.7 mm	1.06" 27.0 mm	1.00" 25.4 mm	3/4-16UNF	1/2-14 NPTF
S2501-12-12	3.40" 86.4 mm	2.17" 55.2 mm	3.00" 76.2 mm	2.11" 53.5 mm	1.38" 34.9 mm	1.38" 34.9 mm	1-1/16-12UN	3/4-14 NPTF

Male SAE O-Ring Straight Thread - Female Pipe

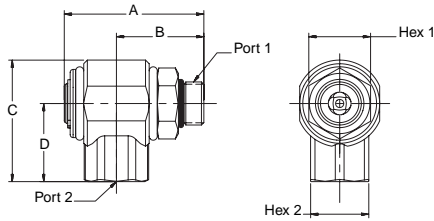

Part number	A	B	C	D	HEX 1	HEX 2	PORT 1	PORT 2
S2502-6-6	2.13" 54.1 mm	1.33" 33.8 mm	1.78" 45.1 mm	1.09" 27.6 mm	.88" 22.2 mm	.88" 22.2 mm	9/16-18UNF	3/8-18 NPTF
S2502-8-8	2.40" 61.0 mm	1.50" 38.2 mm	2.10" 53.3 mm	1.35" 34.3 mm	1.06" 27.0 mm	1.00" 25.4 mm	3/4-16UNF	1/2-14 NPTF
S2502-12-12	3.40" 86.4 mm	2.17" 55.2 mm	2.39" 60.7 mm	1.50" 38.0 mm	1.38" 34.9 mm	1.38" 34.9 mm	1-1/16-12UN	3/4-14 NPTF

Male SAE O-Ring Straight Thread - Male 37° Flare

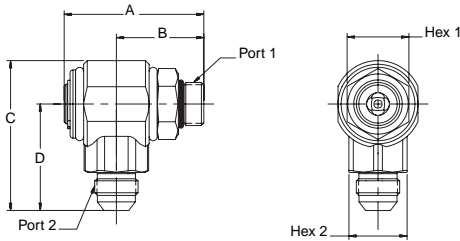

Part number	A	B	C	D	HEX 1	HEX 2	PORT 1	PORT 2
S2503-6-6	2.13" 54.1 mm	1.33" 33.8 mm	2.19" 55.5 mm	1.50" 38.0 mm	.88" 22.2 mm	.88" 22.2 mm	9/16-18UNF	9/16-18UNF
S2503-8-8	2.40" 61.0 mm	1.50" 38.2 mm	2.59" 65.8 mm	1.84" 46.7 mm	1.06" 27.0 mm	1.00" 25.4 mm	3/4-16UNF	3/4-16UNF
S2503-10-10	2.54" 64.5 mm	1.64" 41.7 mm	2.59" 65.8 mm	1.84" 46.7 mm	1.06" 27.0 mm	1.00" 25.4 mm	7/8-14UNF	7/8-14UNF
S2503-12-12	3.40" 86.4 mm	2.17" 55.2 mm	3.07" 77.9 mm	2.17" 55.2 mm	1.38" 34.9 mm	1.38" 34.9 mm	1-1/16-12UN	1-1/16-12UN
S2503-16-16	3.75" 95.3 mm	2.33" 59.2 mm	3.01" 76.5 mm	2.11" 53.6 mm	1.63" 41.4 mm	1.69" 42.9 mm	1-5/16-12UN	1-5/16-12UN

Male SAE O-Ring Straight Thread - Female NPSM Pipe Swivel

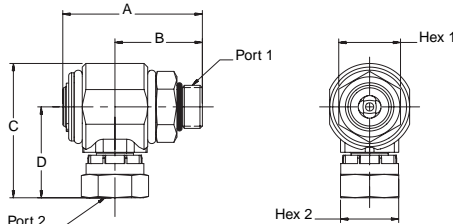

Part number	A	B	C	D	HEX 1	HEX 2	PORT 1	PORT 2
S2507-6-6	2.13" 54.1 mm	1.33" 33.8 mm	2.07" 52.5 mm	1.38" 35.1 mm	.88" 22.2 mm	.88" 22.2 mm	9/16-18UNF	3/8-18 NPSM
S2507-8-8	2.40" 61.0 mm	1.50" 38.2 mm	2.32" 59.0 mm	1.57" 39.9 mm	1.06" 27.0 mm	1.00" 25.4 mm	3/4-16UNF	1/2-14 NPSM
S2507-12-12	3.75" 86.4 mm	2.17" 55.2 mm	2.74" 69.5 mm	1.85" 46.9 mm	1.38" 34.9 mm	1.25" 31.8 mm	1-1/16-12UN	3/4-14 NPSM
S2507-16-16	3.75" 95.3 mm	2.33" 59.2 mm	3.14" 79.8 mm	2.23" 56.6 mm	1.63" 41.4 mm	1.69" 42.9 mm	1-5/16-12UN	1-11/2 NPSM

Male SAE O-Ring Straight Thread - Female SAE Straight Thread

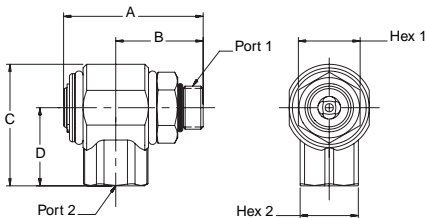

Part number	A	B	C	D	HEX 1	HEX 2	PORT 1	PORT 2
S2510-6-6	2.13" 54.1 mm	1.33" 33.8 mm	1.78" 45.1 mm	1.09" 27.6 mm	.88" 22.2 mm	.88" 22.2 mm	9/16-18UNF	9/16-18UNF
S2510-8-8	2.40" 61.0 mm	1.50" 38.2 mm	2.10" 53.3 mm	1.35" 34.3 mm	1.06" 27.0 mm	1.00" 25.4 mm	3/4-16UNF	3/4-16UNF
S2510-12-12	3.40" 86.4 mm	2.17" 55.2 mm	2.54" 64.5 mm	1.65" 41.9 mm	1.38" 34.9 mm	1.38" 34.9 mm	1-1/16-12UN	1-1/16-12UN

D Swivels

Swivels

Repair Kits/Seal Options

Repair Kits come complete with primary O-Rings, PTFE back-up rings, external and internal dust seals, retaining ring and instruction sheet.

Nitrile Seals		EP Seals		Fluorocarbon Seals	
Size	Kit Number	Size	Kit Number	Size	Kit Number
-4/-6	RK-4/6N	-4/-6	RK-4/6E	-4/-6	RK-4/6V
-8/-10	RK-8N	-8/-10	RK-8E	-8/-10	RK-8V
-12	RK-12N	-12	RK-12E	-12	RK-12V
-16	RK-16N	-16	RK-16E	-16	RK-16V

D Swivels