

# ***Hydraulic Quick Couplings***

### Hydraulic Quick Couplings

#### Double Shut-Off and Straight-Thru Couplings

Parker hydraulic couplings have a wide variety of designs, each tailored to a particular application or use. This catalog is arranged according to those categories. In each section the construction of a specific design will be detailed. However, based on the valving of the coupling, hydraulic couplings generally fall into one of two groups, either Double Shut-Off or Straight-Thru.

Double Shut-Off couplings are used extensively when it is important to minimize fluid loss upon disconnection. Both halves of the coupler, the body and the nipple, contain shut-

off valves. These valves open automatically when the body and nipple are connected, and close automatically when the two halves are disconnected—keeping fluid loss to a minimum.

Parker Straight-Thru couplings have no valves in either half and are ideal for maximum flow application. Their smooth, open bore offers the lowest pressure drop of any quick disconnect coupling, and allows them to be thoroughly cleaned. Since there are no valves in either half, fluid flow should be shut off before the coupling is disconnected.

#### Rated Pressure

Rated pressure for the Parker hydraulic couplings range from 30 to 15,000 psi, depending on the coupling series, size and materials. Rated pressures as shown in this catalog are defined by ISO 5598, as “the qualified operating pressures which are recommended for a component or a system by the manufacturer.” Parker “Rated Pressures” have been established on the basis of laboratory tests which include, but are not limited to, static burst tests and multiple cycle impulse tests. System characteristics such as high cycling rates and high amplitude shocks either hydraulic or mechanical, can reduce the functioning life of a coupling,

even if the system’s nominal pressure falls within the rated pressure range of the coupling.

For assistance in analyzing your application, contact your nearest Parker sales office or the Quick Coupling Division in Minneapolis.

Refer to the Safety Guide at the end of this catalog for considerations when selecting a Quick Coupling.

Refer to the Fluid Compatibility Chart (note Table of Contents) for seal selection assistance for both Double Shut-Off and Straight-Thru couplings.

#### Checklist for Selecting Quick Couplings

- What are the functional requirements of the coupling?
- What is the maximum working pressure of the application?
- Which seals and body material are compatible with the system’s fluid?
- Is the application static or dynamic?
- What size coupler is required?
- What is the maximum pressure drop suitable for the application?
- Does the application require the ability to connect and disconnect under pressure?
- What is the media temperature and ambient temperature?
- What end configurations are required?
- Is an industry interchange coupler required?
- Is air inclusion and fluid loss a concern in the application?

Hydraulic Quick Couplings



<b>Introduction</b> .....	<b>B-2</b>	FS Series .....	<b>B-31-32</b>
<b>Coupling Selection Guide</b> .....	<b>B-4</b>	Couplers .....	<b>B-32</b>
<b>General Purpose Couplings</b>		Nipples .....	<b>B-32</b>
60 Series .....	<b>B-5-8</b>	Repair Kits .....	<b>B-32</b>
Couplers .....	<b>B-7-8</b>	<b>Connect Under Pressure Couplings</b>	
Nipples .....	<b>B-7-8</b>	6100 Series .....	<b>B-33-35</b>
Repair Kits & Replacement Parts .....	<b>B-8</b>	Couplers .....	<b>B-34-35</b>
60 Series Steam .....	<b>B-9</b>	Nipples .....	<b>B-34-35</b>
Couplers .....	<b>B-9</b>	8200 Series .....	<b>B-36-37</b>
Nipples .....	<b>B-9</b>	Couplers .....	<b>B-37</b>
6600 Series .....	<b>B-10-11</b>	Nipples .....	<b>B-37</b>
Couplers .....	<b>B-11</b>	9200 Series .....	<b>B-38-39</b>
Nipples .....	<b>B-11</b>	Couplers .....	<b>B-39</b>
SM Series .....	<b>B-12-13</b>	Nipples .....	<b>B-39</b>
Couplers .....	<b>B-13</b>	5000 Series .....	<b>B-40-41</b>
Nipples .....	<b>B-13</b>	Couplers .....	<b>B-41</b>
HP Series .....	<b>B-14-15</b>	Nipples .....	<b>B-41</b>
Couplers .....	<b>B-15</b>	<b>High Pressure Couplings</b>	
Nipples .....	<b>B-15</b>	3000 Series .....	<b>B-42-43</b>
4000 Series .....	<b>B-16-17</b>	Couplers .....	<b>B-43</b>
Couplers .....	<b>B-17</b>	Nipples .....	<b>B-43</b>
Nipples .....	<b>B-17</b>	TC Series .....	<b>B-44</b>
4200 Series .....	<b>B-18-19</b>	Couplers .....	<b>B-44</b>
Couplers .....	<b>B-19</b>	Nipples .....	<b>B-44</b>
Nipples .....	<b>B-19</b>	1141 Series .....	<b>B-45</b>
<b>Non-Spill Couplings</b>		<b>Mold Coolant Line Couplings</b>	
NS Series .....	<b>B-20-21</b>	Moldmate Series .....	<b>B-46-50</b>
Couplers .....	<b>B-21</b>	Couplers .....	<b>B-47-48</b>
Nipples .....	<b>B-21</b>	Sub Assemblies & Replacement Parts .....	<b>B-48</b>
Adapters .....	<b>B-22</b>	Nipples .....	<b>B-49-50</b>
FF Series .....	<b>B-23-24</b>	<b>High Flow Couplings</b>	
Couplers .....	<b>B-24</b>	ST Series .....	<b>B-51-53</b>
Nipples .....	<b>B-24</b>	Couplers .....	<b>B-52</b>
FEM Series .....	<b>B-25-26</b>	Nipples .....	<b>B-53</b>
Couplers .....	<b>B-26</b>	Water Service .....	<b>B-54</b>
Nipples .....	<b>B-26</b>	HO Series .....	<b>B-55</b>
FC Series .....	<b>B-27</b>	<b>Special Purpose - Miniature</b>	
Nipples .....	<b>B-27</b>	DM Series .....	<b>B56-B57</b>
FEC Series .....	<b>B-28</b>	<b>Dust Plugs and Dust Caps</b> .....	<b>B-58-60</b>
Nipples .....	<b>B-28</b>	<b>Ordering Information</b> .....	<b>B-61</b>
FH Series .....	<b>B-29-30</b>	<b>Promotional Products-Keychains</b> .....	<b>B-62</b>
Couplers .....	<b>B-30</b>		
Nipples .....	<b>B-30</b>		

## Coupling Selection & Ordering Guide

### Hydraulic Quick Couplings

	Valving	Body Size	Material* Br S S3 S6	Locking Mechanism	Std. Seal Material**	Temp Range**	Rated Pressure	
<b>General Purpose</b>								
60 Series	Poppet	1/8 - 2 1/2"	● ● ● ●	Ball	Nitrile	-40° to +250° F	1000 to 5000 PSI	
60 Series Steam	Poppet	1/4 to 1"	●	Ball	Ethylene Propylene	-65° to +400° F		
6600 Series	Poppet	1/4 to 1"	●	Ball	Nitrile	-40° to +250° F	4000 to 5000 PSI	
SM Series	Poppet	1/4 to 3/4"	●	Ball	Nitrile	-40° to +250° F	4500 to 6000 PSI	
HP Series	Poppet	1 to 1 1/2"	●	Ball	Nitrile	-40° to +250° F	5000 PSI	
4000 Series	Poppet/Ball	1/4 to 1"	●	Ball	Nitrile	-40° to +250° F	3000 PSI	
4200 Series	Poppet/Ball	3/8 to 1/2"	●	Ball	Nitrile	-40° to +250° F	3000 PSI	
<b>Non-Spill</b>								
NS Series	Flush Face	3/8 to 1"	●	Ball	Nitrile	-40° to +250° F	2500 PSI	
Adapter	Flush Face/Poppet	1/2"	●	Ball	Nitrile/Polyurathane	-40° to +250° F	3000 to 3625 PSI	
FF Series	Flush Face	1/4 to 1"	●	Ball	Nitrile/Polyurathane	-40° to +250° F	3000 to 5000 PSI	
FEM Series	Flush Face	1/4 to 1"	●	Ball	Nitrile/Polyurathane	-40° to +250° F	3000 to 5000 PSI	
FS Series	Flush Face	1/4 to 1"		●	Ball	Fluorocarbon	-15° to +400° F	2000 PSI
<b>Non-Spill Connect Under Pressure</b>								
FC Series	Flush Face	3/8 to 3/4"	●	Ball	Nitrile/Polyurathane	-40° to +250° F	3000 PSI	
FEC Series	Flush Face	1/2 to 3/4"	●	Ball	Nitrile/Polyurathane	-40° to +250° F	3000 PSI	
6100 Series	Flush Face	3/4 to 1 1/2"	●	Threads	Nitrile	-40° to +250° F	2000 to 3000 PSI	
<b>Connect Under Pressure</b>								
8200 Series	Poppet	1/2"	●	Ball	Nitrile	-40° to +250° F	3000 PSI	
9200 Series	Poppet	1/2"	●	Ball	Nitrile	-40° to +250° F	3000 PSI	
5000 Series	Ball	1/2"	●	Threads	Nitrile	-40° to +250° F	2500 PSI	
<b>High Pressure</b>								
FH Series	Flush Face	3/8"	●	Ball	Nitrile	-40° to +250° F	10,000 PSI	
3000 Series	Ball	1/4 to 3/8"	●	Threads	Polyurethane	-22° to +230° F	10,000 PSI	
TC Series	Poppet	3/8"	●	Ball	Fluorocarbon	-15° to +400° F	10,000 PSI	
1141 Series	Poppet	1/4"		●	Threads	Polyurethane	-40° to +180° F	10,000 PSI
<b>Mold Coolant</b>								
Moldmate	Valved & Unvalved	1/4 to 1/2"	●	Ball	Silicone	-20° to +400° F	200 PSI	
<b>High Flow</b>								
ST Series	Unvalved	1/8 to 1 1/2"	● ● ●	Ball	Nitrile	-40° to +250° F	2500 to 6700 PSI	
HO Series	Unvalved	1/4 to 1/2"	●	Ball	Nitrile	-40° to +250° F	10,000 to 15,000 PSI	
Water Service	Unvalved	3/4"	●	Ball	Nitrile	-40° to +250° F	200 PSI	
<b>Special Purpose - Miniature</b>								
DM Series	Poppet	1/8	●	Ball	Fluorocarbon	-15° to +400° F	250 PSI	

See Fluid Compatibility chart and/or consult factory for questions regarding proper material for specific applications.

\* Material Code: Br = Brass; S = Steel; S3 = 303 Stainless Steel; S6 = 316 Stainless Steel

**\*\*Optional Seals Seal Material Specific Coupling Series Using Optional Seal Suffix Designator at left**

W	Ethylene Propylene	60, 6600, 4000, 4200, 6100, 5000, 8200, 9200, ST
Y	Fluorocarbon	60, 6600, 4000, 4200, 6100, 5000, 8200, 9200, ST, Moldmate (if used with oil based media only)
Z	Neoprene	60, 6600, 4000, 4200, 6100, 5000, 8200, 9200, ST
E5	Ethylene Propylene	SM, HP, NS, FF, FEM, FH, FS, HO
E4	Fluorocarbon	SM, HP, NS, FF, FEM, FH, FS (STD-no suffix needed), HO, TC (Fluorocarbon only-no suffix needed)
E12	Neoprene	SM, HP, NS, FF, FEM, FH, FS, HO
E47	Perfluoroelastomer	SM, HP, NS, FF, FEM, FH, FS (Contact the division re: Perfluoroelastomer options) 3000 and 1141 with Polyurethane only (no suffix needed) Water Service (Nitrile only)

To select proper Seal Materials, see Fluid Compatibility chart in Appendices, or contact your Parker Quick Coupling Distributor.





**Applications**

Parker general purpose couplings, are used across the spectrum of hydraulic applications. These Double Shut-Off couplings can be found anywhere that fluid transfer lines need to be connected and disconnected for operation or maintenance of equipment, and a loss of fluid is undesirable. Primarily used with hydraulic fluid, general purpose Double Shut-Off couplings are also used with chemicals, water, steam, and some gases.

**Special Order Information**

60 Series couplings are available in Chromium-6 Free plated steel, brass, 303 stainless steel, and 316 stainless steel. Brass couplings have double O-Ring seals and stainless locking balls.

Standard seal material is Nitrile; optional seal materials are available.

For 316 stainless steel products, standard seal material is Fluorocarbon, and other seal materials are available upon request. See Fluid Compatibility Chart at end of this catalog.

All sizes of 60 Series can be furnished with locking sleeves. Place suffix letters “-SL” (Sleeve-Lok) after regular catalog numbers. Example H3-62-SL. Parker 60 Series heavy duty nipples are recommended where high cycle rates and pressure surges are encountered. Machined from high tensile steel and induction hardened, they are Chromium-6 Free plated. To specify a heavy duty nipple, add the prefix “HD” to the steel part number; thus: HD-H2-63.

**Note**

Protective dust plugs and caps play a crucial role in the life of a quick coupling and no purchase of a hydraulic quick coupling is complete without the selection of an appropriate dust plug and cap. See pages noted in Table of Contents for dust plugs and caps for the Parker full line of hydraulic couplings.

**Specifications**

<b>Industry Standard:</b> Parker 60 Series couplings comply with ISO 7241 Series B Standard.																
<b>ANSI/ISO Pressure Rating:</b> Dynamic applications with normal to moderate hydraulic shocks such as general industrial equipment, hydraulic presses, agricultural equipment, etc. Impulse tested at a multiple (125% to 133%) of rated pressure.									<b>Low Cycle, Non-pulsating Pressure Rating:</b> Applications with lower cycle life and no severe cyclic pressure fluctuations, essentially steady pressure during an operating cycle. Typical applications include hydraulic jacks, mine roof support systems, and high pressure fluid transfer (pumping water or slurry in oil wells). Minor pump ripple is considered non-pulsating. Impulse tested at rated pressure.							
<b>Body Size (in.)</b>	1/8	1/4	3/8	1/2	3/4	1	1 1/2	2 1/2	1/8	1/4	3/8	1/2	3/4	1	1 1/2	2 1/2
	Rated Pressure (PSI)								Rated Pressure (PSI)							
Brass	1000	1000	1000	1000	1000	1000	800	800	3000	3700	2700	3500	2200	1500	1500	1200
Stainless steel	2000	2000	1500	1500	1500	1000	1000	1000	5000	5000	5000	5000	3000	3000	1500	1500
Steel	5000	5000	4000	4000	2500	2000	1000	1000	5000	5000	4000	4000	2500	2000	1500	1500
Steel w / HD nipple	N/A	5000	4000	4000	3000	3000	N/A	N/A	5000	5000	4000	4000	3000	3000	N/A	N/A
Seal Temperature Range: Nitrile: -40°F to +250°F (Standard seal for Brass, Steel, & 303 Stainless Steel couplings). Fluorocarbon: -15°F to +400°F (Standard seal for 316 Stainless Steel couplings). Other Seal materials: Contact the Division for availability.																
Vacuum Data: 27.4 inches Hg. both connected and disconnected (1-1/2" and 2-1/2" body size 60 Series couplings are not recommended for service in disconnected mode)																
<b>Note:</b> Read the Safety Guide for Selecting and Using Quick Action Couplings and Related Accessories before making a coupling selection. It may be found in Parker Hannifin Quick Coupling Division catalogs and is available as Parker Publication No. 3800-B1.0.																

<b>Body Size (in.)</b>	1/8	1/4	3/8	1/2	3/4	1	1 1/2	2 1/2
Rated Flow (GPM)	.8	3	6	12	28	50	100	200

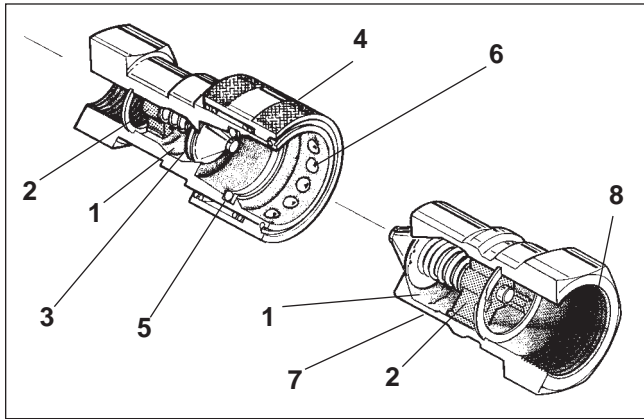

### Features

1. Large flow areas machined into the body of the coupler and nipple facilitate flow around the valve, for a high flow capacity.
2. Positive valve stop. The perch maintains valve alignment and provides metal to metal valve stop to ensure that the valves open fully, every time.
3. Captive valve seal assures "bubble tight" poppet sealing. The valve seal is positively captured by the metal poppet to minimize seal washout or damage from high velocity fluid.
4. Hardened nipples and sleeves (steel) and solid barstock construction make for a quality coupling with maximum resistance to damage from hydraulic and mechanical shock.
5. The seal is designed to withstand high pressures and provide reliable sealing. A wide selection of optional seal materials are available, see Fluid Compatibility Chart at end of this catalog for selection assistance. Steel versions feature PTFE back-up rings that support mating seals for high pressure applications. Brass couplers have a double O-ring seal for redundancy in low pressure, vacuum and steam applications.
6. Durable ball-locking mechanism assures reliable connection, every time. A large number of locking balls distributes the work load evenly while providing alignment and swiveling action to reduce hose torque and prolong hose life.
7. Manufactured from brass, steel and stainless steel as standard materials. A wide range of seals allow these couplings to be used with a broad range of media.
8. Also available with a Straight Thread (ORB) end configuration available as standard.
9. Industrial Standard: Parker 60 Series couplings comply with ISO 7241, Series B Standard.

### Performance

60 Series (1/8" & 1/4")  
Test Fluid: Oil - 150 SUS

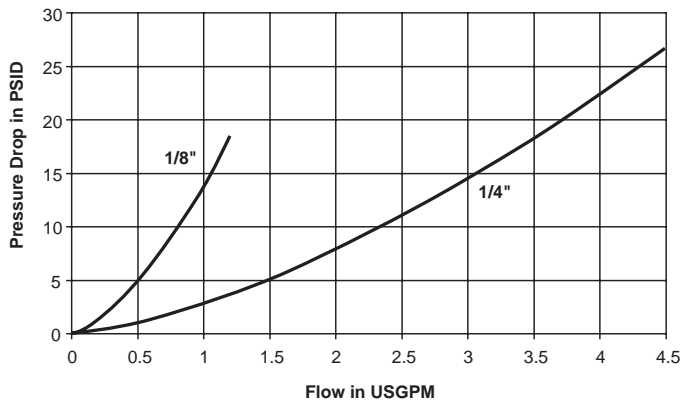

60 Series (3/8" & 1/2")  
Test Fluid: Oil - 150 SUS

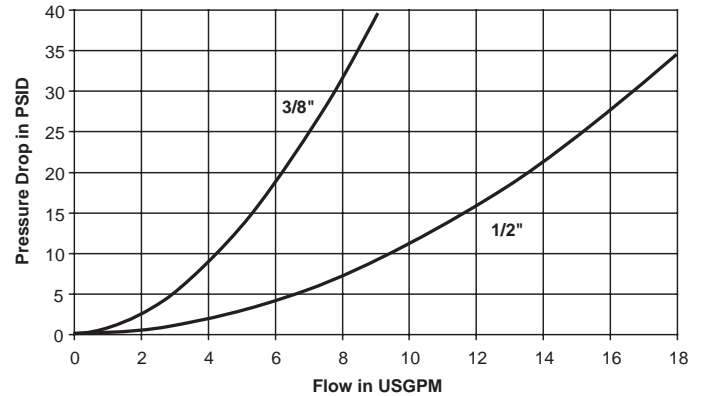

60 Series (3/4" & 1")  
Test Fluid: Oil - 150 SUS

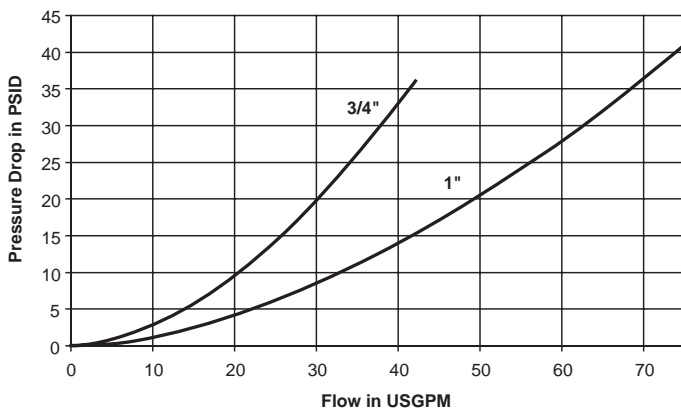

60 Series (1-1/2" & 2-1/2")  
Test Fluid: Oil - 200 SUS

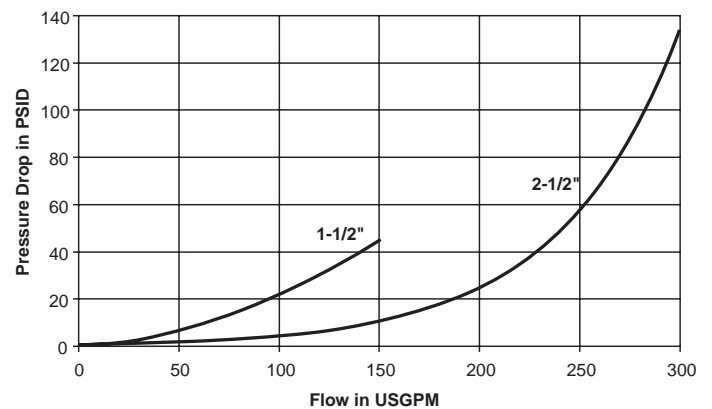

# Hydraulic Quick Couplings

# General Purpose Couplings 60 Series

## Couplers

### Female Thread

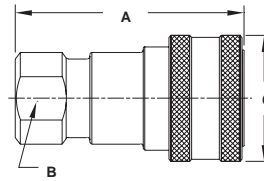

Body Size (in.)	Part No. Brass	Wt. (LB.) P/Piece	Part No. Steel	Wt. (LB.) P/Piece	Part No. Type 303 Stainless	Wt. (LB.) P/Piece	Part No. Type 316 Stainless	Wt. (LB.) P/Piece	Thread Size NPTF	Thread Size ORB	Dimensions (in.)			
											Overall Length	Wrench Flats	Largest Diameter	
												A	B	C
1/8	BH1-60	0.16	H1-62	0.16	SH1-62	0.16	SSH1-62Y	0.15	1/8-27	-	1.90	0.68	0.96	
1/8	-	-	H1-62-T4	0.18	SH1-62-T4	0.10	SSH1-62Y-T4	0.17	-	7/16-20	2.06	0.68	0.96	
1/4	BH2-60	0.32	H2-62	0.30	SH2-62	0.30	SSH2-62Y	0.30	1/4-18	-	2.26	0.81	1.14	
1/4	-	-	H2-62-T6	0.31	SH2-62-T6	0.31	SSH2-62Y-T6	0.31	-	9/16-18	2.41	0.81	1.14	
3/8	BH3-60	0.43	H3-62	0.40	SH3-62	0.40	SSH3-62Y	0.40	3/8-18	-	2.49	0.88	1.40	
3/8	-	-	H3-62-T8	0.51	SH3-62-T8	0.51	SSH3-62Y-T8	0.51	-	3/4-16	2.75	1.00	1.40	
1/2	BH4-60	0.80	H4-62	0.73	SH4-62	0.75	SSH4-62Y	0.76	1/2-14	-	2.87	1.12	1.77	
1/2	-	-	H4-62-T10	0.78	SH4-62-T10	0.75	SSH4-62Y-T10	0.78	-	7/8-14	3.05	1.12	1.77	
3/4	BH6-60	-	H6-62	1.30	SH6-62	1.31	SSH6-62Y	1.33	3/4-14	-	3.56	1.31	2.14	
3/4	-	-	H6-62-T12	1.39	SH6-62-T12	1.34	SSH6-62Y-T12	1.40	-	1-1/16-12	3.56	1.31	2.14	
1	BH8-60	-	H8-62	1.95	SH8-62	1.95	SSH8-62Y	1.95	1-11 1/2	-	4.18	1.62	2.52	
1	-	-	H8-62-T16	1.95	SH8-62-T16	1.95	SSH8-62Y-T16	1.95	-	1-5/16-12	4.18	1.62	2.52	

## Nipples

### Female Thread

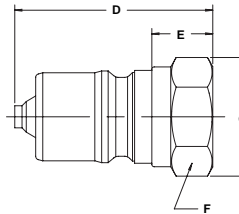

Body Size (in.)	Part No. Brass	Wt. (LB.) P/Piece	Part No. Steel	Wt. (LB.) P/Piece	Part No. Type 303 Stainless	Wt. (LB.) P/Piece	Part No. Type 316 Stainless	Wt. (LB.) P/Piece	Thread Size NPTF	Thread Size ORB	Dimensions (in.)				
											Overall Length	Exposed Length*	Wrench Flats	Largest Diameter	
												D	E	F	G
1/8	BH1-61	0.04	H1-63	0.03	SH1-63	0.03	SSH1-63Y	0.04	1/8-27	-	1.26	0.44	0.56	0.65	
1/8	-	0.06	H1-63-T4	0.05	SH1-63-T4	-	SSH1-63Y-T4	0.06	-	7/16-20	1.41	0.59	0.69	0.79	
1/4	BH2-61	0.09	H2-63	0.08	SH2-63	0.08	SSH2-63Y	0.08	1/4-18	-	1.54	0.55	0.75	0.87	
1/4	-	0.11	H2-63-T6	0.10	SH2-63-T6	0.10	SSH2-63Y-T6	0.10	-	9/16-18	1.69	0.70	0.88	1.01	
3/8	BH3-61	0.10	H3-63	0.12	SH3-63	0.12	SSH3-63Y	0.12	3/8-18	-	1.68	0.54	0.88	1.01	
3/8	-	0.12	H3-63-T8	0.16	SH3-63-T8	0.16	SSH3-63Y-T8	0.14	-	3/4-16	1.94	0.80	1.00	1.15	
1/2	BH4-61	0.25	H4-63	0.24	SH4-63	0.24	SSH4-63Y	0.24	1/2-14	-	1.94	0.69	1.12	1.30	
1/2	-	0.28	H4-63-T10	0.27	SH4-63-T10	0.27	SSH4-63Y-T10	0.27	-	7/8-14	2.12	0.87	1.19	1.37	
3/4	BH6-61	0.50	H6-63	0.46	SH6-63	0.45	SSH6-63Y	0.46	3/4-14	-	2.43	0.79	1.38	1.59	
3/4	-	0.55	H6-63-T12	0.46	SH6-63-T12	0.50	SSH6-63Y-T12	0.50	-	1-1/16-12	2.54	0.90	1.34	1.59	
1	BH8-61	0.76	H8-63	0.76	SH8-63	0.76	SSH8-63Y	0.76	1-11 1/2	-	2.91	0.99	1.62	1.88	
1	-	0.80	H8-63-T16	0.80	SH8-63-T16	0.80	SSH8-63Y-T16	0.80	-	1-5/16-12	2.91	0.99	1.62	1.88*	

\* This dimension represents the portion that is exposed when the nipple is inserted into the mating Parker Coupler.

## Optional Seals

### 60 Series



Optional Seals Suffix	
W	Ethylene Propylene (EPR)
Y	Fluorocarbon
Z	Neoprene
	Perfluoroelastomer (Contact factory for Seal options)



# Hydraulic Quick Couplings

# General Purpose Couplings 60 Series

## Couplers

### Female Thread

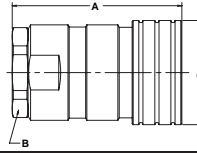

Body Size (in.)	Part No. Brass	Wt. (LB.) P/Piece	Part No. Steel	Wt. (LB.) P/Piece	Part No. Type 303 Stainless	Wt. (LB.) P/Piece	Part No. Type 316 Stainless	Wt. (LB.) P/Piece	Thread Size NPTF	Thread Size ORB	Dimensions (in.)		
											Overall Length	Wrench Flats	Largest Diameter
											A	B	C
1 1/2	BH12-60L	4.58	H12-62L	4.70	SH12-62L	4.68	SSH12-62LY	4.68	1 1/4-11 1/2	-	4.86	2.38 <sup>‡</sup>	3.00
1 1/2	BH12-60N	4.58	H12-62N	4.70	SH12-62N	4.68	SSH12-62NY	4.68	1 1/2-11 1/2	-	4.86	2.38 <sup>‡</sup>	3.00
1 1/2	-	4.61	H12-62-T20	4.72	SH12-62-T20	4.71	SSH12-62Y-T20	4.71	-	1 5/8-12	4.86	2.38 <sup>‡</sup>	3.00
1 1/2	-	4.61	H12-62-T24	4.72	SH12-62-T24	4.71	SSH12-62Y-T24	4.71	-	1 7/8-12	4.86	2.38 <sup>‡</sup>	3.00
2 1/2	BH2016-60	11.06	H2016-62	10.58	SH2016-62	-	SSH2016-62Y	-	2-11 1/2	-	5.57	3.75	4.10
2 1/2	BH2020-60	11.42	H2020-62	10.91	SH2020-62	-	SSH2020-62Y	-	2 1/2-8	-	6.04	3.75	4.10
2 1/2	BH2024-60	-	H2024-62	-	SH2024-62	-	SSH2024-62Y	-	3-8	-	6.96	4.00	4.35

‡Wrench Flat on 303 Stainless is 2.50 in.

## Nipples

### Female Thread

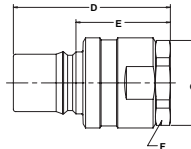

Body Size (in.)	Part No. Brass	Wt. (LB.) P/Piece	Part No. Steel	Wt. (LB.) P/Piece	Part No. Type 303 Stainless	Wt. (LB.) P/Piece	Part No. Type 316 Stainless	Wt. (LB.) P/Piece	Thread Size NPTF	Thread Size ORB	Dimensions (in.)			
											Overall Length	Exposed Length*	Wrench Flats	Largest Diameter
											D	E	F	G
1 1/2	BH12-61L	2.96	H12-63L	3.10	SH12-63L	3.06	SSH12-63LY	-	1 1/4-11 1/2	-	4.76	2.69	2.38 <sup>‡</sup>	2.75 <sup>†</sup>
1 1/2	BH12-61N	2.96	H12-63N	3.10	SH12-63N	3.06	SSH12-63NY	-	1 1/2-11 1/2	-	4.76	2.69	2.38 <sup>‡</sup>	2.75 <sup>†</sup>
1 1/2	-	-	H12-63-T20	3.15	SH12-63-T20	3.14	SSH12-63Y-T20	-	-	1 5/8-12	4.76	2.69	2.38 <sup>‡</sup>	2.75 <sup>†</sup>
1 1/2	-	-	H12-63-T24	3.15	SH12-63-T24	3.14	SSH12-63Y-T24	-	-	1 7/8-12	4.76	2.69	2.38 <sup>‡</sup>	2.75 <sup>†</sup>
2 1/2	BH2016-61	7.78	H2016-63	7.90	SH2016-63	7.92	SSH2016-63Y	-	2-11 1/2	-	5.48	2.90	3.75	4.10
2 1/2	BH2020-61	8.12	H2020-63	8.16	SH2020-63	8.16	SSH2020-63Y	-	2 1/2-8	-	5.95	3.37	3.75	4.10
2 1/2	BH2024-61	-	H2024-63	-	SH2024-63	-	SSH2024-63Y	-	3-8	-	6.87	4.29	4.00	4.35

\* This dimension represents the portion that is exposed when the nipple is inserted into the mating Parker Coupler.

† Largest diameter on Brass is 2.96" across Hex Corners

‡ Hex on 303 Stainless is 2.50 in.

## Replacement Parts

### 60 Series Couplers

Body Size (in.)	O-Rings - Nitrile	Back-Up Rings
1/8	50001-013-0010	H67A-28
1/4	50001-015-0010	H67C-28
3/8	50001-116-0010	4118007
1/2	50001-213-0010	4128002
3/4	50001-218-0010	4148001
1	50001-222-0010	4158001
1-1/2	50001-124-0010 (Valve)	
	50001-138-0260 (Fitting)	
	50001-224-0010 (Body 2 req.)	
2-1/2	50001-133-0010 (Valve)	
	50001-234-0260 (Fitting)	
	50001-333-0010 (Body)	

## Repair Kits

### Couplers

### Nipples

Body Size (in.)	Repair Kit Part No.	Used For Part No.	Repair Kit Part No.	Used For Part No.
3/8	H67E-62K	H3-62	H67E-63K	H3-63
	BH67E-60K	BH3-60	BH67E-61K	BH3-61
	SH67E-62K	SH3-62	SH67E-63K	SH3-63
	SSH67-62KY	SSH3-62Y	SSH67E-63KY	SSH3-63Y
1/2	H67F-62K	H4-62	H67F-63K	H4-63
	BH67F-60K	BH4-60	BH67F-61K	BH4-61
	SH67F-62K	SH4-62	SH67F-63K	SH4-63
	SSH67F-62KY	SSH4-62Y	SSH67F-63KY	SSH4-63Y
3/4	H67G-62K	H6-62	H67G-63K	H6-63
	BH67G-60K	BH6-60	BH67G-61K	BH6-61
	SH67G-62K	SH6-62	SH67G-63K	SH6-63
	SSH67G-62KY	SSH6-62Y	SSH67G-63KY	SSH6-63Y
1	H67J-62K	H8-62	H67J-63K	H8-63
	BH67J-60K	BH8-60	BH67J-61K	BH8-61
	SH67J-62K	SH8-62	SH67J-63K	SH8-63
	SSH67J-62KY	SSH8-62Y	SSH67J-63KY	SSH8-63Y



# Hydraulic Quick Couplings

# General Purpose Couplings 60 Series Steam Couplings



### Specifications

Body Size (in.)	1/4 to 1
Standard Seal Material	Ethylene Propylene
Temperature Range	up to +400°

### Coupler

#### Female Pipe Thread

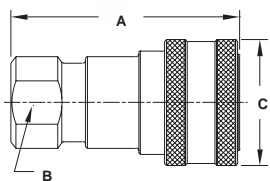

Body Size (in.)	Part No. Brass	Thread Size NPTF	Dimension (in.)			Wt. (LB.) P/Piece
			Overall Length	Wrench Flats	Largest Diameter	
			A	B	C	
1/4	BH2-60-STM	1/4-18	2.26	0.81	1.14	0.30
3/8*	H3-68	3/8-18	2.50	0.88	1.77	0.50
1/2	BH4-60-STM	1/2-14	2.87	1.12	1.77	0.75
3/4	BH6-60-STM	3/4-14	3.56	1.31	2.14	1.31
1	BH8-60-STM	1-11 1/2	4.18	1.62	2.52	1.95

\* See Photo and Drawing below for 3/8 inch size coupler configuration.

#### Coupler - 3/8 Inch Configuration

#### Female Pipe Thread

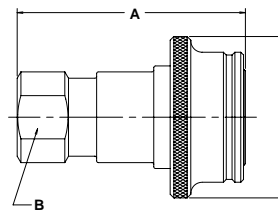

### Nipple

#### Female Pipe Thread

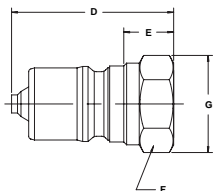

Body Size (in.)	Part No. Brass	Thread Size NPTF	Dimension (in.)				Wt. (LB.) P/Piece
			Overall Length	Exposed* Length	Hex Size	Largest Diameter	
			D	E	F	G	
1/4	BH2-61-STM	1/4-18	1.54	0.65	0.75	0.87	0.08
3/8	H3-69	3/8-18	1.68	0.52	0.88	1.01	0.13
1/2	BH4-61-STM	1/2-14	1.94	0.69	1.12	1.30	0.24
3/4	BH6-61-STM	3/4-14	2.43	0.79	1.38	1.59	0.46
1	BH8-61-STM	1-11 1/2	2.91	0.99	1.62	1.88	0.76

\* This dimension represents the portion that is exposed when the nipple is inserted into the mating Parker Coupler.

### Repair Kits

#### Steam Coupling

Body Size	Repair Kit Part No.	Used For Part No.
3/8	H68E-67K	H3-68
3/8	H69E-67K	H3-69





### Features

- Poppet valves are mated with a solid metal perch that maintains valve alignment and prevents flow checking.
- Both the coupler's sleeve and the nipple's body are hardened to make the 6600 Series couplings resistant to damage from brinelling and mechanical shock.
- The durable-ball-locking mechanism ensures a reliable connection every time.
- 6600 Series couplings have female pipe and straight thread end configurations as standard.
- Parker 6600 Series couplings interchange with couplings meeting ISO 7241-1, Series A.

### Applications

Versatile Parker 6600 Series couplings are used in a wide range of hydraulic applications including construction equipment, manufacturing machinery, and in-plant systems. They can be found anywhere the fluid transfer lines need to be connected and disconnected for operation or maintenance of equipment. Rugged construction makes the 6600 Series a good choice for mobile applications including dump trucks, snow plows, refuse hauling, mining, asphalt paving, truck trailer connections and many more. In-plant machinery applications include hydraulic fluid, chemicals and gas lines for paper mills, steel production, and many varieties of plant maintenance and production equipment.

**Note:** Protective dust plugs and caps play a crucial role in the life of a quick coupling and no purchase of a hydraulic quick coupling is complete without the selection of an appropriate dust plug and cap. See pages noted in Table of Contents for dust plugs and caps for the Parker full line of hydraulic couplings.

### Specifications

Body Size (in.)	1/4	3/8	1/2	3/4	1
Rated Pressure (PSI)	5000	4000	4000	4000	4000
Rated Flow (GPM)	0.8	6	12	28	50
Temperature Range (Nitrile seals)	-40° to +250° F				

### Performance

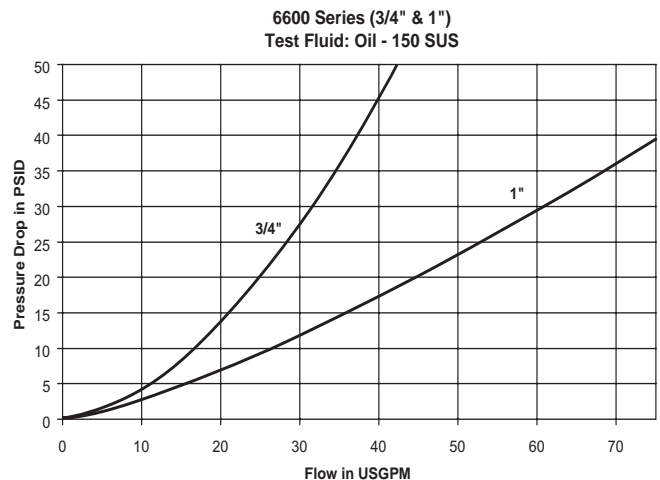
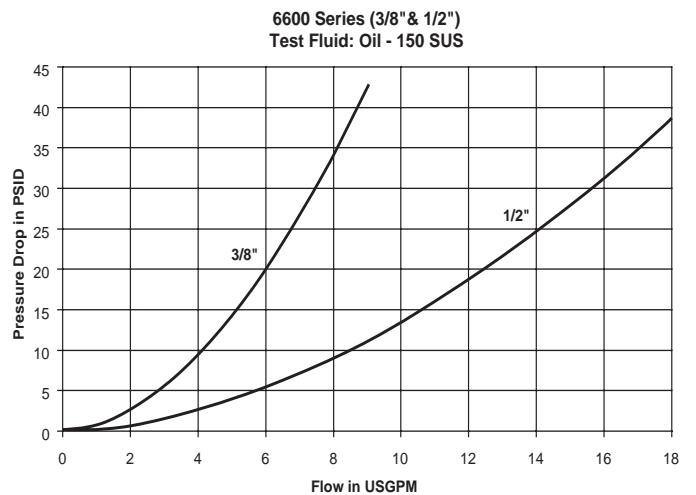
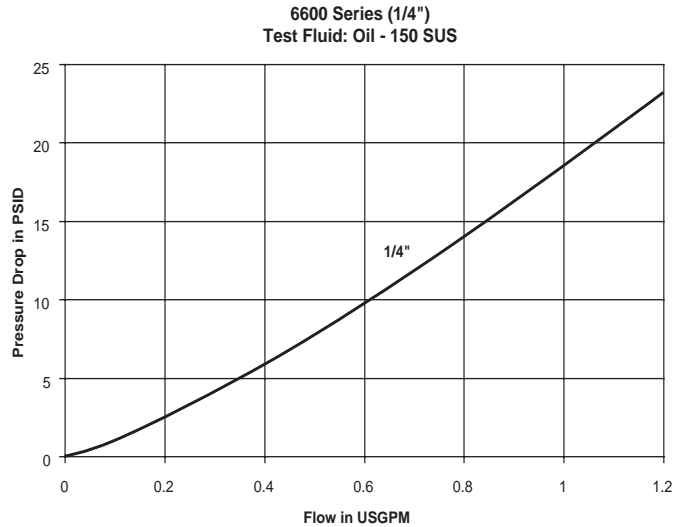

## Hydraulic Quick Couplings

## General Purpose Couplings 6600 Series

### Couplers

#### Female Thread

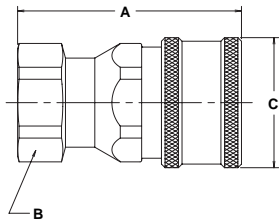

Body Size (in.)	Part No. Steel	Thread Size NPTF	Thread Size ORB	Dimensions (in.)			Wt. (LB.) P/Piece
				Overall Length	Hex Size	Largest Diameter	
				A	B	C	
1/4	6601-2-4	1/8-27	—	1.85	.88	1.08	0.27
1/4	6601-4-4	1/4-18	—	1.85	.88	1.08	0.26
3/8	6601-6-6	3/8-18	—	2.18	1.06	1.27	0.39
3/8	6608-6-6	—	9/16-18	2.18	1.06	1.27	0.38
1/2	6601-8-10	1/2-14	—	2.75	1.25	1.52	0.67
1/2	6601-12-10	3/4-14	—	2.88	1.38	1.52	0.71
1/2	6608-8-10	—	3/4-16	2.74	1.25	1.52	0.67
1/2	6608-10-10	—	7/8-14	2.79	1.25	1.52	0.64
1/2	6608-12-10	—	1 1/16-12	3.01	1.38	1.52	0.77
3/4	6601-12-12	3/4-14	—	3.36	1.62	1.90	1.31
3/4	6608-12-12	—	1 1/16-12	3.35	1.62	1.90	1.31
1	6601-16-16	1-11 1/2	—	4.11	1.88	2.14	1.93
1	6608-16-16	—	1 5/16-12	4.11	1.88	2.14	1.75

### Nipples

#### Female Thread

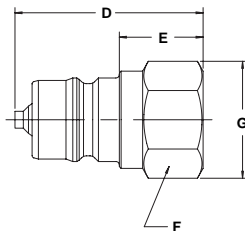

Body Size (in.)	Part No. Steel	Thread Size NPTF	Thread Size ORB	Overall Length	Dimensions (in.)			Wt. (LB.) P/Piece
					Exposed* Length	Hex Size	Largest Diameter	
				D	E	F	G	
1/4	6602-2-4	1/8-27	—	1.41	.50	.56	.65	0.05
1/4	6602-4-4	1/4-18	—	1.41	.58	.75	.87	0.07
3/8	6602-6-6	3/8-18	—	1.63	.72	.88	1.01	0.11
3/8	6610-6-6	—	9/16-18	1.63	.72	.88	1.01	0.13
1/2	6602-8-10	1/2-14	—	2.08	.78	1.06	1.23	0.21
1/2	6602-12-10	3/4-14	—	2.30	.78	1.38	1.59	0.33
1/2	6610-8-10	—	3/4-16	2.08	.76	1.06	1.23	0.22
1/2	6610-10-10	—	7/8-14	2.08	.82	1.12	1.30	0.21
1/2	6610-12-10	—	1 1/16-12	2.30	1.04	1.38	1.59	0.33
3/4	6602-12-12	3/4-14	—	2.55	1.18	1.38	1.59	0.49
3/4	6610-12-12	—	1 1/16-12	2.55	1.18	1.38	1.59	0.47
1	6602-16-16	1-11 1/2	—	3.10	1.34	1.62	1.88	0.75
1	6610-16-16	—	1 5/16-12	3.10	1.34	1.62	2.17	0.72

\* This dimension represents the portion that is exposed when the nipple is inserted into the mating parker Coupler.

### Replacement Parts

#### 6600 Series

Body Size (in.)	1/4	3/8	1/2	3/4	1
O-Rings - Nitrile	50001-112-0010	50001-115-0010	50001-211-0010	50001-123-0010	50001-126-0010
Back-up Rings	4118006	4118005	50-140-4	4138001	4148002



### Features

The SM Series couplings feature:

- Poppet valves with captive valve seals: the valve seal is positively captured by the metal poppet to minimize seal washout.
- Coupler and nipple are precision machined from solid barstock.
- SM Series are available in female pipe (NPTF), SAE O-Ring Boss and British Pipe (BSPP) as standard.

### Applications

SM Series couplings are used across the spectrum of hydraulic applications. These Double Shut-Off couplings can be found anywhere that fluid transfer lines need to be connected and disconnected for operation or maintenance of equipment, and a loss of fluid is undesirable. Designed for use with commercial grades of hydraulic fluids. These couplings are ideally suited for all mobile or industrial applications.

### Specifications

Body Size (in.)	1/4	1/2	3/4
Rated Pressure (PSI)	6,000	6,000	4,500
Rated Flow (GPM)	3	12	28
Temperature Range (Nitrile Seals)	-40° to +250°F		

**Note:** Protective dust plugs and caps play a crucial role in the life of a quick coupling and no purchase of a hydraulic quick coupling is complete without the selection of an appropriate dust plug and cap. See pages noted in Table of Contents for dust plugs and caps for the Parker full line of hydraulic couplings.

### Performance

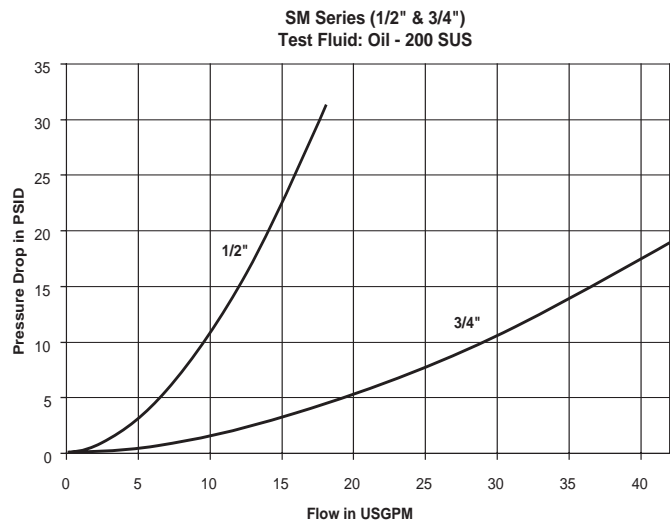
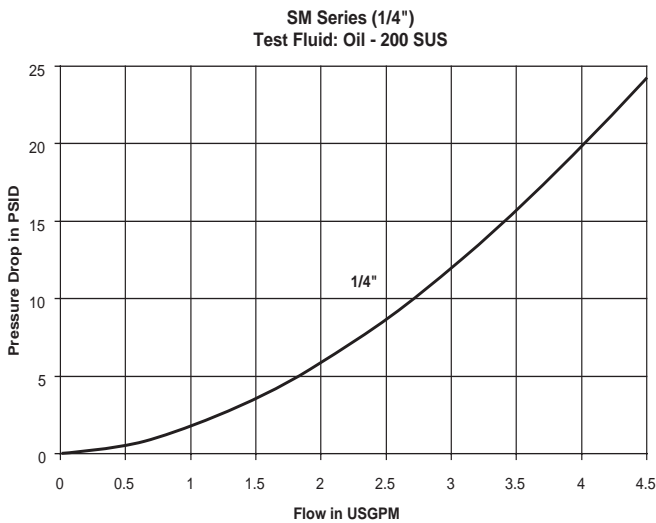

### Couplers

#### Female Thread

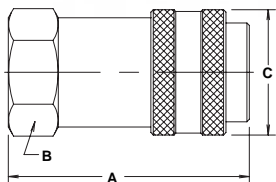

Body Size (in.)	Part No. Steel	Thread Size	Dimensions (in.)			Wt. (LB.) P/Piece
			Overall Length	Hex Size	Largest Diameter	
			A	B	C	
1/4	SM-251-4FP	1/4-18 NPTF	2.09	0.75	1.06	0.24
1/4	SM-251-4FB	G1/4 BSPP	2.24	0.75	1.06	0.26
1/4	SM-251-6FP	3/8-18 NPTF	2.24	0.94	1.06	0.28
1/4	SM-251-6FB	G3/8 BSPP	2.24	0.94	1.06	0.26
1/4	SM-251-6FO	9/16-18ORB	2.24	0.75	1.06	0.25
1/2	SM-501-8FP	1/2-14 NPTF	3.00	1.25	1.56	0.70
1/2	SM-501-8FB	G1/2 BSPP	3.00	1.25	1.56	0.74
1/2	SM-501-12FP	3/4-14 NPTF	3.07	1.37	1.56	0.81
1/2	SM-501-12FB	G3/4 BSPP	3.16	1.37	1.56	0.85
1/2	SM-501-8FO	3/4-16ORB	3.16	1.25	1.56	0.70
3/4	SM-751-12FO	1 1/16-12ORB	3.89	1.62	2.25	1.78
3/4	SM-751-12FP	3/4-14 NPTF	3.77	1.62	2.22	1.83
3/4	SM-751-12FB	G3/4 BSPP	3.89	1.62	2.22	1.88
3/4	SM-751-16FP	1-11 1/2 NPTF	3.98	1.62	2.22	1.84
3/4	SM-751-16FB	G 1 BSPP	3.98	1.62	2.22	1.89
3/4	SM-751-16FO	1-5/16-12ORB	3.98	1.62	2.22	1.89

### Nipples

#### Female Thread

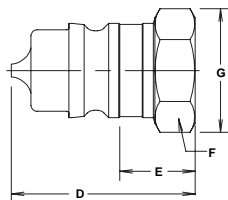

Body Size (in.)	Part No. Steel	Thread Size	Dimensions (in.)				Wt. (LB.) P/Piece
			Overall Length	Exposed* Length	Hex Size	Largest Diameter	
			D	E	F	G	
1/4	SM-252-4FP	1/4-18 NPTF	1.49	0.50	0.75	0.87	0.08
1/4	SM-252-4FB	G1/4 BSPP	1.64	0.65	0.75	0.87	0.09
1/4	SM-252-6FP	3/8-18 NPTF	1.64	0.81	0.94	1.08	0.14
1/4	SM-252-6FB	G3/8 BSPP	1.64	0.81	0.94	1.08	0.14
1/4	SM-252-6FO	9/16-18ORB	1.64	0.55	0.75	0.87	0.08
1/2	SM-502-8FO	3/4-16ORB	2.14	0.72	1.06	1.23	0.16
1/2	SM-502-8FP	1/2-14 NPTF	2.01	0.45	1.06	1.23	0.15
1/2	SM-502-8FB	G1/2 BSPP	2.01	0.60	1.06	1.23	0.18
1/2	SM-502-12FP	3/4-14 NPTF	2.31	0.90	1.37	1.59	0.30
1/2	SM-502-12FB	G3/4 BSPP	2.63	1.07	1.37	1.59	0.34
3/4	SM-752-12FO	1 1/16-12ORB	2.60	0.39	1.50	1.73	0.48
3/4	SM-752-12FP	3/4-14 NPTF	2.48	0.39	1.50	1.73	0.52
3/4	SM-752-12FB	G3/4 BSPP	2.60	0.53	1.50	1.73	0.56
3/4	SM-752-16FP	1-11 1/2 NPTF	2.69	0.67	1.62	1.88	0.56
3/4	SM-752-16FB	G 1 BSPP	2.69	0.67	1.62	1.88	0.68
3/4	SM-752-16FO	1-5/16-12ORB	2.69	0.67	1.62	1.88	0.68

\* This dimension represents the portion that is exposed when the nipple is inserted into the mating parker Coupler.

### Optional Seals



Optional Seals Suffix (Standard seals are Nitrile)	
E4	Fluorocarbon
E5	Ethylene Propylene (EPR)
E12	Neoprene
	Perfluoroelastomer (Contact Factory for Seal Options)



### Features

- Operating pressures up to 5,000 PSI (350 Bar).
- Soft seat valving prevents leakage when coupler and nipple are disconnected.
- Made of Carbon Steel. Exterior is Chromium-6 Free plated for corrosion resistance.
- Smooth Flow Path Minimizes Pressure Drop.
- Nitrile Body Seal supported by PTFE washer. Backup washer keeps seal from extruding at high pressures.
- Heat Treated Nipple and Heavy Duty Locking Collar withstands high pressure surges, hose twist and repeated pressure pulses.
- Nitrile Seals for General Purpose Hydraulic Applications.

### Specifications

Body Size (in.)	1	1-1/2
Rated Pressure (PSI)	5,000	5,000
Rated Flow (GPM)	50	100
Temperature Range (std seals)	-40° to +250°F	

### Performance

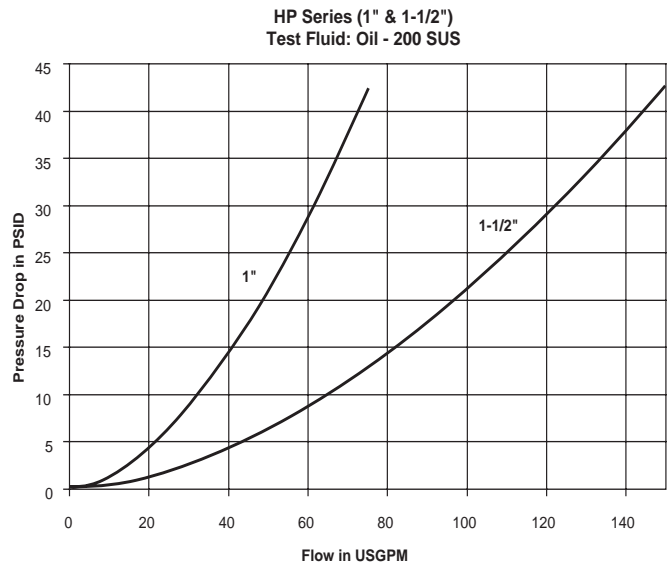

## Hydraulic Quick Couplings

## General Purpose Couplings HP Series (High Pressure Coupling)

### Couplers

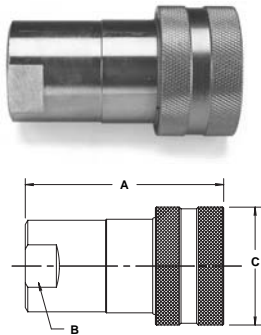

Body Size (in.)	Part No.	Thread Size	Overall Length	Wrench Flats	Largest Diameter	Wt. (LB.) P/Piec
			A	B	C	
1	HP-1001-16FP	1 11-1/2 NPSF	3.95	1.62	2.38	2.10
1	HP-1001-16FO	1 15/16-12ORB	4.35	1.62	2.38	2.10
1 1/2	HP-1501-24FP	1 1/2-11 1/2 NPTF	4.93	2.25	3.00	4.40
1 1/2	HP-1501-24FO	1 7/8 -12 ORB	4.93	2.25	3.00	4.40

### Nipples

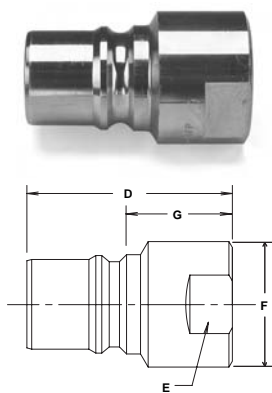

Body Size (in.)	Part No.	Thread Size	Overall Length	Wrench Flats	Largest Diameter	Exposed Length*	Wt. (LB.) P/Piece
			D	E	F	G	
1	HP-1002-16FP	1 11-1/2 NPSF	3.00	1.62	1.88	1.32	0.84
1	HP-1002-16FO	1 15/16-12ORB	3.40	1.62	1.88	1.72	0.84
1 1/2	HP-1502-24FP	1 1/2-11 1/2 NPTF	4.06	2.25	2.63	.99	1.85
1 1/2	HP-1502-24FO	1 7/8-12 ORB	4.06	2.25	2.63	.99	1.85

\* This dimension represents the portion that is exposed when the nipple is inserted into the mating Parker Coupler.

### Dust Plugs and Caps

Protective Plugs for Coupler			Protective Caps for Nipple		
P/N	Material	Fits Coupler	P/N	Material	Fits Nipple
HPP-100	Aluminum	HP-1001	HPC-100	Aluminum	HP-1002
HPP-150	Aluminum	HP-1501	HPC-150	Aluminum	HP-1502



### Applications

The 4000 Series brings to the industry a proven design for use on construction equipment, forestry equipment, agricultural machinery, oil tools, steel mill machinery, and other demanding hydraulic applications.

**Note:** Protective dust plugs and caps play a crucial role in the life of a quick coupling and no purchase of a hydraulic quick coupling is complete without the selection of an appropriate dust plug and cap. See pages noted in Table of Contents for dust plugs and caps for the Parker full line of hydraulic couplings.

### Special Order Information

Standard seal material is Nitrile, other seal options are available. See Ordering Information at end of Section B and Fluid Compatibility Chart at end of this catalog for assistance in making seal selection.

Note: The part numbers for the 4000 Series Poppet Valve design are designated with a -P. For example 4050-4P.

### Specifications

Body Size (in.)	1/4	3/8	1/2	3/4	1
Rated Pressure (PSI)	3000	3000	3000	3000	3000
Rated Flow (GPM)	3	6	12	28	50
Temperature Range (std seals)	-40° to +250°F				

### Features

Parker 4000 Series couplings feature:

- Poppet valves available to prevent uncoupled leakage.
- Ball valves available for rugged dependability in heavy-duty hydraulic applications, within rated working pressures.
- Critical parts are induction hardened for durability.
- Dependable ball-locking mechanism holds the mating halves together.
- Couplers and nipple are precision machined from solid bar stock.
- For applications with residual trapped pressure use connect-under-pressure nipples designated by the -DC option.
- The mating 8010 series nipples meet ISO 5675 requirements.

### Performance

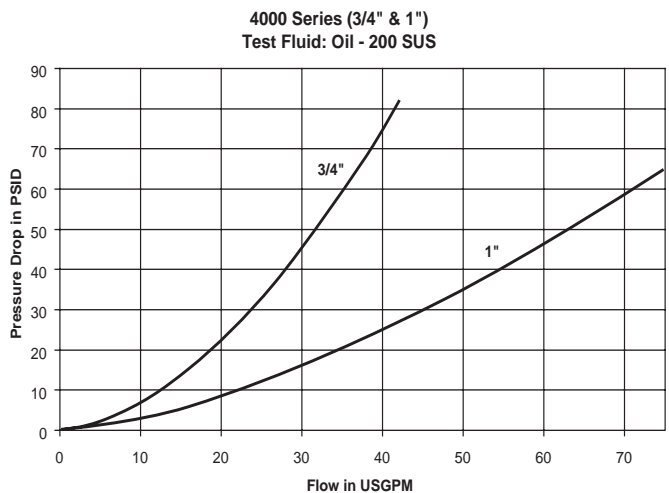
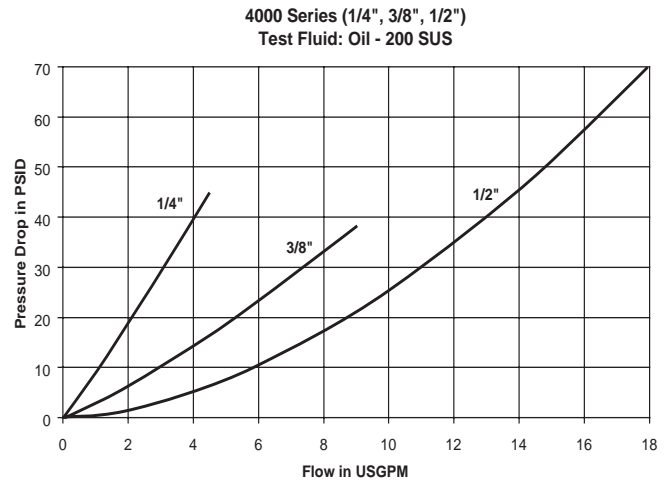

# Hydraulic Quick Couplings

# General Purpose Couplings 4000 Series

## Couplers

### Female Thread

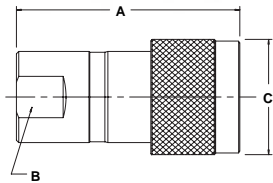
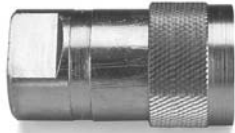

Body Size (in.)	Part No. Steel*	Thread Size NPTF	Thread Size ORB	Thread Size BSPP	Dimensions (in.)			Wt. (LB.) P/Piece	
					Overall Length	Wrench Flats	Largest Diameter		
					A	B	C		
1/4	4050-2P	1/4-18	-		2.18	0.88	1.06	0.24	
1/4	4050-2P-T8M	-	3/4-16 (Male)		1.80	0.88	1.06	0.21	
1/4	4050-T6	-	9/16-18		2.18	0.88	1.06	0.27	
1/4	4050P-T6**	-	9/16-18		2.43	0.81	1.33	0.33	
3/8	4050-3P	3/8-18	-		2.31	0.94	1.33	0.51	
1/2	4050-4	1/2-14	-		2.60	1.06	1.52	0.58	
1/2	4050-4P	1/2-14	-		2.60	1.06	1.52	0.58	
1/2	4050-5	3/4-14	-		2.69	1.13	1.52	0.71	
1/2	4050-5P	3/4-14	-		2.69	1.13	1.52	0.71	
1/2	4050-15	-	3/4-16		2.81	1.06	1.52	0.64	
1/2	4050-15P	-	3/4-16		2.81	1.06	1.52	0.64	
1/2	4050-16	-	7/8-14		2.75	1.06	1.52	0.59	
1/2	4050-16P	-	7/8-14		2.75	1.06	1.52	0.59	
1/2	4050-29BSPP	-	-	1/2-14	2.68	1.06	1.52	0.59	
3/4	4150-5	3/4-14	-		3.50	1.38	1.90	1.00	
1	4050-6P	1-11 1/2	-		3.84	1.63	2.08	1.89	

\* P in part number designates Poppet design

\*\* Push-to-Connect design.

## Nipples

### Female Thread

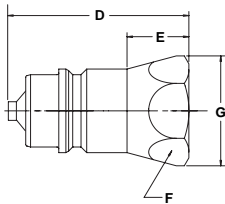

Body Size (in.)	Part No. Steel*	Thread Size NPTF	Thread Size ORB	Thread Size BSPP	Dimensions (in.)				Wt. (LB.) P/Piece	
					Overall Length	Exposed Length†	Hex Size	Largest Diameter		
					D	E	F	G		
1/4	4010-2P	1/4-18	-		1.39	0.71	0.75	0.87	0.08	
1/4	4010-T6	-	9/16-18		1.49	0.81	0.75	0.87	0.09	
3/8	4010-3P	3/8-18	-		1.50	.80	.94	1.08	0.16	
1/2	8010-4	1/2-14	-		1.95	1.09	1.06	1.23	0.20	
1/2	8010-4P	1/2-14	-		1.95	1.09	1.06	1.23	0.20	
1/2	8010-5	3/4-14	-		2.14	1.28	1.25	1.44	0.25	
1/2	8010-5P	3/4-14	-		2.14	1.28	1.25	1.44	0.25	
1/2	8010-15	-	3/4-16		2.06	1.20	1.06	1.23	0.20	
1/2	8010-15P	-	3/4-16		2.06	1.20	1.06	1.23	0.20	
1/2	8010-16	-	7/8-14		2.05	1.18	1.06	1.23	0.25	
1/2	8010-16P	-	7/8-14		2.05	1.18	1.06	1.23	0.25	
1/2	8010-29BSPP	-	-	1/2-14	1.95	1.09	1.06	1.18	0.25	
3/4	4110-5	3/4-14	-		1.81	1.23	1.31	1.52	0.50	
1	4010-6P	1-11 1/2	-		2.79	1.49	1.63	1.88	0.62	

\* P in part number designates Poppet design

† This dimension represents the portion that is exposed when the nipple is inserted into the mating Parker Coupler.

## Connect-Under-Pressure

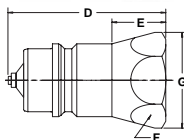

Body Size (in.)	Part No. Steel*	Thread Size NPTF	Thread Size ORB	Thread Size BSPP	Dimensions (in.)				Wt. (LB.) P/Piece	
					Overall Length	Exposed Length†	Hex Size	Largest Diameter		
					D	E	F	G		
1/2	8010-4P-DC	1/2-14	-	-	1.81	1.09	1.06	1.16	0.20	
1/2	8010-15P-DC	-	3/4-16	-	1.81	1.09	1.06	1.16	0.20	

## Replacement Parts - 4000 Series

Body Size (in.)	1/4	3/8	1/2	3/4	1
O-Rings - Nitrile	50001-113-0260	50001-116-0260	50001-211-0260	50001-215-0010	50001-218-0260





### Applications

The 4200 Series brings to the industry a proven design for use on construction equipment, forestry equipment agricultural machinery, and oil tools.

**Note:** Protective dust plugs and caps play a crucial role in the life of a quick coupling and no purchase of a hydraulic quick coupling is complete without the selection of an appropriate dust plug and cap. See pages noted in Table of Contents for dust plugs and caps for the Parker full line of hydraulic couplings.

### Special Order Information

Standard seal material is Nitrile. For other seal options see Table of Contents. See Ordering Information at end of Section B and Fluid Compatibility Chart at end of this catalog for assistance in making seal selection.

Note: The part numbers for the 4200 Series Poppet Valve design are designated with a -P. For example 4250-4P.

### Features

Parker 4200 Series couplings feature:

- Double acting sleeve for one handed push-to-connect operation when coupler is clamp or bulkhead mounted.
- Poppet valves available to prevent uncoupled leakage.
- Ball valves available for rugged dependability in heavy-duty hydraulic applications, within rated working pressures.
- Critical parts are induction hardened for durability.
- Dependable ball-locking mechanism holds the mating halves together.
- Couplers and nipple are precision machined from solid bar stock.
- For applications with residual trapped pressure use connect-under-pressure nipples designated by the -DC option.

### Specifications

Body Size (in.)	3/8	1/2
Rated Pressure (PSI)	3000	3000
Rated Flow (GPM)	6	12
Temperature Range (std seals)	-40° to +250°F	

### Performance

4200 Series (3/8" & 1/2")  
Test Fluid: Oil - 200 SUS

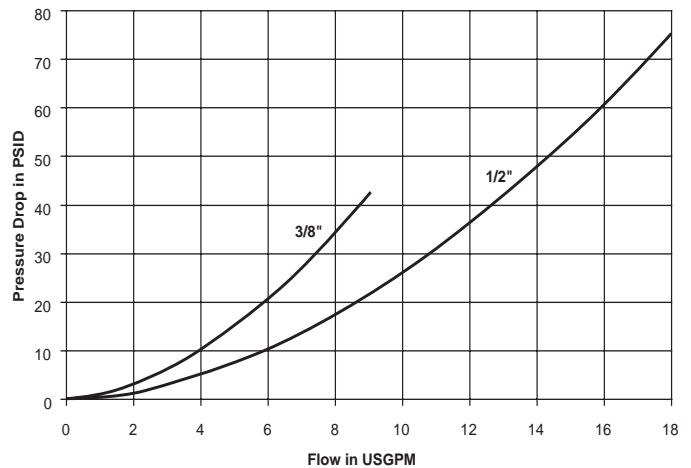

## Hydraulic Quick Couplings

## General Purpose Couplings 4200 Series

### Couplers

#### Female Thread

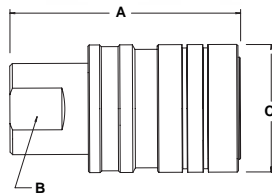

Body Size (in.)	Part No. Steel*	Thread Size NPTF	Thread Size ORB	Dimensions (in.)			Wt. (LB.) P/Piece
				Overall Length	Wrench Flats	Largest Diameter	
				A	B	C	
3/8	4250-3P	3/8-18	–	2.31	0.81	1.31	0.39
1/2	4250-4	1/2-14	–	2.68	0.94	1.50	0.55
1/2	4250-4P	1/2-14	–	2.68	0.94	1.50	0.55
1/2	4250-15	–	3/4-16	2.68	0.94	1.50	0.55
1/2	4250-15P	–	3/4-16	2.68	0.94	1.50	0.55

\* P in part number designates Poppet design

### Nipples

#### Female Thread

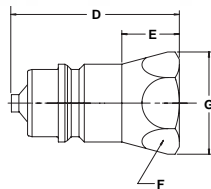

Body Size (in.)	Part No. Steel*	Thread Size NPTF	Thread Size ORB	Overall Length	Dimensions (in.)			Wt. (LB.) P/Piece
					Exposed Length**	Hex Size	Largest Diameter	
					D	E	F	G
3/8	4010-3P	3/8-18	–	1.60	0.80	0.94	1.08	0.16
1/2	8010-4	1/2-14	–	1.95	1.09	1.06	1.23	0.20
1/2	8010-4P	1/2-14	–	1.95	1.09	1.06	1.23	0.20
1/2	8010-15	–	3/4-16	2.06	1.20	1.06	1.23	0.20
1/2	8010-15P	–	3/4-16	2.06	1.20	1.06	1.23	0.20

\* P in part number designates Poppet design

\*\* This dimension represents the portion that is exposed when the nipple is inserted into the mating Parker Coupler.

### Connect-Under-Pressure

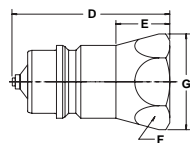

Body Size (in.)	Part No. Steel*	Thread Size NPTF	Thread Size ORB	Thread Size BSPP	Dimensions (in.)				Wt. (LB.) P/Piece
					Overall Length	Exposed Length**	Hex Size	Largest Diameter	
					D	E	F	G	
1/2	8010-4P-DC	1/2-14	–	–	1.81	1.09	1.06	1.16	0.20
1/2	8010-15P-DC	–	3/4-16	–	1.81	1.09	1.06	1.16	0.20

\*\* This dimension represents the portion that is exposed when the nipple is inserted into the mating Parker Coupler.

### Replacement Parts - 4200 Series

Body Size (in.)	Part Number	Description	Material
1/2	50001-211-0260	O-Rings	Nitrile
3/8	50001-116-0260	O-Rings	Nitrile



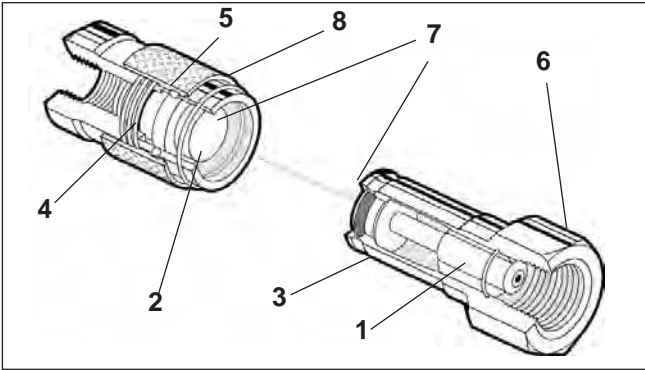

### Applications

Non-Spill couplings by Parker are widely used in the public utility market where hydraulic oil spillage can constitute a serious safety hazard, particularly in overhead bucket hoists that are used for maintenance of high-voltage power transmission lines. These couplings are also used for quick change of hydraulic hand tools in the construction, railway maintenance and mining industries. They are also ideal for in-plant use where excess oil spillage can create a hazard.

**Note:** See pages noted in Table of Contents for dust plugs and caps for the Parker full line of hydraulic couplings.

### Performance

NS Series (3/8" & 1/2")  
Test Fluid: Oil - 200 SUS

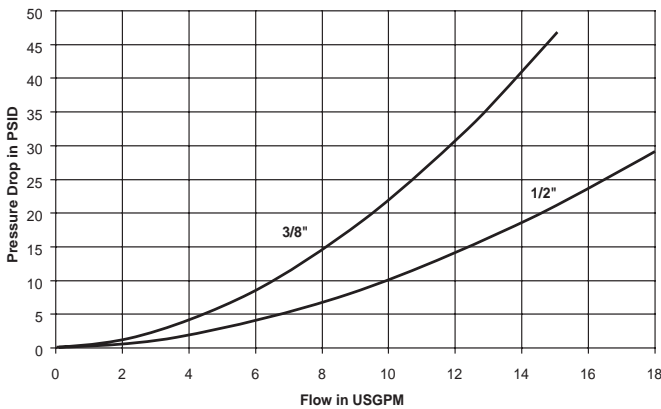

NS Series (3/4" & 1")  
Test Fluid: Oil - 200 SUS

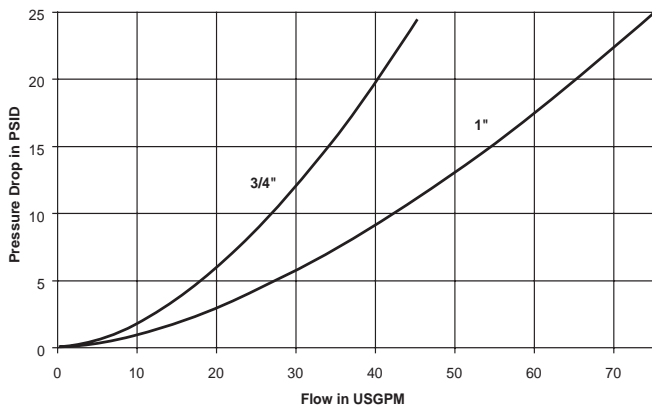

### Features

1. Positive valve stop. The perch maintains valve alignment and provides metal to metal valve stop to ensure that the valves open fully, every time.
2. Captive valve seal assures "bubble tight" poppet sealing. The valve seal is positively captured by the metal poppet to minimize seal washout or damage from high velocity fluid.
3. Steel construction, Chromium-6 Free plated . Hardened nipples and sleeves and solid barstock construction for maximum resistance to damage from hydraulic and mechanical shock.
4. The seal is designed to withstand high pressures and provide reliable sealing. 1/2" and above sizes feature PTFE back-up rings that support mating seals for high pressure applications.
5. Durable ball-locking assure reliable connection, every time. A large number of locking balls distribute the work load evenly while providing alignment and swiveling action to reduce hose torque and prolong hose life.  
  
CAUTION: these products are not to be used as swivels, rotation under pressure will result in excessive and premature wear.
6. Female pipe (NPSF), SAE O-Ring Boss and British pipe (BSPF) are available as standard.
7. Dry-Disconnect Series couplings employ flush valving when connecting or disconnecting. This means that the valves are mated together so that only small amounts of fluid can be lost during disconnection or air included during reconnection.
8. Sleeve locking mechanism prevents accidental disconnection when the coupling is dragged along the ground. Sleeve is rotated to engage the lock. The sleeve-lock feature is standard on this product.

### Specifications

Body Size (in.)	3/8	1/2	3/4	1
Rated Pressure (PSI)	2500	2500	2500	2500
Rated Flow (GPM)	10	12	30	50
Temperature Range (std seals)	-40° to +250°F			
Spillage (ML) (max. per disconnect)	0.020	0.070	0.150	0.220
Air Incl. (ML) (max. per disconnect)	0.010	0.020	0.050	0.070



## Hydraulic Quick Couplings

## Non-Spill Couplings NS Series

### Couplers

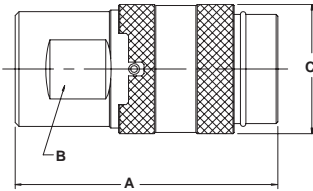

Body Size (in.)	Part No. Steel	Thread Size	Dimensions (in.)			Wt. (LB.) P/Piece
			Overall Length	Hex Size	Largest Diameter	
			A	B	C	
3/8	NS-371-6FP	3/8-18 NPSF	2.10	1.06	1.13	0.36
3/8	NS-371-6FB	G3/8 BSPP	2.10	1.06	1.13	0.38
3/8	NS-371-8FO	3/4-16UNF	2.20	1.06	1.13	0.40
1/2	NS-501-8FP	1/2-14 NPSF	2.88	1.25	1.56	0.80
1/2	NS-501-8FB	G1/2 BSPP	2.95	1.25	1.56	0.74
1/2	NS-501-10FO*	7/8-14UNF	2.97	1.25	1.56	0.80
3/4	NS-751-12FP	3/4-14 NPSF	3.19	1.56	1.96	1.48
3/4	NS-751-12FB	G3/4 BSPP	3.38	1.56	1.96	1.54
3/4	NS-751-12FO	1 1/16-12UN	3.51	1.56	1.96	1.58
1	NS-1001-16FP	1-11 1/2 NPSF	3.70	1.75	2.25	2.35
1	NS-1001-16FB	G 1 BSPP	3.81	1.75	2.25	2.36
1	NS-1001-16FO	1 5/16-12UN	3.81	1.75	2.25	2.36

\* Contact factory for Connect-Under-Pressure option availability in the 1/2" size.

### Nipples

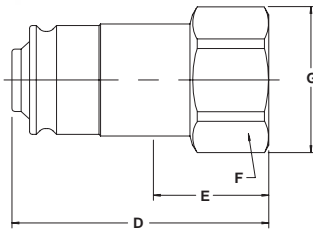

Body Size (in.)	Part No. Steel	Thread Size	Dimensions (in.)				Wt. (LB.) P/Piece
			Overall Length	Exposed* Length	Hex Size	Largest Diameter	
			D	E	F	G	
3/8	NS-372-6FP	3/8-18 NPSF	1.70	1.17	0.94	1.08	0.16
3/8	NS-372-6FB	G3/8 BSPP	1.78	1.25	0.94	1.08	0.16
3/8	NS-372-8FO	3/4-16UNF	1.91	1.38	1.06	1.23	0.20
1/2	NS-502-8FP	1/2-14 NPSF	1.81	0.69	1.06	1.23	0.20
1/2	NS-502-8FB	G1/2 BSPP	1.95	0.83	1.06	1.23	0.22
1/2	NS-502-10FO	7/8-14UNF	2.14	1.02	1.12	1.30	0.28
3/4	NS-752-12FP	3/4-14 NPSF	2.25	1.12	1.37	1.59	0.48
3/4	NS-752-12FB	G3/4 BSPP	2.47	1.34	1.37	1.59	0.54
3/4	NS-752-12FO	1 1/16-12UN	2.62	1.49	1.37	1.59	0.65
1	NS-1002-16FP	1-11 1/2 NSPF	2.64	1.54	1.62	1.88	0.72
1	NS-1002-16FB	G 1 BSPP	2.78	1.68	1.62	1.88	0.74
1	NS-1002-16FO	1 5/16-12UN	2.87	1.77	1.62	1.88	0.80

\* This dimension represents the portion that is exposed when the nipple is inserted into the mating Parker Coupler.

### Standard Port Configurations

- FP - Female Pipe Thread
- FO - Female Straight Thread
- FB - Female British Standard Pipe Parallel

### Optional Seals



Optional Seals Suffix	
E4	Fluorocarbon
E5	Ethylene Propylene (EPR)
E35	Perfluoroelastomer (Contact factory for Seal options)

# Hydraulic Quick Couplings

## Non-Spill Adapters

### Applications

Parker Non-Spill Adapters were designed due to the widespread use of several coupling types in the construction market. These adapters help the user adapt between poppet style couplings and non-spill type couplings. Adapters are widely available with Parker FEM and FF Series to Parker 6600 Series coupling connections. This product is especially useful where multiple hydraulic attachments are being used with skid steer loaders.

### Materials Of Construction

Body: Steel  
 Finish: Chromium-6 Free plating

### Specifications

Body Size (in.)	1/2
Rated Pressure (PSI) – EAS/SAE	3625
Temperature Range	-40° to + 250°F
Max Spillage Per Disconnect (ml.) (Flush Face End)	.020
Max Air Inclusion Upon Connect (ml.) (Flush Face End)	.070
Rated Flow (GPM)	12

### Adapters

#### EAS-500

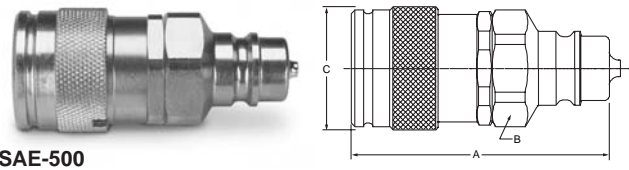

#### SAE-500

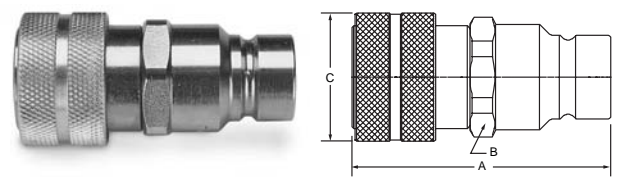

### How To Order

#### Adapter Part Number

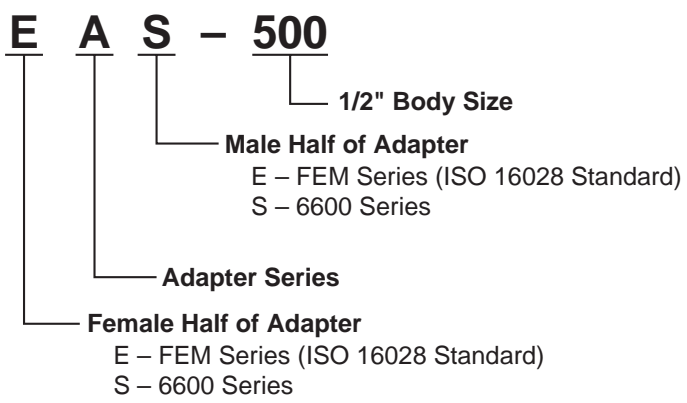

Body Size	Part Number	Thread Size	Overall Length		
			A	B	C
1/2	EAS-500	NA	3.364	1.380	1.50
1/2	SAE-500	NA	3.000	1.250	1.48

### Performance

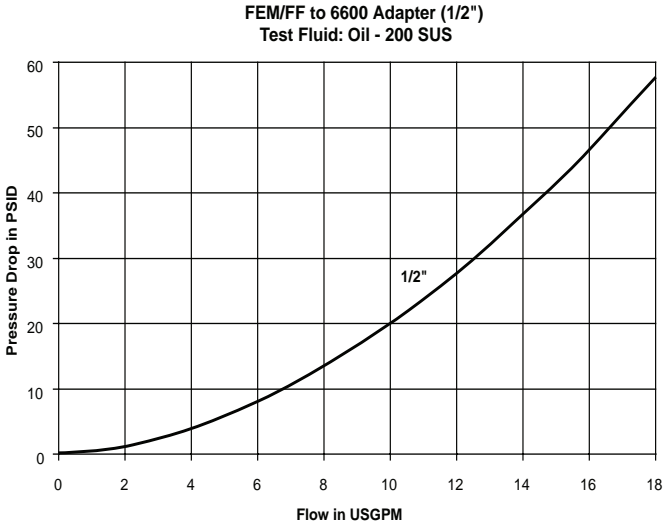

# Hydraulic Quick Couplings

## Non-Spill Couplings FF Series

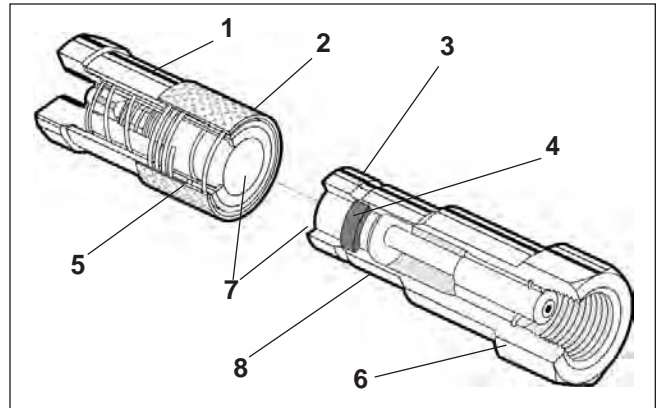

### Applications

Parker FF Series couplings are widely used in the public utility market where hydraulic oil spillage can constitute a serious safety hazard, particularly in overhead bucket hoists that are used for maintenance of high-voltage power transmission lines. These couplings are also used for quick change of hydraulic tools in construction, railway maintenance and mining industries. The ease of cleaning makes them ideal for use in these types of hostile environments.

**Note:** See pages noted in Table of Contents for dust plugs and caps for the Parker full line of hydraulic couplings.

### Performance

FF Series (1/4", 3/8", 1/2")  
Test Fluid: Oil - 200 SUS

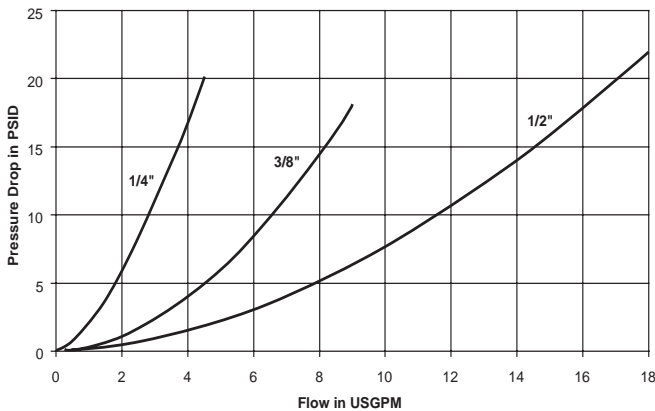

FF Series (3/4" & 1")  
Test Fluid: Oil - 200 SUS

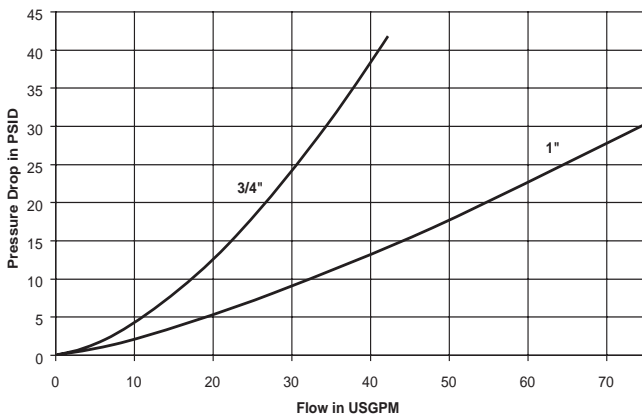

### Features

1. Sleeve locking mechanism is engaged by rotating sleeve after connection. It prevents accidental disconnection when, for example, the coupling is dragged along the ground during use.
2. Sleeve mechanism is designed to help prevent dirt from entering the internal mechanism and thus causing faulty operation when connecting or disconnecting. The sleeve covers the retaining ring and also incorporates a dust seal in the spring area.
3. Steel construction, with Chromium-6 Free plating. Hardened nipples and sleeves and solid barstock construction for maximum resistance to damage from hydraulic and mechanical shock.
4. The blow-out resistant seal is designed to prevent damage during severe service conditions.
5. Durable ball-locking mechanism assures reliable connections, every time. A large number of locking balls distributes the work load evenly while providing alignment and swiveling action to reduce hose torque and prolong hose life. CAUTION: These products are not to be used as swivels. Rotation under pressure will result in excessive and premature wear.
6. Female pipe (NPSF), British pipe (BSPP) and SAE O-Ring Boss are available as standard.
7. FF Series couplings employ flush valving when connecting or disconnecting. This means that the valves are mated together so that only small amounts of fluid can be lost during disconnection or air inclusion during reconnection.
8. The 3/8" size conforms to HTMA (Hydraulic Tool Manufacturers Association) standards. All sizes incorporate flush face mating surfaces which greatly facilitate cleaning of the product when disconnected. HTMA couplings (3/8" only)-coupler and nipple are marked with a directional flow arrow as per specifications. However, couplings are bi-directional.

### Specifications

Body Size (in.)	1/4	3/8	1/2	3/4	1
Rated Pressure (PSI)	5000	3000	3000	3000	3000
Rated Flow (GPM)	3	6	12	28	50
Temperature Range	-40° to + 250°F				
Spillage (ML) (max. per disconnect)	.015	.015	.020	.150	.200
Air Inclusion (ML) (max. per connect)	.020	.020	.070	.100	.150



# Hydraulic Quick Couplings

# Non-Spill Couplings FF Series

B Hydraulics

## Couplers

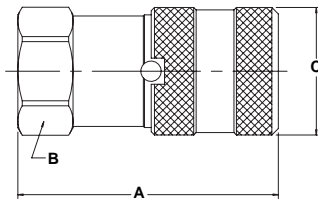

Body Size (in.)	Part No. Steel	Thread Size	Dimensions (in.)			Wt. (LB.) P/Piece
			Overall Length	Hex Size	Largest Diameter	
			A	B	C	
1/4	FF-251-4FP	1/4-18 NPSF	1.79	1.00	1.06	0.23
1/4	FF-251-4MP	1/4-18 NPTF	1.84	1.00	1.06	0.24
1/4	FF-251-6FO	9/16-18 UNF	1.91	1.00	1.06	0.23
3/8	FF-371-6FP	3/8-18 NPSF	2.39	1.06	1.20	0.44
3/8	FF-371-8FP	1/2-14 NPSF	2.80	1.06	1.20	0.50
3/8	FF-371-6FB	G3/8 BSPP	2.45	1.06	1.20	0.45
3/8	FF-371-8FB	G1/2 BSPP	2.80	1.06	1.20	0.48
3/8	FF-371-8FO	3/4-16 UNF	2.82	1.06	1.20	0.52
1/2	FF-501-8FP	1/2-14 NPSF	2.67	1.37	1.58	0.88
1/2	FF-501-10FO	7/8-14 UNF	2.89	1.37	1.58	1.05
3/4	FF-751-12FP	3/4-14 NPSF	3.50	1.75	1.94	1.84
3/4	FF-751-12FO	1 1/16-12 UNF	3.75	1.75	1.94	1.93
1	FF-1001-16FP	1-11 1/2NPSF	4.14	1.87	2.25	2.64
1	FF-1001-16FO	1 5/16-12UNF	4.24	1.87	2.25	2.68

## Nipples

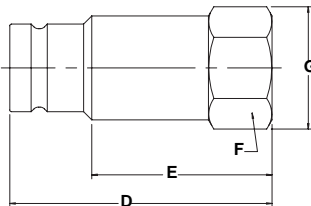

Body Size (in.)	Part No. Steel	Thread Size	Dimensions (in.)				Wt. (LB.) P/Piece
			Overall Length	Exposed* Length	Hex Size	Largest Diameter	
			D	E	F	G	
1/4	FF-252-4FP	1/4-18 NPSF	1.66	1.15	1.00	1.06	0.16
1/4	FF-252-4MP	1/4-18 NPTF	1.72	1.18	1.00	1.06	0.26
1/4	FF-252-6FO	9/16-18 UNF	1.66	1.15	1.00	1.06	0.16
3/8	FF-372-6FP	3/8-18 NPSF	2.31	1.71	0.94	1.08	0.26
3/8	FF-372-8FP	1/2-14 NPSF	2.64	2.04	1.06	1.19	0.32
3/8	FF-372-6FB	G3/8 BSPP	2.45	1.86	0.94	1.08	0.28
3/8	FF-372-8FB	G1/2 BSPP	2.70	2.16	1.06	1.19	0.32
3/8	FF-372-8FO	3/4-16 UNF	2.70	2.16	1.06	1.19	0.30
1/2	FF-502-8FP	1/2-14 NPSF	2.75	2.11	1.12	1.30	0.42
1/2	FF-502-10FO	7/8-14 UNF	2.97	2.29	1.12	1.30	0.44
3/4	FF-752-12FP	3/4-14 NPSF	3.38	2.47	1.50	1.73	1.00
3/4	FF-752-12FO	1 1/16-12 UNF	3.58	2.64	1.50	1.73	1.02
1	FF-1002-16FP	1-11 1/2NPSF	3.85	2.60	1.87	2.17	1.60
1	FF-1002-16FO	1 5/16-12UNF	3.85	2.60	1.87	2.17	1.70

\* This dimension represents the portion that is exposed when the nipple is inserted into the mating Parker Coupler.

### Standard Port Configurations

- FP - Female Pipe Thread
- MP - Male Pipe Thread
- FO - Female Straight Thread
- FB - Female British Standard Pipe Parallel

## Optional Seals



Optional Seals Suffix*	
- E4	Fluorocarbon
- E5	Ethylene Propylene (EPR)
- E35	Perfluoroelastomer (Contact Factory for Seal Options).

\* Optional seals include O-ring & Back-Up Ring, not Anti-Blow Out bonded seal.

## FF Series Repair Kits

1/4" Nipple	3/8" Nipple	1/2" Nipple	3/4" Nipple	1" Nipple	1/4" Coupler	3/8" Coupler	1/2" Coupler	3/4" Coupler	1" Coupler
FF-252-KIT	FF-372-KIT	FF-502-KIT	FF-752-KIT	FF-1002-KIT	FF-251-KIT	N/A	N/A	FF-751-KIT	FF-1001-KIT
FF-252-KIT-E4	FF-372-KIT-E4	FF-502-KIT-E4	FF-752-KIT-E4	FF-1002-KIT-E4	FF-251-KIT-E4	N/A	N/A	FF-751-KIT-E4	FF-1001-KIT-E4
FF-252-KIT-E5	FF-372-KIT-E5	FF-502-KIT-E5	FF-752-KIT-E5	FF-1002-KIT-E5	FF-251-KIT-E5	N/A	N/A	FF-751-KIT-E5	FF-1001-KIT-E5
					FF/FS-251-TOOL	N/A	N/A	FF/FS-751-TOOL	FF/FS-1001-TOOL





FEM Series couplings are designed to meet the stringent design and pressure requirements of ISO 16028. The FEM modular design also facilitates wider variations in fitting options. Parker FEM couplers are designed for use in the construction, utility and agricultural equipment markets. As with all Parker flush-face designs the non-spill feature eliminates hydraulic spillage and air inclusion when connecting or disconnecting hydraulic attachments. The FEM Series is also ideal for many other applications where hydraulic spillage is a concern and global interchangeability with other manufacturers is important.

**Materials of Construction**

- Body:** Steel
- Finish:** Chromium-6 Free plating
- Valve:** Flush face valving
- Seal:** Polyurethane or Nitrite; size dependant

**Features**

- Meets or exceeds ISO 16028 specification design and test requirements.
- Wider size variations and increased pressures.
- ISO-16028 Interface for universal interchangeability.
- Modular design for increased flexibility with fitting port options.
- Brinell relief on male half to increase life and resist wear.
- Induction hardened locking surface to resist brinelling, damage and abuse.
- Heat Treated components to resist scratches and wear.
- Smooth flow path for low pressure drop.
- Heavy locking collar to resist damage and abuse.
- Blow-out resistant seal on male half seal prevents damage and premature failure with residual system pressure.
- Push-to-connect locking mechanism.
- Sleeve lock is a non-standard item.

**Specifications**

Body Size (in.)	1/4	3/8	1/2	5/8	3/4	1
Rated Pressure (PSI)	4568	3625	3625	3625	3625	2900
Rated Flow (GPM)	3	6	12	20	26	50
Temperature Range (std.seals)	-40 to +250° F					
Spillage (ML) (max. per disconnect)	0.015	0.015	0.020	0.030	0.150	0.200
Air Inclusion (ML) (max. per connect)	0.020	0.020	0.070	0.070	0.100	0.150

**Performance**

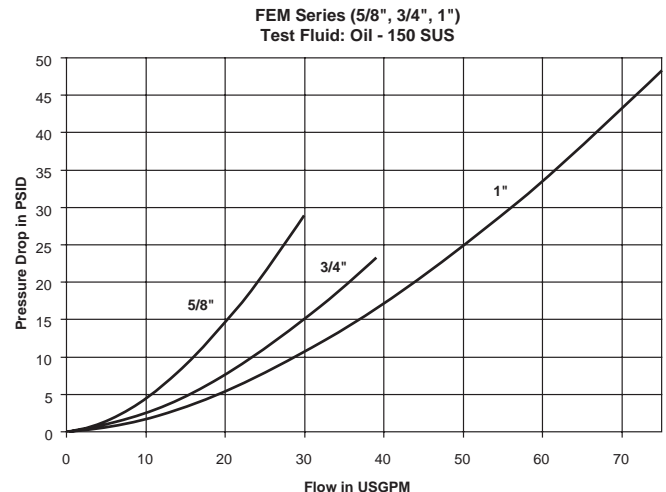
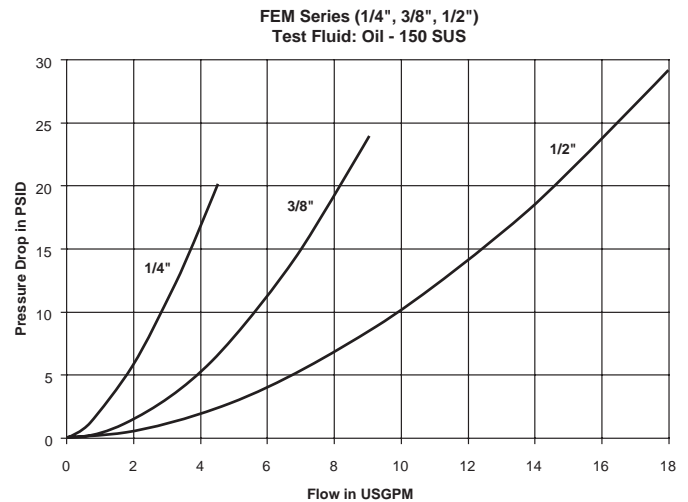

Couplers

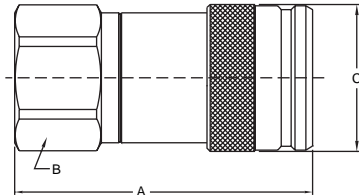
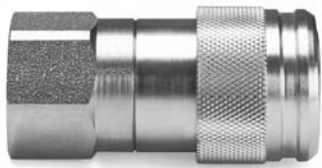

Body Size (in.)	Part Number	Thread Size	Overall Length	Hex Size	Largest Diameter	Wt. (LB) P/Piece
			A	B	C	
1/4	FEM-251-4FP-NL	.250-18 NPSF	1.96	1.00	1.06	0.25
1/4	FEM-251-6FO-NL	.562-18 UNF	2.08	1.00	1.06	0.25
3/8	FEM-371-6FP-NL	.375-18 NPSF	2.89	1.06	1.19	0.51
3/8	FEM-371-8FO-NL	.750-16 UNF	2.89	1.06	1.19	0.51
1/2	FEM-501-8FP-NL	.500-14 NPSF	3.04	1.06	1.58	0.93
1/2	FEM-501-8FO-NL	.750-16 UNF	2.96	1.25	1.58	0.93
1/2	FEM-501-10BMS-NL	1.000-14 UNS	4.02	1.38	1.58	0.95
1/2	FEM-501-10BMF-NL	.875-14 UNF	4.03	1.38	1.58	0.93
1/2	FEM-501-10FO-NL	.875-14 UNF	3.04	1.25	1.58	0.93
1/2	FEM-501-12FO-NL	1.062-12 UN	3.24	1.38	1.58	0.93
5/8	FEM-621-12FO-NL	1.062-12 UNF	3.70	1.50	1.70	1.40
3/4	FEM-751-12FP-NL	.750-14 NPSF	3.95	1.75	1.95	2.04
3/4	FEM-751-12FO-NL	1.062-12 UNF	3.95	1.75	1.95	2.04
1	FEM-1001-16FP-NL	1.000-11.5 NPSF	4.21	2.00	2.25	2.70
1	FEM-1001-16FO-NL	1.312-12 UNF	4.21	2.00	2.25	2.70

Nipples

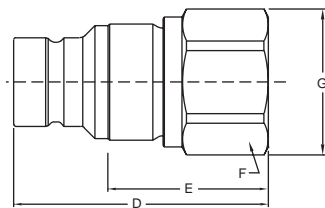

Body Size (in.)	Part Number	Thread Size	Overall Length	Exposed Length*	Hex Size	Largest Diameter	Wt. (LB) P/Piece
			D	E	F	G	
1/4	FEM-252-4FP	.250-18 NPSF	1.71	1.25	1.00	1.06	0.17
3/8	FEM-372-6FP	.375-18 NPSF	2.48	1.83	1.06	1.16	0.32
3/8	FEM-372-8FO	.750-16 UNF	2.48	1.83	1.06	1.16	0.32
1/2	FEM-502-8FP	.500-14 NPSF	2.85	2.15	1.38	1.50	0.54
1/2	FEM-502-10FO	.875-14 UNF	2.85	2.15	1.38	1.50	0.54
1/2	FEM-502-10BMS	1.000-14 UNS	3.84	3.14	1.38	1.50	0.56
1/2	FEM-502-10BMF	.875-14 UNF	3.85	3.15	1.38	1.50	0.54
1/2	FEM-502-12FO	1.062-12 UN	3.05	2.35	1.38	1.50	0.54
5/8	FEM-622-12FO	1.062-12 UN	3.09	2.39	1.50	1.65	0.76
3/4	FEM-752-12FP	.750-14 NPSF	3.38	2.46	1.75	1.94	1.12
3/4	FEM-752-12FO	1.062-12 UN	3.38	2.46	1.75	1.94	1.12
1	FEM-1002-16FP	1.000-11.5 NPSF	3.85	2.93	2.00	2.25	1.72
1	FEM-1002-16FO	1.312-12 UN	3.85	2.93	2.00	2.25	1.72

\* This dimension represents the portion that is exposed when the nipple is inserted into the mating Parker Coupler.

Standard Port Configurations

- FP - Female Pipe Thread
- FO - Female Straight Thread
- BMF - Bulkhead Male Flare 37° JIC
- BMS - Bulkhead Male Seal-lok

Other Fitting Port Configurations available upon request.



### Description

FC Series products operate slightly different from traditional non-spill couplings. With no pressure in the coupler and up to 3000 PSI of trapped pressure in the nipple, begin to couple the mating halves. Delay momentarily during connection to allow trapped pressure to equalize with the mating half before completing the connection.

### Applications

Parker FC Series nipple provides connect-under-pressure capability with up to 3000 PSI of trapped pressure in the nipple and are ideal for applications where residual pressure makes reconnect difficult. Utilized primarily in the construction equipment market, FC Series products are commonly found on hydraulic attachments used in skid steer applications. **The FC Series mates with the FF Series Parker interface.**

### Features

- Connect-Under-Pressure nipple only.
- Hardened locking surface.
- Steel construction, Chromium-6 Free plating for corrosion resistance.
- Blow-out resistant seal in male nipple.
- Flush Face Valving

**Note:** Protective dust plugs and caps play a crucial role in the life of a quick coupling and no purchase of a hydraulic quick coupling is complete without the selection of an appropriate dust plug and cap. See pages noted in Table of Contents for dust plugs and caps for the Parker full line of hydraulic couplings.

### Performance

FC Series (3/8", 1/2", 3/4")  
Test Fluid: Oil - 200 SUS

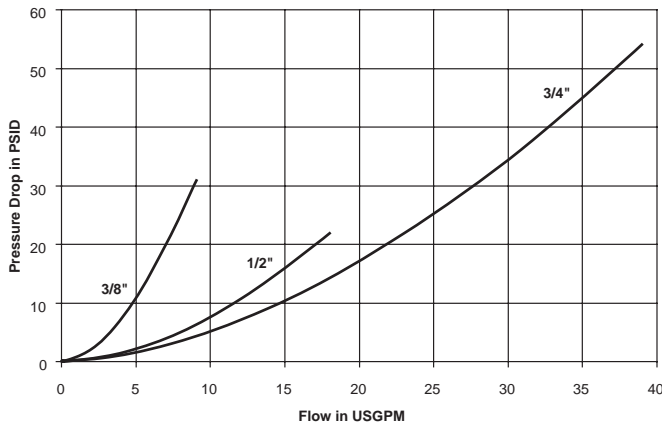

### Specifications

Body Size (in.)	3/8	1/2	3/4
Rated Pressure (PSI)	3000	3000	3000
Rated Connect-Under-Pressure Capability	3000	3000	1500
Rated Flow (GPM)	6	12	26
Spillage (ML) (max. per disconnect)	.015	.020	.015
Air Inclusion (ML) (max. per connect)	.020	.070	.100

### Nipples

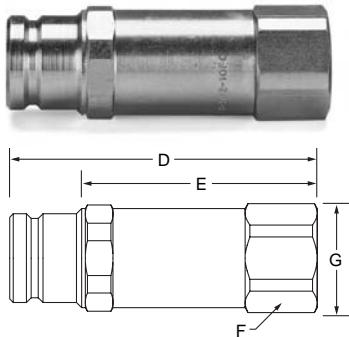

Body Size (in.)	Part No. Steel	Mating Half	Thread Size	Dimensions (in.)				Wt. (LB.) P/Piece
				Overall Length	Exposed Length	Hex Size	Largest Diameter	
				D	E	F	G	
3/8	FC-372-6FP	FF-371	3/8-18 NPSF	3.30	2.58	1.062	1.16	0.45
3/8	FC-372-8FO	FF-371	3/4-16 UNF	3.30	2.58	1.062	1.16	0.42
3/8	FC-372-8FP	FF-371	1/2-14 NPSF	3.30	2.58	1.062	1.16	0.42
1/2	FC-502-8FP	FF-501	1/2-14 NPSF	3.46	2.65	1.125	1.22	0.53
1/2	FC-502-10FO	FF-501	7/8-14 UNF	3.46	2.65	1.125	1.22	0.52
3/4	FC-752-12FO	FF-751	1 1/16-12 UNF	4.81	3.72	1.500	1.65	1.32
3/4	FC-752-12FP	FF-751	3/4-14 NPSF	4.81	3.72	1.500	1.65	1.34

### Standard Port Configurations

- FP - Female Pipe Thread
- FO - Female Straight Thread



### Description

FEC Series products operate slightly different from traditional non-spill couplings. With no pressure in the coupler and up to 3000 PSI of trapped pressure in the nipple, begin to couple the mating halves. Delay momentarily during connection to allow trapped pressure to equalize with the mating half before completing the connection.

### Performance

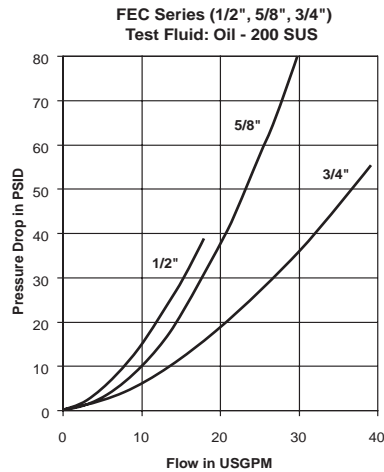

### Applications

Parker FEC Series nipple provide connect-under-pressure capability with up to 3000 PSI of trapped pressure in the nipple and are ideal for applications where residual pressure makes reconnect difficult. Utilized primarily in the construction equipment market, FEC Series products are commonly found on hydraulic attachments used in skid steer applications. **The FEC Series mates with the FEM Series interface ISO 16028 couplers.**

### Features

- Connect-Under-Pressure nipple.
- Hardened locking surface.
- Steel construction, Chromium-6 Free plating for corrosion resistance.
- Anti blowout Nitrile/PTFE bonded nipple seal.
- Flush face valving.

**Note:** Protective dust plugs and caps play a crucial role in the life of a quick coupling and no purchase of a hydraulic quick coupling is complete without the selection of an appropriate dust plug and cap. See pages noted in Table of Contents for dust plugs and caps for the Parker full line of hydraulic couplings.

### Specifications

Body Size (in.)	1/2	5/8	3/4
Rated Pressure (PSI)	3625	3625	3625
Rated Connect-Under-Pressure Capability	3000	1700	1500
Rated Flow (GPM)	12	20	26
Spillage (ML) (max. per disconnect)	0.020	0.03	0.150
Air Inclusion (ML) (max. per connect)	0.070	0.070	0.100

### Nipples

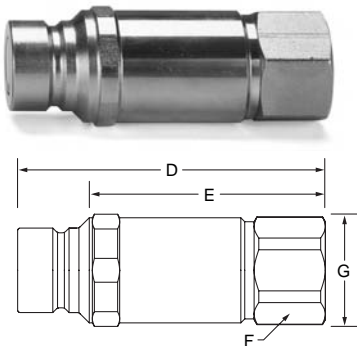

Body Size (in.)	Part No. Steel	Mating Half	Thread Size	Dimensions (in.)				Largest Diameter	Wt. (LB.) P/Piece
				Overall Length	Exposed Length	Hex Size	G		
1/2	FEC-502-8FP	FEM-501	1/2-14 NPSF	3.50	2.68	1.125	1.22		
1/2	FEC-502-10FO	FEM-501	7/8-14 UNF	3.50	2.68	1.125	1.22		
1/2	FEC-502-12FO	FEM-501	1 1/16-12 UNF	3.79	2.97	1.500	1.65		
5/8	FEC-622-12FO	FEM-621	1 1/16-12 UN	4.19	3.39	1.500	1.65		
3/4	FEC-752-12FO	FEM-751	1 1/16-12 UN	4.84	3.76	1.500	1.65		

### Standard Port Configurations

- FP - Female Pipe Thread
- FO - Female Straight Thread



### Description

Parker FH Series high pressure couplings are an innovative product combining the advantages of a flush-face design with a highly technical performance of a rated pressure of 10,000 PSI. For safety purposes, this product does not interchange with flush-face couplings having a lower pressure rating.

### Performance

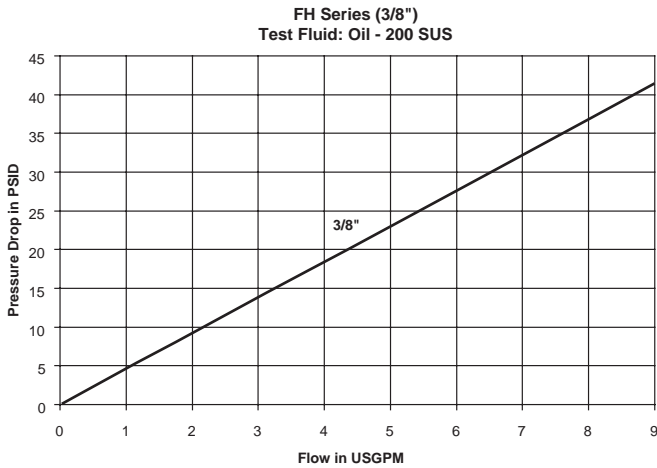

### Features

- 10,000 PSI operating pressure (700 bar).
- Flush face, non-spill valving, both halves.
- Sleeve on coupler and nipple body have a RED finish for identification purposes.
- Simple Push-To-Connect operation.
- Sleeve-Lock to prevent accidental disconnect.
- Non interchangeable with low pressure flush face couplings.
- Meets performance and dimensional specifications of HTMA requirements, 10,000 PSI (700 bar).
- Anti Blow-Out Nitrile/PTFE bonded nipple seal.

### Applications

- Hydraulic Crimpers, Cutters, Jacks, Benders, Clamps, Wedges
- Rescue Equipment
- High Pressure Test Equipment

**Note:** Protective dust plugs and caps play a crucial role in the life of a quick coupling and no purchase of a hydraulic quick coupling is complete without the selection of an appropriate dust plug and cap. See pages noted in Table of Contents for dust plugs and caps for the Parker full line of hydraulic couplings.

### Materials of Construction

- Body:** Steel
- Finish:** Chromium-6 Free plating
- Valve:** Flush Face Valves
- Seal:** Anti blow-out Nitrile/PTFE bonded seal (nipple only)

### Specifications

Body Size (in.)	3/8
Rated Pressure (PSI)	10,000
Rated Flow (GPM)	6
Temperature Range	-40° to +250° F
Spillage (ML) (max. per disconnect)	.020
Air Inclusion (ML) (max. per connect)	.070

## Hydraulic Quick Couplings

## Non-Spill Couplings FH Series

### Couplers

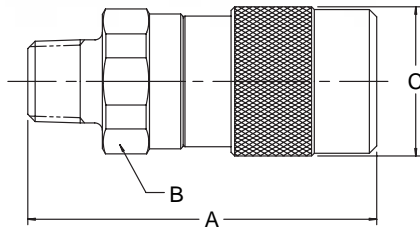

Body Size (in.)	Part No. Steel	Thread Size	Overall Length	Wrench Flats	Dimensions (in.)		Wt. (LB.) P/Piece
					A	B	
3/8	FH-371-6FP	3/8 -18 NPTF	2.63	1.12	1.23	0.44	
3/8	FH-371-6MP	3/8 -18 NPTF	2.85	1.12	1.23	0.45	
3/8	FH-371-6FB	G3/8 -BSPP	2.55	1.12	1.23	0.45	

### Nipples

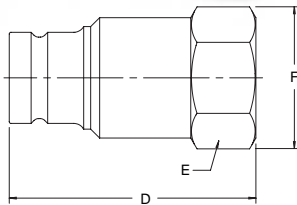

Body Size (in.)	Part No. Steel	Thread Size	Overall Length	Wrench Flats	Dimensions (in.)		Wt. (LB.) P/Piece
					D	E	
3/8	FH-372-6FP	3/8-18 NPTF	2.12	1.00	1.23	0.26	
3/8	FH-372-6FB	G3/8 -BSPP	2.12	1.00	1.23	0.28	

#### Standard Port Configurations

**FP** - Female Pipe Thread

**MP** - Male Pipe Thread

**FB** - Female British Standard Parallel



### Applications

Parker FS Series couplings virtually eliminate fluid loss upon disconnection, and minimize air inclusion during connections. They are ideal for use where spillage may cause undesirable conditions or constitute a safety hazard. The FS Series couplings have double shut-off flush mating valves that are suitable for sealing off media in chemical processing, chemical dispensing, food processing, and other corrosive applications. Working pressures to 2000 PSI.

**Note:** Protective dust plugs and caps play a crucial role in the life of a quick coupling and no purchase of a hydraulic quick coupling is complete without the selection of an appropriate dust plug and cap. See pages noted in Table of Contents for dust plugs and caps for the Parker full line of hydraulic couplings.

### Specifications

Body Size (in.)	1/4	3/8	1/2	3/4	1
Rated Pressure (PSI)	2000	2000	2000	2000	2000
Rated Flow (GPM)	3	6	12	28	50
Spillage (ML) (max. per disconnect)	.015	.015	.020	.150	.250
Air Inclusion (ML) (max. per connect)	.010	.020	.070	.100	.182
CV	0.9	1.8	3.0	7.0	10.1

Temperature Range (continuous)		
Part No. Seal Suffix	Seal Compound	Temp°F Rating
None*	Fluorocarbon	-15 to 400
E5	Ethylene Propylene (EPR)	-65 to 300
E1	Nitrile	-40 to 250
E35	Perfluoroelastomer (Contact Factory)	-20 to 600

\*Fluorocarbon is standard seal.

### Features

- Simple to operate: Push to connect, pull on knurled sleeve to disconnect.
- Flush face valves exhibit minimal spillage upon disconnect and minimal air inclusion upon connect.
- Superior locking ball design – a large number of locking balls distribute the workload better and allow for some rotation between the male and female halves of the coupling under pressure.
- Excellent flow vs pressure drop characteristics when compared with other low spill quick couplings.
- Material construction is 316 stainless steel with fluorocarbon seals as standard.
- Wide range of seal materials available.
- Repair kits available to replace critical elastomer seals (all sizes).

### Materials of Construction

- Machined Parts:** Stainless Steel, AISI type 316
- Springs:** Stainless Steel, AISI type 316.
- Locking Balls:** 1/4" - 302 SS;  
3/8" - 1" - Tungsten Carbide
- Backup Washers:** PTFE
- Elastomer Seals:** Fluorocarbon is standard.  
Wide range is available.

### Performance Flow Data

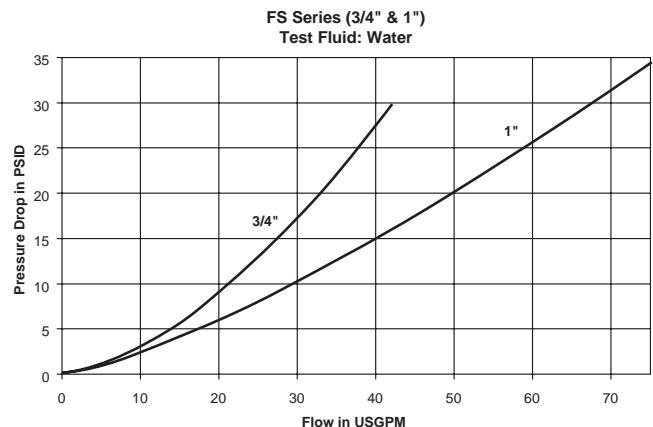
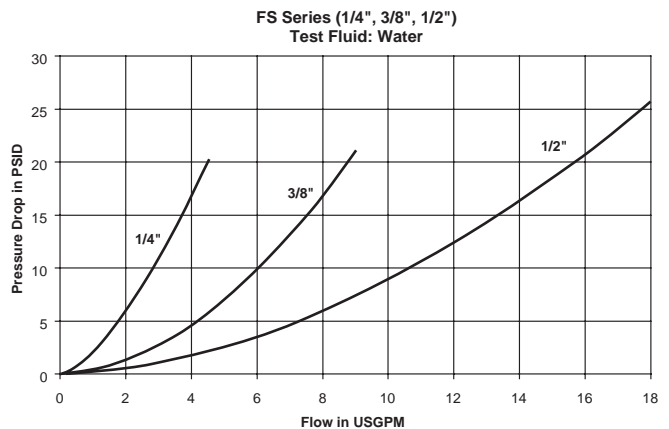

## Hydraulic Quick Couplings

## Non-Spill Couplings FS Series

### Couplers

#### Female Pipe Thread

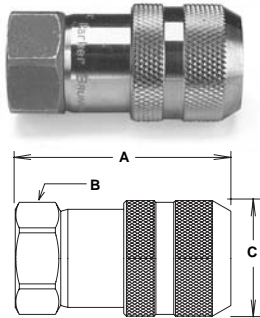

Body Size (in.)	Part No.	Thread Size	Overall Length	Hex Size	Largest Diameter	Wt. (LB.) P/Piece
				A	B	
1/4	FS-251-4FP	1/4-18 NPT	1.79	1.00	1.06	0.25
1/4	FS-251-4MP	1/4-18 NPTF	2.00	1.00	1.06	0.25
1/4	FS-251-6FO	9/16-18UNF	1.92	1.00	1.06	0.24
3/8	FS-371-6FP	3/8-18 NPT	2.52	1.06	1.30	0.58
3/8	FS-371-8FO	3/4-16 UNF	2.83	1.12	1.30	0.63
1/2	FS-501-8FP	1/2-14 NPT	2.74	1.38	1.58	0.92
1/2	FS-501-10FO	7/8-14 UNF	2.86	1.38	1.58	0.96
3/4	FS-751-12FP	3/4-14 NPT	3.63	1.75	1.99	2.00
3/4	FS-751-12FO	1-1/16-12 UNF	3.73	1.75	1.99	2.12
1	FS-1001-16FP	1-11 1/2 NPT	4.14	1.87	2.25	2.76
1	FS-1001-16FO	1-5/16-12 UNF	4.24	1.87	2.25	2.80

### Nipples

#### Female Pipe Thread

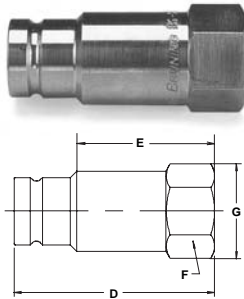

Body Size (in.)	Part No.	Thread Size	Overall Length	Exposed Length	Hex Size	Largest Diameter	Wt. (LB.) P/Piece
			D	E	F	G	
1/4	FS-252-4FP	1/4-18 NPT	1.66	1.14	1.00	1.06	0.18
1/4	FS-252-4MP	1/4-18 NPT	1.87	1.34	1.00	1.06	0.18
1/4	FS-252-6FO	9/16-18 UNF	1.66	1.26	1.00	1.06	0.17
3/8	FS-372-6FP	3/8-18 NPT	2.31	1.71	.94	1.08	0.26
3/8	FS-372-8FO	3/4-16 UNF	2.45	1.71	1.06	1.19	0.30
1/2	FS-502-8FP	1/2-14 NPT	2.75	2.11	1.12	1.30	0.44
1/2	FS-502-10FO	7/8-14 UNF	2.85	2.03	1.12	1.30	0.48
3/4	FS-752-12FP	3/4-14 NPT	3.38	2.47	1.50	1.73	1.02
3/4	FS-752-12FO	1-1/16-12 UNF	3.38	2.27	1.50	1.73	1.14
1	FS-1002-16FP	1-11 1/2 NPT	3.89	2.60	1.87	2.17	1.60
1	FS-1002-16FO	1-5/16 12 UNF	3.89	2.51	1.87	2.17	1.64

#### Standard Port Configurations

- FP - Female Pipe Thread
- MP - Male Pipe Thread
- FO - Female Straight Thread

### FS Series Repair Kits

Repair kits are available for both coupler and nipple half of FS coupling. Kits include replacement elastomer seals, valve assembly and instructions to perform rebuild. Spline tool must be ordered separately to accomplish coupler half repair. Other tools required: Vise, Allen Wrench and Open End Wrench.



FS Repair Kits		Replacement Seals	
TOOL Spline tool for Coupler Repair	No Suffix	Fluorocarbon Seals	
	E5	Ethylene Propylene (EPR)	
	E35	Perfluoroelastomer (Contact the Factory)	

#### Nipple Repair Kits

1/4" Nipple	3/8" Nipple	1/2" Nipple	3/4" Nipple	1" Nipple
FS-252-KIT	FS-372-KIT	FS-502-KIT	FS-752-KIT	FS-1002-KIT
FS-252-KIT-E5	FS-372-KIT-E5	FS-502-KIT-E5	FS-752-KIT-E5	FS-1002-KIT-E5

#### Coupler Repair Kits

1/4" Coupler	3/8" Coupler	1/2" Coupler	3/4" Coupler	1" Coupler
N/A	FS-371-KIT	FS-501-KIT	FS-751-KIT	FS-1001-KIT
N/A	FS-371-KIT-E5	FS-501-KIT-E5	FS-751-KIT-E5	FS-1001-KIT-E5
N/A	FF/FS-371-TOOL	FS-501-TOOL	FF/FS-751-TOOL	FF/FS-1001-TOOL



### Applications

Parker's 6100 Series, is a thread-to-connect low spill coupling that can be used in a wide range of industrial applications where connected under pressure is required. The 6100 is ideal for connecting hydraulic lines on oil field equipment like power tongs, swivels and mobile drilling rigs. It is also widely used on dump trailers to connect the tractor to wet-line hydraulic systems.

The 6100 Series is suitable for many applications where high flow connect under pressure couplings are required. Other uses include: submersible pumps, engine test stands, and bulk liquid CO2 transfer (Special part numbers apply – contact the Division).

**Note:** Protective dust plugs and caps play a crucial role in the life of a quick coupling and no purchase of a hydraulic quick coupling is complete without the selection of an appropriate dust plug and cap. See pages noted in Table of Contents for dust plugs and caps for the Parker full line of hydraulic couplings.

### Specifications

Body Size (in.)	3/4	3/4	1	1-1/4	1-1/2
Dash Number	-08	-12	-16	-20	-24
*Rated Pressure (PSI)					
Female Half	3000	3000	3000	2750	2000
Male Half	3000	3000	3000	2500	2500
Complete Coupling Assembly	3000	3000	3000	2750	2500
Rated Flow (GPM)	12	28	50	76	100
Temperature Range (std seals)	-40° to +250°F.				

\* Minimum burst pressure is equal to three times the rated pressure. Not recommended for continuous hydraulic impulse applications at rated pressures.

### Performance

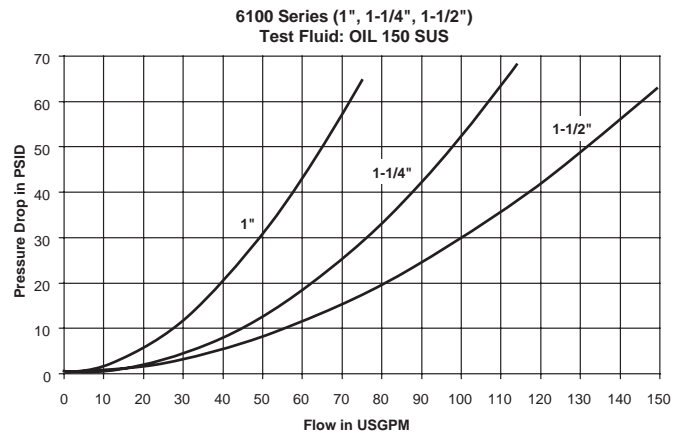
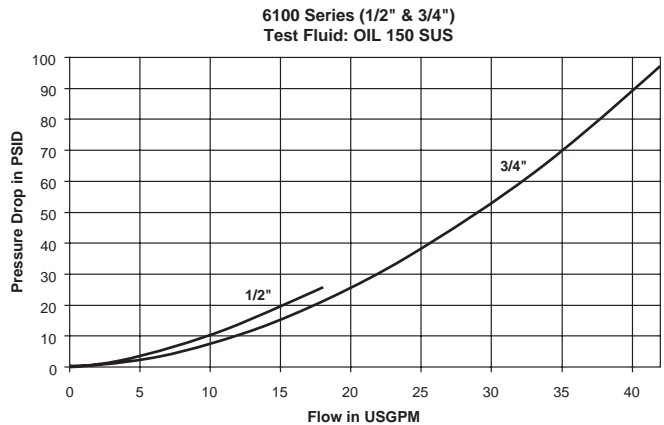

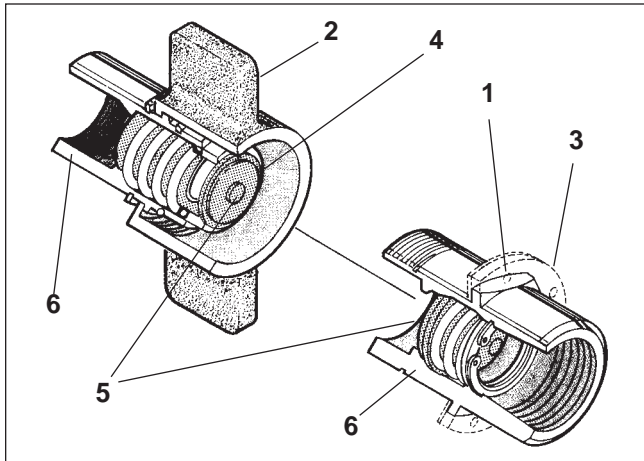

**Features**

1. The connection indicator, a Parker innovation, serves as a visual check for complete connection of the 6100 coupling. It helps prevent premature failures and leaks. It assures that the connection is complete and the valves fully open, eliminating unnecessary flow restriction. (see drawing on next page)
2. The Parker heavy-duty wing nut is ruggedly built specifically to withstand the hammer blows commonly used to tighten and loosen this coupler.
3. The flange is designed to give a positive “no-slip” bulkhead mounting to reduce downtime.
4. The bonded valve seal permits full pressure connect and disconnect—without seal washout.
5. The flush face valve keeps air inclusion and spillage to a minimum.
6. Corrosion resistant brass body makes this coupling compatible with a broad range of media and provides versatility.

**6100 Series**

**Coupling with Wingnut**

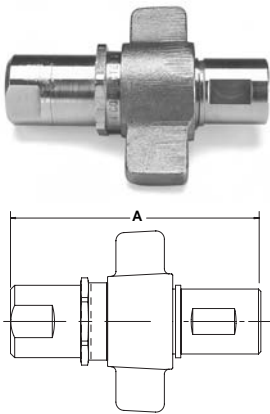

Body Size (in.)	Thread Size NPTF	Part No. With Flange	Part No. Without Flange	Overall Connected Length	Wt. (LB.) P/Piece
<b>A</b>					
3/4	1/2-14	6100-08	6120-08	5.20	2.12
3/4	3/4-14	6100-12	6120-12	5.20	3.27
1	1-11 1/2	6100-16	6120-16	5.99	3.19
1 1/4	1 1/4-11 1/2	6100-20	6120-20	6.33	2.73
1 1/2	1 1/2-11 1/2	6100-24	6120-24	6.55	3.52

**6100 Series**

**Coupling with Hex Nut**

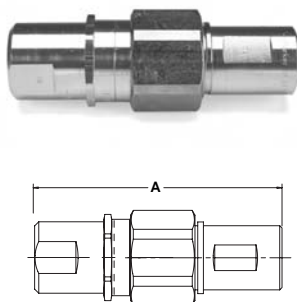

Body Size (in.)	Thread Size NPTF	Part No. With Flange	Part No. Without Flange	Overall Connected Length	Wt. (LB.) P/Piece
<b>A</b>					
3/4	1/2-14	6110-08	6130-08	5.20	1.89
3/4	3/4-14	6110-12	6130-12	5.20	1.83
1	1-11 1/2	6110-16	6130-16	5.99	2.93
1 1/4	1 1/4-11 1/2	6110-20	6130-20	6.33	4.12
1 1/2	1 1/2-11 1/2	6110-24	6130-24	6.55	5.95

# Hydraulic Quick Couplings

# Connect Under Pressure Couplings 6100 Series

## Couplers

### Wing Nut

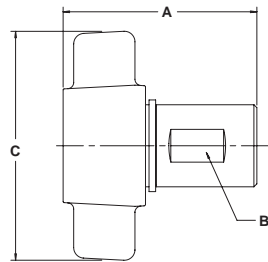

Body Size (in.)	Part No. Brass	Thread Size NPTF	Dimensions (in.)			Wt. (LB.) P/Piece
			Overall Length	Wrench Flats	Wing Nut	
			A	B	C	
3/4	6125-08	1/2-14	3.22	1.16	4.06	1.30
3/4	6125-12	3/4-14	3.22	1.16	4.06	1.26
1	6125-16	1-11 1/2	3.87	1.43	4.38	1.89
1 1/4	6125-20	1 1/4-11 1/2	4.16	1.78	5.20	2.84
1 1/2	6125-24	1 1/2-11 1/2	4.34	2.00	5.32	3.72

### Hex Nut

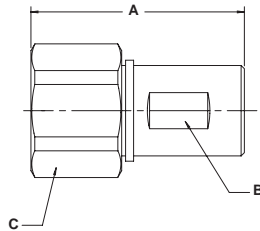

Body Size (in.)	Part No. Brass	Thread Size NPTF	Dimensions (in.)			Wt. (LB.) P/Piece
			Overall Length	Wrench Flats	Hex Size	
			A	B	C	
3/4	6135-08	1/2-14	3.22	1.16	1.75	1.07
3/4	6135-12	3/4-14	3.22	1.16	1.75	1.07
1	6135-16	1-11 1/2	3.87	1.43	2.13	1.63
1 1/4	6135-20	1 1/4-11 1/2	4.16	1.78	2.50	2.47
1 1/2	6135-24	1 1/2-11 1/2	4.34	2.00	2.75	3.15

### Nipples

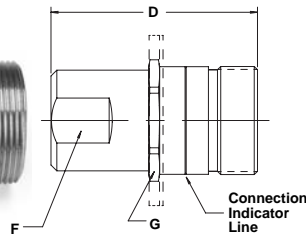

Body Size (in.)	Part No. Without Flange Brass	With Flange Brass	Thread Size NPTF	Dimensions (in.)			Wt. (LB.) P/Piece
				Overall Length	Hex Size	Wrench Flats	
				D	G	F	
3/4	6105-08	6115-08	1/2-14	3.11	1.62	1.18	0.82
3/4	6105-12	6115-12	3/4-14	3.11	1.62	1.18	0.76
1	6105-16	6115-16	1-11 1/2	3.55	1.88	1.56	1.30
1 1/4	6105-20	6115-20	1 1/4-11 1/2	3.71	2.13	1.88	1.65
1 1/2	6105-24	6115-24	1 1/2-11 1/2	4.12	2.50	2.18	2.61

### Flanges

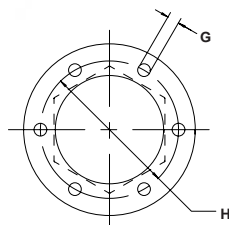

Body Size (in.)	Part No. Steel	Dimensions (in.)	
		Bolt Hole Diameter	Bolt Circle Diameter
		G	H
3/4	6107-08 (1 piece)	.208	2.125
1	6107-16 (1 piece)	.208	2.375
1 1/4	6107-20 (2 piece)	.208	2.625
1 1/2	6107-24 (2 piece)	.281	3.250



### Applications

The 8200 Series brings to the industry a proven design for use on construction equipment, forestry equipment, agricultural machinery, oil tools, steel mill machinery, and other demanding hydraulic applications.

**Note:** Protective dust plugs and caps play a crucial role in the life of a quick coupling and no purchase of a hydraulic quick coupling is complete without the selection of an appropriate dust plug and cap. See pages noted in Table of Contents for dust plugs and caps for the Parker full line of hydraulic couplings.

### Special Order Information

Standard seal material is Nitrile, other seal options are available. See Ordering Information at end of Section B and Fluid Compatibility Chart at end of this catalog for assistance in making seal selection.

### Features

Parker 8200 Series couplings feature:

- Unique valve design permits connection while either or both the coupler and nipple are under pressure.
- Double acting sleeve for one handed push-to-connect operation when coupler is clamp or bulkhead mounted.
- Critical parts are hardened for durability.
- Dependable ball locking mechanism holds the mating halves together.
- Couplers and nipples are precision machined from solid bar stock.
- The mating 8010 series nipples meet ISO 5675 requirements.

### Specifications

Body Size (in.)	1/2
Rated Pressure (PSI)	3000
Rated Flow (GPM)	12
Temperature Range (std seals)	-40° to +250°F

### Performance

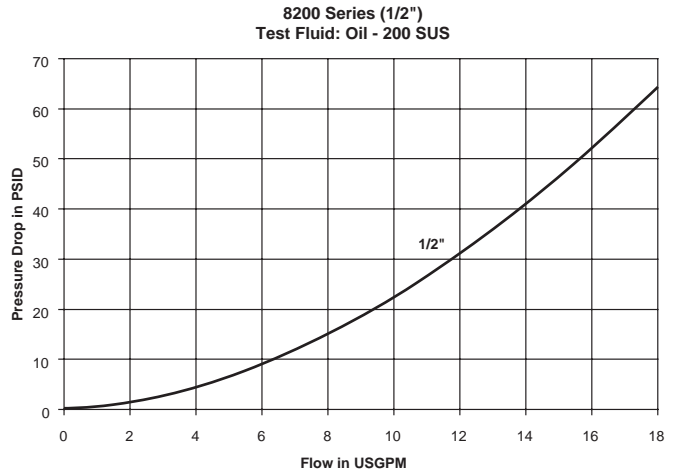

## Couplers

### Female Thread

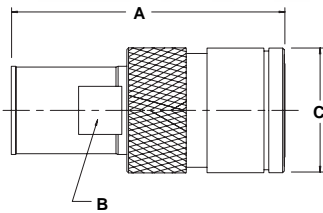

Body Size (in.)	Part No. Steel	Thread Size NPSF	Thread Size ORB	Dimensions (in.)			Wt. (LB.) P/Piece
				Overall Length	Wrench Flats	Largest Diameter	
				A	B	C	
1/2	8250-4	1/2-14	–	3.29	0.87	1.50	0.63
1/2	8250-15	–	3/4-16	3.29	0.87	1.50	0.63
1/2	8250-16	–	7/8-14	3.29	0.87	1.50	0.63

## Nipples

### Female Thread

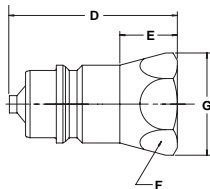

Body Size (in.)	Part No. Steel	Thread Size NPTF	Thread Size ORB	Dimensions (in.)				Wt. (LB.) P/Piece
				Overall Length	Exposed Length	Hex Size	Largest Diameter	
				D	E	F	G	
1/2	8010-4	1/2-14	–	1.95	1.09	1.06	1.23	0.20
1/2	8010-4P*	1/2-14	–	1.95	1.09	1.06	1.23	0.20
1/2	8010-15	–	3/4-16	2.06	1.20	1.06	1.23	0.20
1/2	8010-15P*	–	3/4-16	2.06	1.20	1.06	1.23	0.20
1/2	8010-16	–	7/8-14	2.05	1.18	1.06	1.23	0.25
1/2	8010-16P*	–	7/8-14	2.05	1.18	1.06	1.23	0.25

\* Poppet design

## Replacement Parts - 8200 Series

Body Size (in.)	Part Number	Description	Material
1/2	50005-211-0202	Q-Ring	Nitrile



### Applications

The Parker 9200 lever coupling is designed with a lever-operated cam that opens and closes the valves in both coupling halves, positively locking them into place. This allows the couplings to be easily connected and disconnected while under pressure. The 9200 couplings can functionally replace a Double Shut-Off quick coupling and two high pressure ball valves. By simply turning the lever to the “closed” position the hydraulic lines on a piece of machinery or mobile equipment may be disconnected either for maintenance or equipment changeovers.

**Note:** Protective dust plugs and caps play a crucial role in the life of a quick coupling and no purchase of a hydraulic quick coupling is complete without the selection of an appropriate dust plug and cap. See pages noted in Table of Contents for dust plugs and caps for the Parker full line of hydraulic couplings.

### Performance

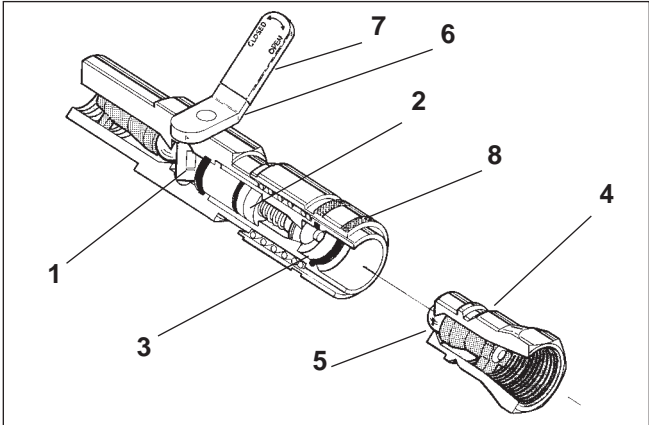
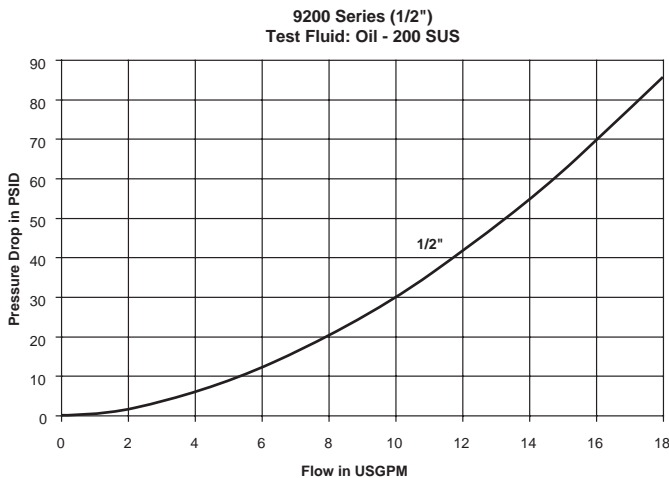

### Features

1. The lever operates a cam that mechanically locks both valves into either the “open” or “closed” position.  
 “Closed,” the flow is shut off at the coupler, allowing easy zero-pressure connect and disconnect.  
 “Open,” the valves are locked in the open position in both coupler and nipple. In this position the valves are unaffected by hydraulic surges.
2. Parker design eliminates back flow-checking. The positive lock of the cam prevents hydraulic surges from forcing the valve closed, which avoids flow checking and disrupting equipment performance.
3. Valves close automatically if coupling is accidentally disconnected.
4. The 8010 Series nipples used with the 9200 coupler is an industry standard that meets ISO 5675 requirements.
5. Rugged, reliable ball valve and induction hardened locking ball groove prevent Brinelling and prolong coupling life.
6. Turning the lever without the nipple in place will NOT result in oil flow.
7. The Lever Coupler is covered by patent numbers: #3680591 and #4009729.
8. New easy action sleeve aids connect and disconnect.

### Specifications

Body Size (in.)	1/2
Rated Pressure (PSI)	3000
Rated Flow (GPM)	12
Temperature Range (std seals)	-40° to +250° F

# Hydraulic Quick Couplings

# Connect Under Pressure Couplings 9200 Series

## Couplers

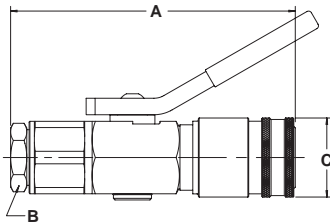

Body Size (in.)	Part No. Steel	Thread Size NPTF	Dimensions (in.)		Overall Length	Wrench Flats	Largest Diameter	Wt. (LB.) P/Piece	
			ORB						
					A	B	C		
1/2	9250-4-320	1/2-14	—		5.37	1.13	1.50	2.02	
1/2	9250-6-320	—	9/16-18		5.37	1.13	1.50	2.04	
1/2	9250-15-320	—	3/4-16		5.37	1.13	1.50	2.06	
1/2	9250-16-320	—	7/8-14		5.37	1.13	1.50	1.98	
*1/2	9250-334	—	9/16-18		5.37	1.13	1.50	2.15	

\* Mates with the 1/4" 60 Series Nipples.

## Nipples

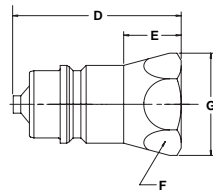

Body Size (in.)	Part No. Steel	Thread Size NPTF	Thread Size ORB	Overall Length	Dimensions (in.)				Wt. (LB.) P/Piece	
					Exposed Length	Hex Size	Largest Diameter			
					D	E	F	G		
1/2	8010-4	1/2-14	—	1.95	1.09	1.06	1.23	0.20		
1/2	8010-4P*	1/2-14	—	1.95	1.09	1.06	1.23	0.20		
1/2	8010-15	—	3/4-16	2.06	1.20	1.06	1.23	0.20		
1/2	8010-15P*	—	3/4-16	2.06	1.20	1.06	1.23	0.20		
1/2	8010-16	—	7/8-14	2.05	1.18	1.06	1.23	0.25		
1/2	8010-16P*	—	7/8-14	2.05	1.18	1.06	1.23	0.25		

\* Poppet design

## Replacement Parts

### 9200 Series

Body Size (in.)	1/2
O-Rings - Nitrile	50001-211-0260



**Applications**

The Parker 5000 Series is an economical coupling that is a threaded union and can be connected under pressure with tools. For applications that require a coupling to be connected under-pressure and where tools can be used to make the connection, the 5000 Series coupling should be considered.

**Note:** Protective dust plugs and caps play a crucial role in the life of a quick coupling and no purchase of a hydraulic quick coupling is complete without the selection of an appropriate dust plug and cap. See pages noted in Table of Contents for dust plugs and caps for the Parker full line of hydraulic couplings.

**Specifications**

Body Size (in.)	1/2
Rated Pressure (PSI)	2500
Rated Flow (GPM)	12
Temperature Range (std seals)	-40° to +250°F

**Features**

The Parker 5000 Series coupling features:

- Two-piece coupler body that permits operation while one or both halves are under pressure as well as when there is no pressure in either half.
- Connect under pressure by unscrewing the valve body until two or three threads are visible.
- Nipple can be inserted and locked into the coupler without opening either valve. (Use a wrench to thread the valve body back into the coupler, the valves are opened against internal pressure. If internal pressure makes manual disconnect difficult, unscrewing the valve body from the coupler will permit the valves to close, thereby relieving internal pressure and allowing manual operation of the ball-locking sleeve.)
- The mating 8010 series nipples meet ISO 5675 requirements.

**Performance**

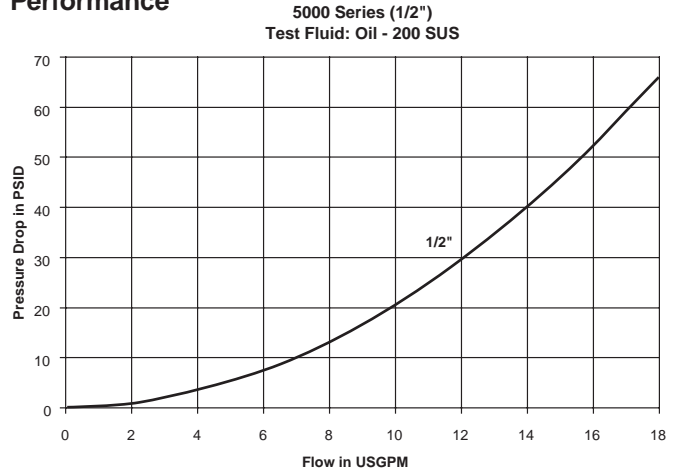

# Hydraulic Quick Couplings

## Connect Under Pressure Couplings 5000 Series

### Coupler



Body Size (in.)	Part No. Steel	Thread Size NPTF	Overall Length	Dimensions (in.)				Largest Diameter	Wt. (LB.) P/Piece
				Length	Wrench Flats	Wrench Flats			
			A	B	C	D	E		
1/2	5050-4	1/2-14	2.88	2.32	1.06	1.25	1.52	2.58	

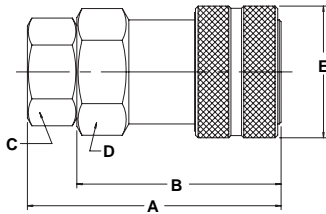

### Nipple



Body Size (in.)	Part No. Steel	Thread Size NPTF	Dimensions (in.)					Largest Diameter	Wt. (LB.) P/Piece
			ORB	Overall Length	Exposed Length	Hex Size			
				D	E	F	G		
1/2	8010-4	1/2-14	—	1.95	1.09	1.06	1.23	0.20	
1/2	8010-15	—	3/4-16	2.06	1.20	1.06	1.23	0.20	
1/2	8010-16	—	7/8-14	2.05	1.18	1.06	1.23	0.20	

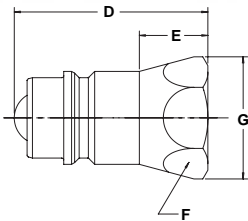

### Replacement Parts 5000 Series

Body Size (in.)	1/2
O-Rings - Nitrile	50001-211-0260

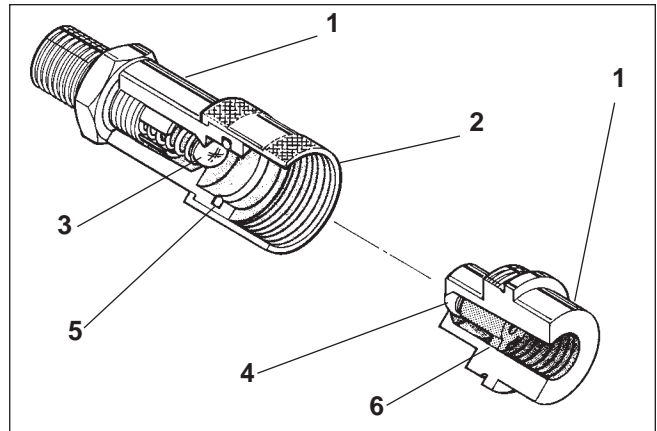

### Applications

Parker 3000 Series couplings with their threaded union locking system and precision ball-type check valves, are designed for extreme high pressure applications such as found on portable hydraulic rams. See pages noted in Table of Contents for dust plugs and caps for the Parker full line of hydraulic couplings.

**Note:** Protective dust plugs and caps play a crucial role in the life of a quick coupling and no purchase of a hydraulic quick coupling is complete without the selection of an appropriate dust plug and cap. See pages noted in Table of Contents for hydraulic couplings dust plugs and caps for the full line of hydraulic couplings.

### Specifications

Body Size (in.)	1/4	3/8
Rated Pressure (PSI) Static	10,000	10,000
Rated Flow (GPM)	3	6
Temperature Range (std seals)	-22° to +230°F	

### Features

1. Machined from solid steel barstock for durability.
2. The 3000 Series employs a threaded sleeve locking mechanism, mates with matching male threads on the nipple. The two halves must be manually threaded together for connection.
3. Hard, chrome alloy balls are used for valving. They are spring loaded for positive seating of the valve.
4. The valve provides a metal-to-metal seal between the ball and a coined seat.
5. The interface seal is polyurethane which resists high pressure extrusion.
6. A threaded valve retainer provides a valve stop that assures positive valve alignment.

### Performance

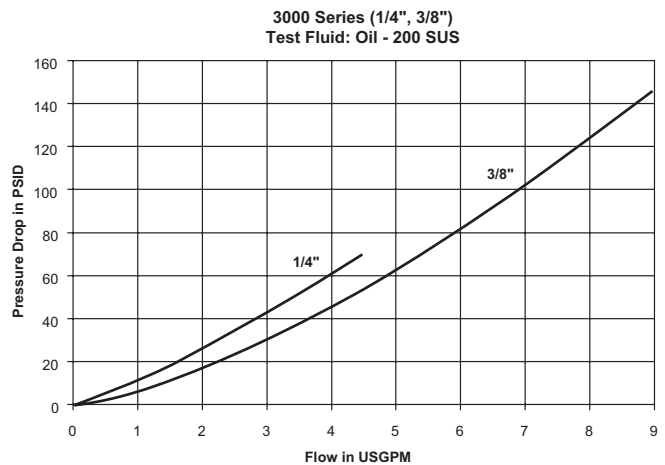

Couplers

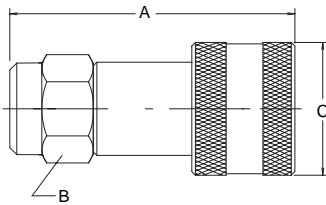

Body Size (in.)	Part No.	Thread Size NPTF	Dimensions (in.)			Wt. (LB.) P/Piece
			Overall Length	Wrench Flats	Largest Diameter	
			A	B	C	
1/4	3050-2	1/4-18 (Male)	2.38	0.81	1.13	0.25
3/8	3050-3	3/8-18 (Male)	2.88	1.00	1.38	0.49
3/8	3050-3-231	3/8-18 (Female)	2.82	1.00	1.38	0.49

Nipples

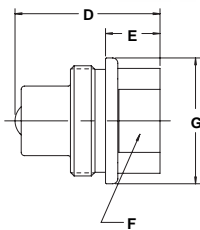

Body Size (in.)	Part No. Steel	Thread Size NPTF	Overall Length	Dimensions (in.)			Largest Diameter	Wt. (LB.) P/Piece
				Expose Length	Hex Size			
			D	E	F	G		
1/4	3010-2	1/4-18 (Female)	1.29	0.48	0.75	1.13	0.14	
3/8	3010-3	3/8-18(Female)	1.58	0.50	0.94	1.25	0.23	
3/8	3010-3-230	3/8-18 (Male)	2.31	1.23	1.00	1.25	0.30	



### Specifications

Body Size (in.)	3/8
Rated Pressure (PSI)	10,000
Rated Flow (GPM)	6
Temperature Range (std seals)	-15° to +400°F

### Performance

TC Series (3/8")  
Test Fluid: Oil - 200 SUS

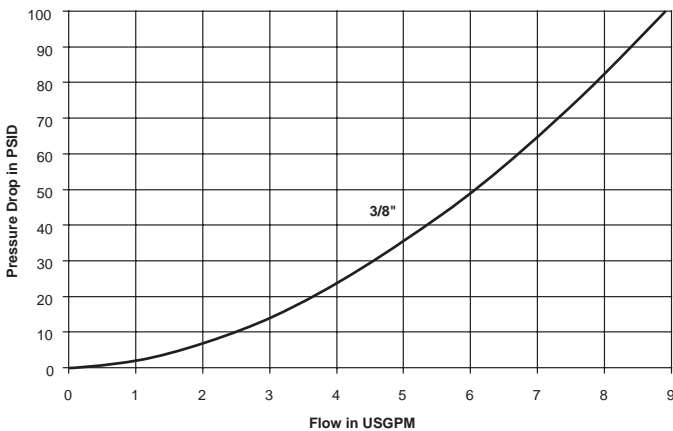

### Features

- Positive valve stop. The perch maintains valve alignment and provides metal to metal valve stop to insure that the valves open full—every time.
- Precision machined valves with elastomeric seals provide for positive shut-off upon disconnection.
- Hardened nipples and sleeves and solid barstock construction make for a quality coupling with maximum resistance to damage from hydraulic and mechanical shock.
- Durable ball-locking mechanism assures reliable connection every time. A large number of locking balls distributes the work load evenly while providing alignment and swiveling action to reduce hose torque and prolong hose life. CAUTION: These products are not to be used as swivels, rotation under pressure will result in excessive and premature wear.
- Female pipe (NPSF) standard.
- The standard Fluorocarbon seal is designed to withstand extremely high pressures and provide reliable sealing. PTFE back-up ring provides support for the seal in high pressure applications.
- Sleeve locking mechanism prevents accidental disconnection when the coupling is dragged along the ground.
- Steel construction, Chromium-6 Free plating for corrosion resistance.

### Applications

Parker TC series couplings are found in the construction, railway maintenance and house moving industries. Used on hydraulic jacking equipment, these couplers eliminate costly down time caused by improperly connected threaded types. For use where high pressure capability is required coupled with positive coupling action. Considerably faster to use than threaded types.

**Note:** Protective dust plugs and caps play a crucial role in the life of a quick coupling and no purchase of a hydraulic quick coupling is complete without the selection of an appropriate dust plug and cap. See pages noted in Table of Contents for dust plugs and caps for the Parker full line of hydraulic couplings.

### Coupler

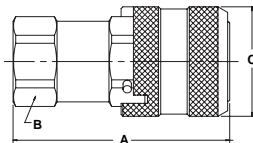

Body Size (in.)	Part No.	Fitting Thread Size	Dimensions (in.)			Wt. (LB.) P/Piece
			Overall Length	Hex Size	Largest Diameter	
			A	B	C	
3/8	TC-371	3/8-18 NPSF	2.48	0.94	1.25	0.43

### Nipple

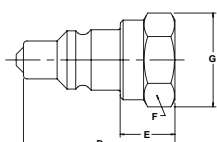

Body Size (in.)	Part No.	Fitting Thread Size	Dimensions (in.)				Wt. (LB.) P/Piece
			Overall Length	Exposed Length	Hex Size	Largest Diameter	
			D	E	F	G	
3/8	TC-372	3/8-18 NPSF	1.82	0.66	0.94	1.08	0.14

NPSF – National Pipe Straight Fuel



### Applications

The 1141 Series is a general purpose coupling for high pressure connect-under-pressure applications.

### Features

- 303 Stainless steel body.
- Brass locking sleeve
- Polyurethane seals to resist extrusion and abrasion.
- Self locking threads help prevent coupling from accidentally disconnecting.
- Visual makeup – when fully coupled the edge of the sleeve will be flush with the end of the male thread – giving a visual check for complete coupling.
- Small diameter mating seal helps keep separation forces to a minimum, allowing for easier connect and disconnect at pressures up to 5,000 PSI.
- 10,000 PSI working pressure, 17,000 PSI intermittent pressure.
- Dust caps and plugs included.

### Specifications

<b>Body Size (in.)</b>	<b>1/4</b>
Rated Pressure (PSI)	10,000
Rated Connect-Under-Pressure Capability (PSI)	5000
Rated Flow (GPM)	3
Temperature Range (Polyurethane seals)	-30° to +180°F
Vacuum test	20 in/Hg
Torque to connect at 1000 PSI	47 in/lbs.

### Coupler

Body Size (in.)	Part No.	Thread Size NPTF	Dimensions (in.)		Wt. (LB.) P/Piece
			A	B	
1/4	1141-62	1/4-18	2.75	1.00	0.40

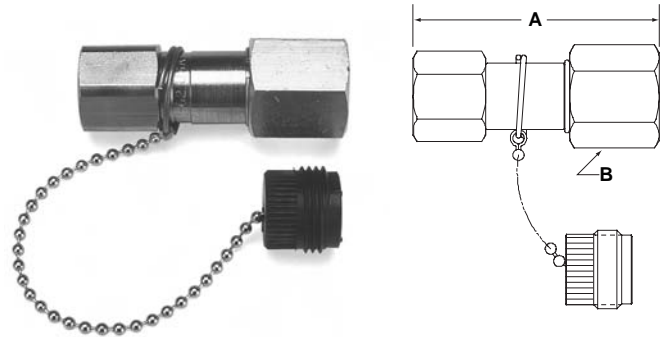

### Nipple

Body Size (in.)	Part No.	Thread Size NPTF	Dimensions (in.)		Wt. (LB.) P/Piece
			C	D	
1/4	1141-63	1/4-18	2.00	.88	0.26

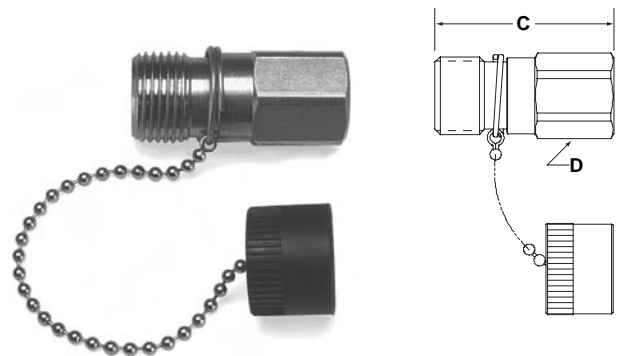



**Selection Guidelines**

Moldmate couplings are designed for a maximum working pressure of 200 PSI. Most thermoplastic and thermoset heat transfer systems have pumps which provide relatively high flow rates at relatively low pressures. Water and water glycol systems usually have capacities ranging from 10 to 40 gpm, with most from 10 to 15 gpm. Normal medial opening pressures are 20 to 60 PSI for these systems. Heat transfer systems using oil generally operate from 10 to 30 PSI. However, their flow rates are usually much higher, requiring the total volume of oil to be circulated at least once per minute.

The number of hose connections in a single mold system results in a cumulative pressure drop. Please note the Pressure Drop vs. Flow Rate chart provided, to select the appropriate size.

Temperature is another important consideration. Parker moldmate couplings with their standard Silicone seal have a temperature capability of -90° to +400°F. Rapid deterioration of the seal and leakage may result if used beyond these limits.

External conditions of temperature, corrosive atmospheres, and other abnormalities may affect coupling performance and must be considered when selection is made. Consult factory with questions.

**Applications**

Parker moldmate couplings are specifically designed for connecting coolant lines to molds and dies, on injection molding machinery in the plastics and die casting industries. Moldmate couplings significantly reduce machine downtime by providing fast and easy connection of coolant lines during mold changes. Their short nipples can be recessed below the surface of the mold for more efficient storage of molds. Moldmate couplers are available with or without valves in the female half. Non-valved couplers provide maximum flow for efficient cooling. Valved couplers shut off when disconnected.

**Special Order Information**

Standard seal material is Silicone and is compatible with water and water glycol fluids commonly used in heat transfer systems. Fluorocarbon seals are available for use only with oil-based media and not with water glycol. To specify a Fluorocarbon seal, add the suffix "Y" to the standard moldmate part number, thus: PC206Y.

**Specifications**

Body Size (in.)	1/4	3/8	1/2
Rated Pressure (PSI)	200	200	200
Rated Flow (GPM)	3	6	12

Material	Temperature Range
Standard Silicone seal	-90° to +400°F
*Optional Fluorocarbon seal	-15° to +400°F

\* For use with oil based media only

**Performance**

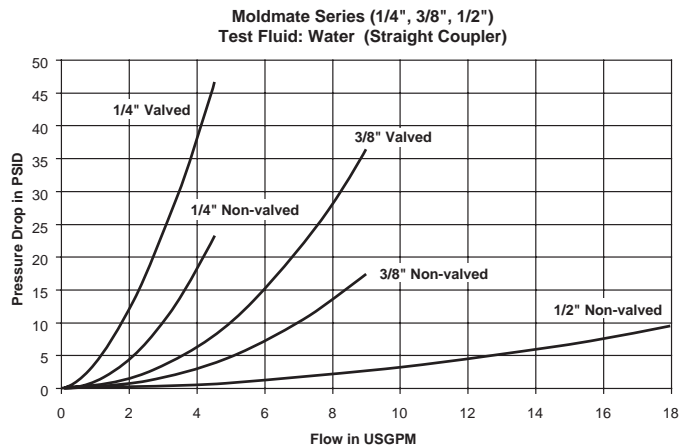

## Hydraulic Quick Couplings

## Mold Coolant Line Couplings

Moldmate Series

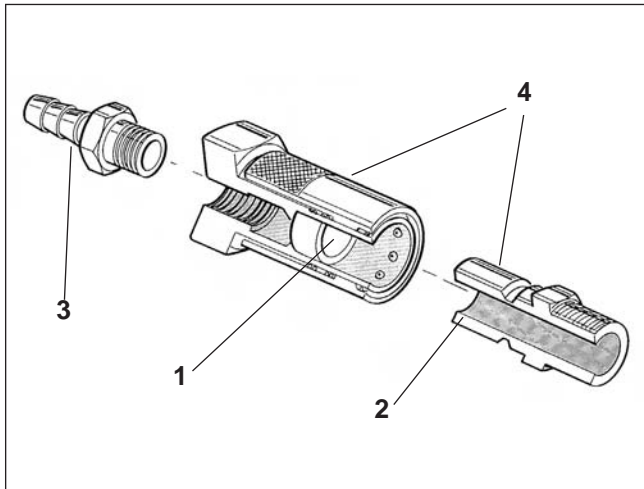

### Features

1. Available with or without valves in the coupler. Non-valved couplers have minimum flow resistance for maximum cooling. Valved couplers shut off automatically upon disconnect. Valved couplers can be used with either valved or non-valved nipples. A valved nipple, however, must be used with a valved coupler.
2. Nipples are designed to be recessed below mold surfaces to provide more efficient storage of molds and prevent damage to the nipple.
3. Widest choice of end fittings available, including straight, 45° or 90° with standard hose barb or Push-Lok barbs for easy installation.
4. Couplers and nipples are made of corrosion resistant brass, and valved couplers or valved nipple have a Fluorocarbon O-ring on poppet and Silicone interface seal as standard for use with water glycol type fluids commonly used in heat transfer systems.
5. Silver colored sleeve designates valved coupler.

### Couplers

#### Straight

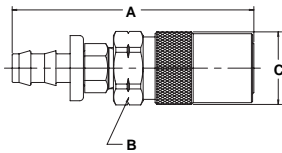

#### 45 Degree

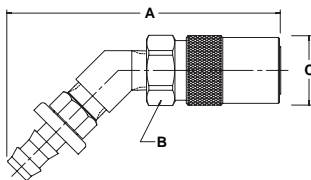

Body Size (in.)	Part No. Brass Non-valved	Wt. (LB.) P/Piece	Part No. Brass Valved	Wt. (LB.) P/Piece	Hose I.d.	Dimensions (in.)					
						Overall Length	Largest Diameter		Overall Length	Hex Size Diameter	
							Non-valved A	C		Valved A	B
1/4	PC204	0.10	PC204AV	0.10	1/4	1.87	0.63	0.63	2.67	0.63	0.71
1/4	PC204-BP*	0.10	PC204AV-BP	0.10	1/4	1.89	0.63	0.63	2.52	0.63	0.71
1/4	PC205	0.09	PC205AV	0.10	5/16	1.87	0.63	0.63	2.67	0.63	0.71
1/4	PC206	0.09	PC206AV	0.10	3/8	1.87	0.63	0.63	2.67	0.63	0.71
1/4	PC206-BP*	0.11	PC206AV-BP	0.13	3/8	2.04	0.63	0.63	2.70	0.63	0.71
3/8	PC306	0.24	PC306V	0.27	3/8	3.01	0.96	0.96	3.17	0.88	1.01
3/8	PC306-BP*	0.26	PC306V-BP	0.29	3/8	3.15	0.96	0.96	3.31	0.88	1.01
3/8	PC308	0.25	PC308V	0.28	1/2	3.15	0.96	0.96	3.17	0.88	1.01
3/8	PC308-BP*	0.25	PC308V-BP	0.03	1/2	3.27	0.96	0.96	3.43	0.88	1.01
1/2	PC504	0.46	NA	-	1/2	3.55	1.30	1.30	-	-	-
1/2	PC504-BP*	0.50	NA	-	1/2	3.68	1.21	1.21	-	-	-
1/2	PC506	0.48	NA	-	3/4	3.80	1.21	1.21	-	-	-
1/2	PC506-BP*	0.52	NA	-	3/4	3.80	1.21	1.21	-	-	-

NA = Not Available

Body Size (in.)	Part No. Brass Non-valved	Wt. (LB.) P/Piece	Part No. Brass Valved	Wt. (LB.) P/Piece	Hose I.D.	Dimensions (in.)						
						Overall Length	Hex Size	Largest Diameter		Overall Length	Hex Size	Largest Diameter
								Non-valved A	B			
1/4	PC224	0.13	PC224AV	0.13	1/4	2.67	0.56	0.71	0.71	2.87	0.63	0.71
1/4	PC224-BP*	0.13	PC224AV-BP	0.14	1/4	2.57	0.56	0.71	0.71	2.77	0.63	0.71
1/4	PC226	0.13	PC226AV	0.14	3/8	2.71	0.56	0.71	0.71	2.91	0.63	0.71
1/4	PC226-BP*	0.26	PC226AV-BP	0.17	3/8	2.74	0.56	0.71	0.71	2.94	0.63	0.71
3/8	PC326	0.36	PC326V	0.36	3/8	3.65	0.88	0.96	0.96	3.65	0.88	1.01
3/8	PC326-BP*	0.34	PC326V-BP	0.36	3/8	3.75	0.88	0.96	0.96	3.75	0.88	1.01
3/8	PC328	0.36	PC328V	0.36	1/2	3.69	0.88	0.96	0.96	3.69	0.88	1.01
3/8	PC328-BP*	0.34	PC328V-BP	0.40	1/2	3.88	0.88	0.96	0.96	3.88	0.88	0.96
1/2	PC524	0.74	NA	-	1/2	4.18	1.12	1.21	1.21	-	-	-
1/2	PC524-BP*	0.78	NA	-	1/2	4.28	1.12	1.21	1.21	-	-	-
1/2	PC526	0.76	NA	-	3/4	4.56	1.12	1.21	1.21	-	-	-
1/2	PC526-BP*	0.80	NA	-	3/4	4.56	1.12	1.21	1.21	-	-	-

\* Suffix BP in part number denotes Push-Lok hose barb. Without suffix denotes standard hose barb.

Push-Lok hose barbs are designed for use with Parker Push-Lok hose and do not require clamps.

Valved Couplers can be used with either non-valved or valved nipples.

# Hydraulic Quick Couplings

# Mold Coolant Line Couplings Moldmate Series

## 90 Degree

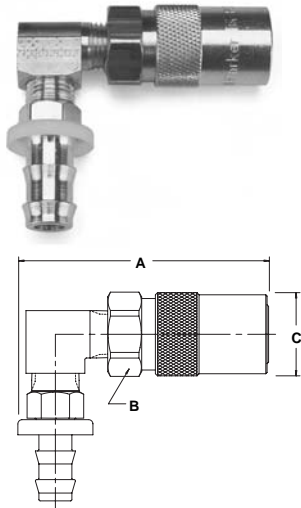

Body Size (in.)	Part No. Brass Non-valved	Wt. (LB.) P/Piece	Part No. Brass Valved	Wt. (LB.) P/Piece	Hose I.D.	Dimension (in.)			Dimensions (in.)		
						Overall Length	Hex Size	Largest Diameter	Overall Length	Hex Size	Largest Diameter
						Non-valved			Valved		
						A	B	C	A	B	C
1/4	PC214	0.13	PC214AV	0.14	1/4	1.78	0.56	0.71	1.98	0.63	0.71
1/4	PC214-BP*	0.14	PC214AV-BP	0.14	1/4	1.78	0.56	0.71	1.98	0.63	0.71
1/4	PC215	0.13	PC215AV	0.14	5/16	1.78	0.56	0.71	1.98	0.63	0.71
1/4	PC216	0.14	PC216AV	0.15	3/8	1.78	0.56	0.71	1.98	0.63	0.71
1/4	PC216-BP*	0.16	PC216AV-BP	0.17	3/8	1.80	0.56	0.71	2.00	0.63	0.71
3/8	PC316	0.31	PC316V	0.31	3/8	2.78	0.88	0.96	2.78	0.88	0.96
3/8	PC316-BP*	0.37	PC316V-BP	0.37	3/8	2.78	0.88	0.96	2.78	0.88	0.96
3/8	PC318	0.33	PC318V	0.35	1/2	2.78	0.88	0.96	2.78	0.88	0.96
3/8	PC318-BP*	0.37	PC318V-BP	0.39	1/2	2.80	0.88	0.96	2.80	0.88	0.96
1/2	PC514	0.79	NA	-	1/2	3.50	1.12	1.21	-	-	-
1/2	PC514-BP*	0.83	NA	-	1/2	3.50	1.12	1.21	-	-	-
1/2	PC516	0.80	NA	-	3/4	3.50	1.12	1.21	-	-	-
1/2	PC516-BP*	0.84	NA	-	3/4	3.50	1.12	1.21	-	-	-

\* Suffix BP in part number denotes Push-Lok hose barb. Without suffix denotes standard hose barb. Push-Lok hose barbs are designed for use with Parker Push-Lok hose and do not require clamps. Valved Couplers can be used with either non-valved or valved nipples.

## Sub Assemblies and Individual Replacement Parts

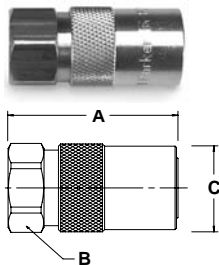

### Non-valved Sub-assembly (Brass Sleeve)

Body Size (in.)	Part No. Brass For No-valving	Wt. (LB.) P/Piece	Thread Size NPTF	Dimensions (in.)		
				Overall Length	Hex Size	Largest Diameter
				A	B	C
1/4	P208-01A	0.07	1/8-27	1.15	0.56	0.71
3/8	P308-01A	0.21	1/4-18	1.84	0.88	0.96
3/8	P308-01A-HF	0.20	3/8-18	1.84	0.88	0.96
1/2	PC500	0.34	1/2-14	2.02	1.12	1.21

### Valved\* Sub-assembly (Silver Colored Sleeve)

Body Size (in.)	Part No. Brass For Valving	Wt. (LB.) P/Piece	Thread Size NPTF	Dimensions (in.)		
				Overall Length	Hex Size	Largest Diameter
				A	B	C
1/4	P201-01A	0.07	1/8-27	1.35	0.56	0.71
3/8	P301-01A	0.21	1/4-18	1.84	0.88	0.96

\*Bodies are designed for use with valves retained by a male pipe fitting (i.e. hose barb). Order valves and valve springs separately.

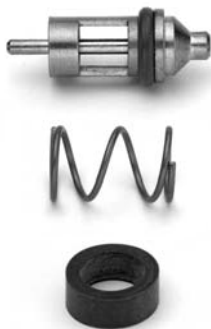

### Valves (for Valved Sub-assembly)

Body Size (in.)	Part No.	Material
1/4	3613001	Brass
3/8	P300-11S	Brass

### Valve Springs (for Valved Sub-assembly)

Body Size (in.)	Part No.	Material
1/4	7820123	Stainless
3/8	P300-6	Stainless

### Replacement Seals (for both Valved and Non-valved)

Seal Material	Body Size (in.) 1/4	Body Size (in.) 3/8	Body Size (in.) 1/2
* Silicone	P200-9A	P300-9A	P500-9A
* Fluorocarbon	P200-9AY	P300-9AY	—

\* Please note: Bulk seals are considered to be non-returnable.

### Assembly Instruction Sheet (for all sizes & configurations)

Order Part Number 9090065



# Hydraulic Quick Couplings

# Mold Coolant Line Couplings

Moldmate Series

## Nipples

### Female Pipe Thread

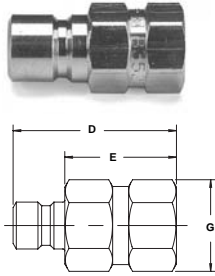

Body Size (in.)	Part No. Brass	Wt. (LB.) P/Piece Brass	Part No. Steel	Wt. (LB.) P/Piece Steel	Thread Size NPTF	Dimensions (in.)			
						Overall Length	**Exposed Length	Hex Size	Largest Diameter
						D	E	F	G
1/4	BPN251F	0.02	PN251F	0.02	1/8-27	0.97	0.58	0.50	0.58
1/4	BPN252F	0.05	PN252F	0.04	1/4-18	1.28	0.89	0.63	0.72
1/4	BPN253F	0.08	PN253F	0.08	3/8-18	1.41	1.02	0.75	0.87
3/8	BPN352F	0.05	PN352F	0.05	1/4-18	1.48	0.88	0.63	0.72
3/8	BPN353F	0.07	PN353F	0.06	3/8-18	1.58	0.98	0.75	0.87

### Male Pipe Thread

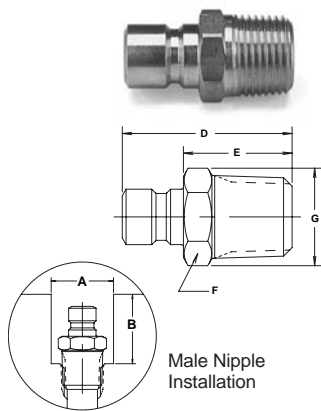

Body Size (in.)	Part No. Brass	Wt. (LB.) P/Piece Brass	Part No. Steel	Wt. (LB.) P/Piece Steel	Thread Size NPTF	Dimensions (in.)				Installation	
						Overall Length	**Exposed Length	Hex Size	Largest Dia.	Recess Dia.	Depth
						D	E	F	G	A	B
1/4	PN250	0.02	-	-	1/16-27	0.94	0.54	0.44	0.51	0.69	0.69
1/4	PN251	0.02	PN251S	0.02	1/8-27	0.94	0.54	0.44	0.51	0.69	0.69
1/4	PN252	0.03	PN252S	0.03	1/4-18	1.13	0.74	0.56	0.67	0.84	0.94
1/4	PN253	0.05	PN253S	0.05	3/8-18	1.19	0.79	0.69	0.79	1.00	0.94
3/8	PN352	0.04	PN352S	0.04	1/4-18	1.34	0.74	0.56	0.65	1.00	1.09
3/8	PN353	0.06	PN353S	0.06	3/8-18	1.38	0.78	0.69	0.79	1.00	1.13
3/8	PN354	0.12	NA	-	1/2-14	1.59	0.99	0.88	1.01	1.19	1.25
1/2	PN553	0.12	NA	-	3/8-18	1.53	0.77	0.88	1.01	1.25	1.34
1/2	PN554	0.11	NA	-	1/2-14	1.70	0.94	0.88	1.01	1.25	1.50
1/2	PN556	0.16	NA	-	3/4-14	1.75	0.99	1.06	1.23	1.50	1.56

### Valved Nipple

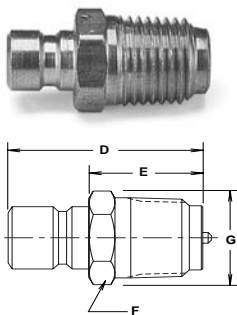

Body Size (in.)	Part No. Brass	Thread Size NPTF	Overall Length	**Exposed Length	Dimensions (in.)			Installation		Wt. (LB.) P/Piece
					Hex Size	Largest Dia.	Recess Dia.	Depth		
			D	E	F	G	A	B		
1/4	BPV252*	1/4-18	1.21	0.82	.56	0.67	0.84	0.94	0.03	
3/8	BPV353*	3/8-18	1.48	0.88	.69	0.79	1.00	1.23	0.07	

\*Valved Nipple must be used with Valved Coupler.

\*\*This dimension represents the portion of the nipple that is exposed when inserted into a moldmate coupler.

Moldmate Extension Nipples

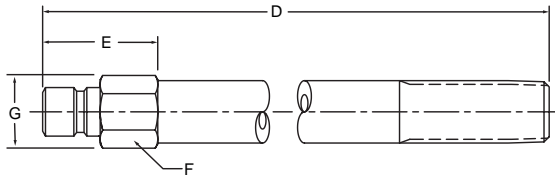

Body Size (in.)	Part No. Brass	Thread Size NPTF	Overall Length	Dimensions (in.)				Wt. (LB.) P/Piece
				D	E	F	G	
1/4	PN250-25	1/16-27	2.50	.69	3/8	0.43	0.04	
1/4	PN250-40	1/16-27	4.00	.81	3/8	0.43	0.06	
1/4	PN250-55	1/16-27	5.50	.81	3/8	0.43	0.09	
1/4	PN251-25	1/8-27	2.50	.69	7/16	0.51	0.06	
1/4	PN251-40	1/8-27	4.00	1.00	7/16	0.51	0.10	
1/4	PN251-55	1/8-27	5.50	1.00	7/16	0.51	0.13	
1/4	PN251-70	1/8-27	7.00	1.00	7/16	0.51	0.17	
1/4	PN251-85	1/8-27	8.50	1.00	7/16	0.51	0.21	
1/4	PN252-25	1/4-18	2.50	.88	9/16	0.65	0.09	
1/4	PN252-40	1/4-18	4.00	1.25	9/16	0.65	0.15	
1/4	PN252-55	1/4-18	5.50	1.25	9/16	0.65	0.22	
1/4	PN252-70	1/4-18	7.00	1.25	9/16	0.65	0.27	
1/4	PN252-85	1/4-18	8.50	1.25	9/16	0.65	0.33	
3/8	PN351-25	1/8-27	2.50	.88	9/16	0.65	0.07	
3/8	PN351-40	1/8-27	4.00	1.00	9/16	0.65	0.11	
3/8	PN351-55	1/8-27	5.50	1.00	9/16	0.65	0.15	
3/8	PN351-70	1/8-27	7.00	1.00	9/16	0.65	0.18	
3/8	PN351-85	1/8-27	8.50	1.00	9/16	0.65	0.22	
3/8	PN352-25	1/4-18	2.50	.88	9/16	0.65	0.09	
3/8	PN352-40	1/4-18	4.00	1.25	9/16	0.65	0.15	
3/8	PN352-55	1/4-18	5.50	1.25	9/16	0.65	0.21	
3/8	PN352-70	1/4-18	7.00	1.25	9/16	0.65	0.27	
3/8	PN352-85	1/4-18	8.50	1.25	9/16	0.65	0.33	
3/8	PN353-25	3/8-18	2.50	1.00	11/16	0.79	0.12	
3/8	PN353-40	3/8-18	4.00	1.25	11/16	0.79	0.20	
3/8	PN353-55	3/8-18	5.50	1.25	11/16	0.79	0.28	
3/8	PN353-70	3/8-18	7.00	1.25	11/16	0.79	0.37	
3/8	PN353-85	3/8-18	8.50	1.25	11/16	0.79	0.45	

B Hydraulics



### Applications

The Parker ST Series are non-valved couplings for applications where maximum flow is required. Their smooth, open bore offers the lowest pressure drop of any quick coupling design and is ideal for applications such as high-pressure water and steam washers, carpet cleaners and mold coolant lines and many other non-valved applications.

### Specifications

Body Size (in.)	1/8	1/4	3/8	1/2	3/4	1	1 1/4	1 1/2
Rated Pressure (PSI)								
Brass Cplr/Npl	2500	5200	2700	2200	1700	1200	1700	1400
Brass Cplr/Steel Npl	2600	5500	3500	2700	2700	2000	-	-
SS Cplr/Npl	4200	6700	5500	3000	3000	1700	-	-
Rated Flow	3	6	12	12	28	50	76	100
Temperature Range (std seals)	-40° to +250°F							

### Performance

ST Series (1/8", 1/4", 3/8", 1/2")  
Test Fluid: Oil - 150 SUS

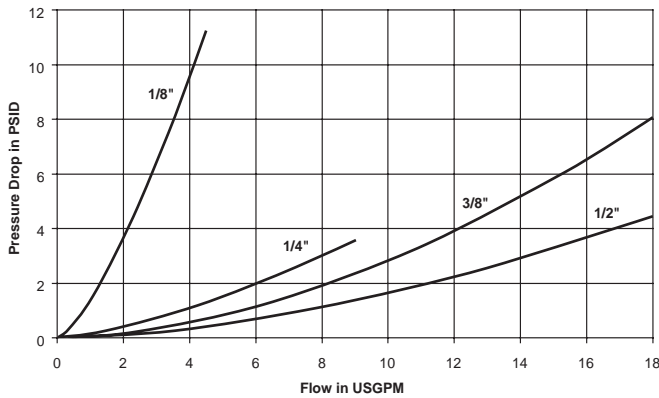

ST Series (3/4", 1", 1-1/4")  
Test Fluid: Oil - 150 SUS

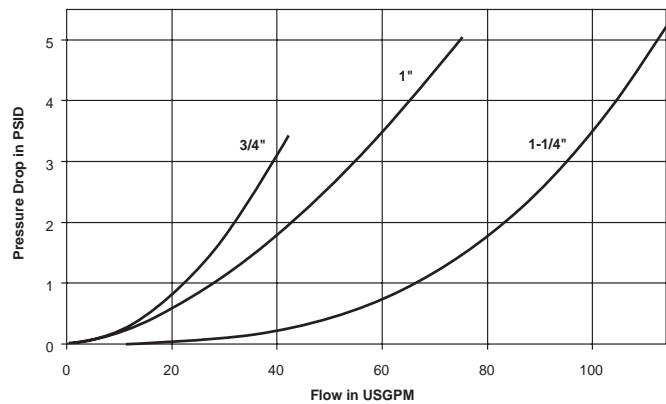

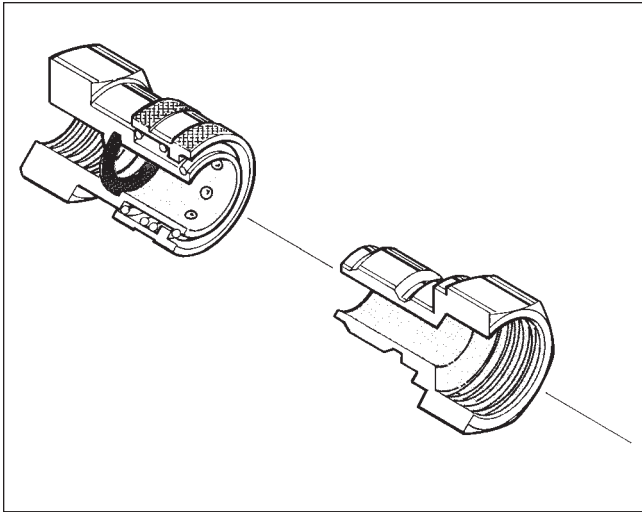

**Features**

- The smooth, open bore with no valving in either half offers minimal pressure drop and allows easy cleaning in applications where the same lines are used for more than one media.
- ST couplers and nipples are machined from solid barstock, providing a quality coupling that is durable. ST couplers are available in brass and 303 stainless steel as standard product materials.
- ST nipples are available in 303 stainless steel, brass and Chromium-6 Free plated steel. The ball locking grooves of the steel ST nipples are case hardened for resistance to brinelling where high cycle rates and pressure surges are encountered.
- The ST is an "Interchange" coupling since it dimensionally and functionally interchanges with similar couplings made by other manufacturers.

**Special Order Information**

All sizes of ST Series can be furnished with locking sleeves. Place suffix letters "SL" (Sleeve-Lok) after regular catalog numbers. Example: SST-4MSL. Standard seal material is Nitrile. Ethylene Propylene, Fluorocarbon, or Neoprene seals are available upon request. See Fluid Compatibility Chart for recommendations.

**Couplers**

**Female Pipe Thread**

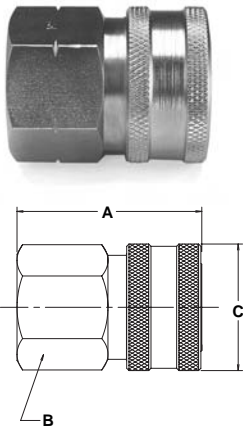

Body Size (in.)	Part No.		Part No.		Thread Size NPTF	Dimensions (in.)		
	Brass	Wt. (LB.) P/Piece	Type 303 Stainless	Wt. (LB.) P/Piece		Overall Length	Wrench Flats	Largest Diameter
						A	B	C
1/8	BST-1	0.06	SST-1	0.05	1/8-27	1.06	0.56	0.69
1/4	BST-2	0.17	SST-2	0.15	1/4-18	1.54	0.81	0.94
3/8	BST-3	0.26	SST-3	0.24	3/8-18	1.59	1.00	1.16
1/2	BST-4	0.59	SST-4	0.37	1/2-14	1.98	1.13	1.30
3/4	BST-6	0.62	SST-6	0.57	3/4-14	2.15	1.44	1.66
1	BST-8	0.99	SST-8	0.93	1-11 1/2	2.43	1.75	2.02
1-1/4	BST-10	1.38	-	-	1 1/4-11 1/2	2.44	2.00	2.51
1-1/2	BST-12	1.42	-	-	1 1/2-11 1/2	2.88	2.50	3.00

**Male Pipe Thread**

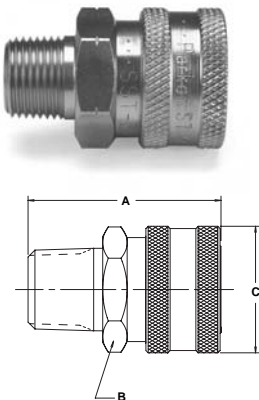

Body Size (in.)	Part No.		Part No.		Thread Size NPTF	Dimensions (in.)		
	Brass	Wt. (LB.) P/Piece	Type 303 Stainless	Wt. (LB.) P/Piece		Overall Length	Wrench Flats	Largest Diameter
						A	B	C
1/8	BST-1M	0.05	SST-1M	0.05	1/8-27	1.06	0.56	0.69
1/4	BST-2M	0.16	SST-2M	0.16	1/4-18	1.69	0.81	0.81
3/8	BST-3M	0.25	SST-3M	0.21	3/8-18	1.75	1.00	1.16
1/2	BST-4M	0.34	SST-4M	0.31	1/2-14	1.94	1.13	1.30
3/4	BST-6M	-	SST-6M	0.49	3/4-14	2.17	1.44	1.66
1	BST-8M	0.85	SST-8M	0.08	1-11 1/2	2.53	1.75	2.02

## Hydraulic Quick Couplings

## High Flow Couplings ST Series

### Nipples

#### Female Pipe Thread

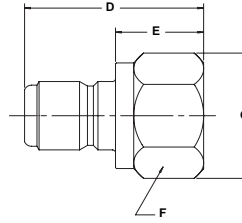

Body Size (in.)	Part No. Brass	Wt. (LB.) P/Piece	Part No. Steel	Wt. (LB.) P/Piece	Part No. Type 303 Stainless	Wt. (LB.) P/Piece	Thread Size NPTF	Dimensions (in.)			
								Overall Length	Exposed Length	Hex Size	Largest Dia.
								D	E	F	G
1/8	BST-N1	0.03	ST-N1	0.03	SST-N1	0.02	1/8-27	.98	0.57	0.56	0.65
1/4	BST-N2	0.07	ST-N2	0.07	SST-N2	0.07	1/4-18	1.46	0.74	0.75	0.87
3/8	BST-N3	0.12	ST-N3	0.11	SST-N3	0.11	3/8-18	1.62	0.96	.088	1.59
1/2	BST-N4	0.23	ST-N4	0.21	SST-N4	0.21	1/2-14	1.85	0.95	1.13	1.30
3/4	BST-N6	0.33	ST-N6	0.32	SST-N6	0.32	3/4-14	2.15	1.09	1.38	1.59
1	BST-N8	0.52	ST-N8	0.49	SST-N8	0.48	1-11 1/2	2.35	1.18	1.63	1.88
1 1/4	BST-N10	0.85	-	-	-	-	1 1/4-11 1/2	2.38	1.11	2.00	2.31
1 1/2	BST-N12	1.45	-	-	-	-	1 1/2-11 1/2	2.81	1.17	2.38	2.74

### Nipples

#### Male Pipe Thread

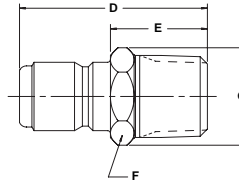

Body Size (in.)	Part No. Brass	Wt. (LB.) P/Piece	Part No. Steel	Wt. (LB.) P/Piece	Part No. Type 303 Stainless	Wt. (LB.) P/Piece	Thread Size NPTF	Dimensions (in.)			
								Overall Length	Exposed Length	Hex Size	Largest Dia.
								D	E	F	G
1/8	BST-N1M	0.02	ST-N1M	0.02	SST-N1M	0.02	1/8-27	1.04	0.63	0.44	0.51
1/4	BST-N2M	0.06	ST-N2M	0.05	SST-N2M	0.05	1/4-18	1.53	0.81	0.56	0.65
3/8	BST-N3M	0.08	ST-N3M	0.07	SST-N3M	0.08	3/8-18	1.69	0.86	0.69	0.79
1/2	BST-N4M	0.15	ST-N4M	0.13	SST-N4M	0.13	1/2-14	1.94	1.01	0.88	1.01
3/4	BST-N6M	0.23	ST-N6M	0.21	SST-N6M	0.22	3/4-14	2.19	1.11	1.06	1.23
1	BST-N8M	0.46	ST-N8M	0.43	SST-N8M	0.43	1-11 1/2	2.51	1.34	1.38	1.59
1 1/4	BST-N10M	0.96	-	-	-	-	1 1/4-11 1/2	2.85	1.60	1.88	2.17
1 1/2	BST-N12M	1.46	-	-	-	-	1 1/2-11 1/2	3.25	1.59	2.13	2.45

## Replacement Parts

### ST Series

ST Series O-Rings	Body Size (in.)			
	1/8	1/4	3/8	1/2
Standard Nitrile*	50001-010-0010	50001-110-0010	50001-112-0010	50001-114-0010

ST Series O-Rings	Body Size (in.)			
	3/4	1	1-1/4	1-1/2
Standard Nitrile*	50001-212-0010	50001-217-0010	50001-221-0010	50001-327-0010

\* Other compounds available are Ethylene Propylene, Fluorocarbon, Neoprene (Contact the division for compound availability)



#### Applications

Parker Water Service Couplings are used anywhere water hoses are connected and disconnected frequently. They are used on a wide variety of applications including garden hoses, wash down systems, and mobile water tank lines. The unvalved design permits maximum flow with minimum pressure drop.



#### Specifications

Body Size (in.)	3/4"
Rated Pressure (PSI)	200
Rated Flow (GPM)	28
Temperature Range (std seals)	-40°F to +250°F

#### Features

- Brass and stainless steel construction for heavy duty service.
- Durable 4-ball locking mechanism for secure connections.
- Quality, temperature-resistant Nitrile seals for a leak-free service life.

#### Coupler

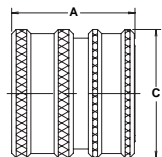

Body Size (in.)	Part No.	Thread Size NH	Overall Length A	Largest Diameter C	Wt. (LB.) P/Piece
3/4	1163-60	3/4-11 1/2	1.16	1.21	0.12

#### Nipple

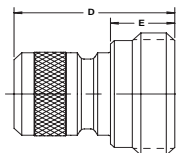

Body Size (in.)	Part No.	Thread Size NH	Overall Length D	Exposed Length E	Wt. (LB.) P/Piece
3/4	1163-61	3/4-11 1/2	1.25	.50	0.08



### Specifications

Body Size (in.)	1/4	3/8	1/2
Rated Pressure (PSI)	15,000	15,000	10,000
Rated Flow (GPM)	3	6	12
Temperature Range (std seals)	-40° to +250°F		

### Applications

HO Series couplings are used in a wide variety of applications. HO couplings are used in refineries, petrochemical plants and paper and pulp mills for connecting hose lines for high pressure hydro-blasting of boilers and pipe lines. They are also used in oil fields on hose lines for internal and external pressure testing of tubing.

**Note:** Protective dust plugs and caps play a crucial role in the life of a quick coupling and no purchase of a hydraulic quick coupling is complete without the selection of an appropriate dust plug and cap. See pages noted in Table of Contents for hydraulic couplings dust plugs and caps for the full line of hydraulic couplings.

### Features

- For high pressure applications: working pressures to 15,000 PSI (1,050 Bar) for the 1/4" and 3/8" sizes; to 10,000 PSI (700 Bar) for the 1/2" size.
- No internal valving to restrict flow.
- Made of steel with electroless nickel plating for corrosion resistance.
- Standard sleeve-lock feature which helps prevent accidental disconnect.
- Standard Nitrile Body O-Ring. Backed up by PTFE washer to prevent seal extrusion.

### Couplers

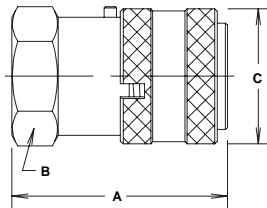
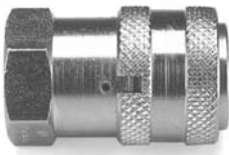

Body Size (in.)	Part No.	Thread Size NPSF	Dimensions (in.)			Largest Diameter	Wt. (LB.) P/Piece
			Overall Length	Hex Size			
			A	B	C		
1/4	HO-251-4FP	1/4-18	1.67	0.94	1.06	0.24	
3/8	HO-371-6FP	3/8-18	1.67	0.94	1.06	0.22	
1/2	HO-501-8FP	1/2-14	2.03	1.25	1.62	0.52	

### Nipples

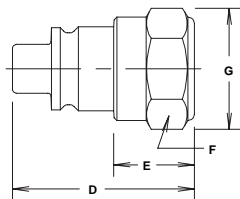

Body Size (in.)	Part No.	Thread Size NPSF	Dimensions (in.)				Largest Diameter	Wt. (LB.) P/Piece
			Overall Length	Exposed Length	Hex Size			
			D	E	F	G		
1/4	HO-252-4FP	1/4-18	1.40	0.66	0.81	0.94	0.10	
3/8	HO-372-6FP	3/8-18	1.44	0.70	0.94	1.08	0.12	
1/2	HO-502-8FP	1/2-14	2.03	0.86	1.12	1.30	0.26	

NPSF – National Pipe Straight Fuel



### Features

- Parker DM Series offer double shut-off valving and push-to-connect operation in a small envelope size.
- They are constructed of nickel plated brass and are available in 1/8" body size only.
- Standard seals are Fluorocarbon, but other seal material is available upon request. See the Coupling Selection and Ordering Information Guide at the beginning of Section A and the Fluid Compatibility Chart at the end of this catalog for optional materials.

### Performance

DM Series (1/8")  
Test Fluid: Water

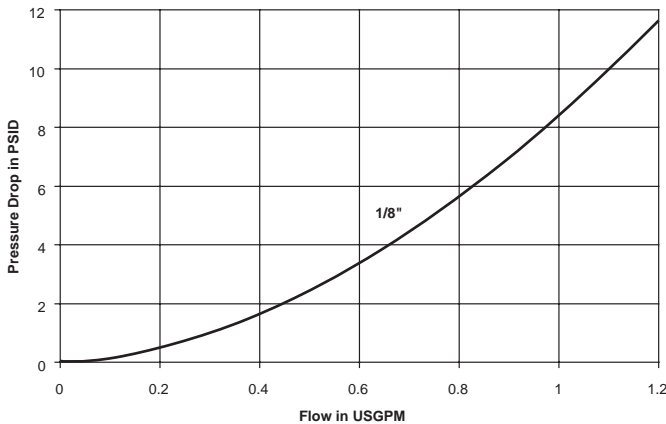

### Applications

Typical applications include dental equipment, lubrication equipment, fluid transfer and coolant lines.

### Specifications

Body Size (in.)	1/8"
Temperature Range	-15°F to +400°F
Rated Pressure	250 PSI
Locking Device	5 Balls
Rated Flow (GPM)	0.8

### How To Order

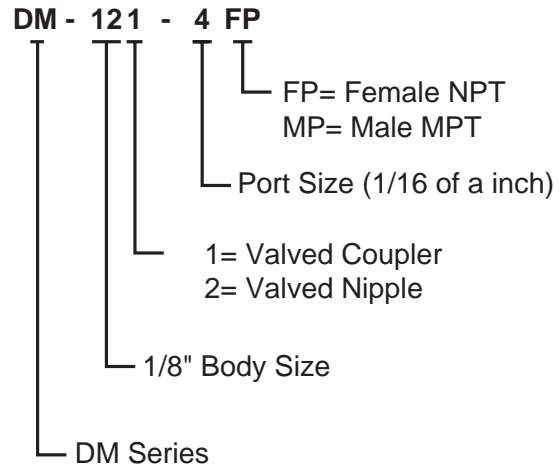

### Couplers

#### Female Pipe Thread

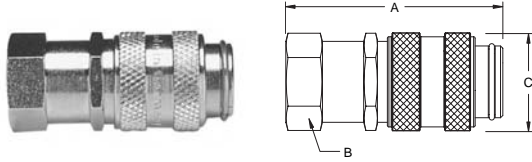

Body Size (in.)	New Part No.	Old Part No.	Thread Size NPTF	Dimensions (in.)			Largest Diameter	Wt. (LB)	P/Price
				Overall Length	Hex Size	Hex Size			
				A	B	C			
1/8	DM-121-2FP	CDM02-2-2Y	1/8-27	1.42	0.55	0.63	.06		
1/8	DM-121-4FP	CDM02-2-4Y	1/4-18	1.81	0.67	0.78	.10		

#### Male Pipe Thread

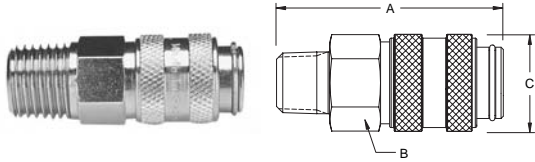

Body Size (in.)	New Part No.	Old Part No.	Thread Size NPTF	Dimensions (in.)			Largest Diameter	Wt. (LB)	P/Price
				Overall Length	Hex Size	Hex Size			
				A	B	C			
1/8	DM-121-2MP	CDM01-2-2Y	1/8-27	1.50	0.55	0.63	.06		
1/8	DM-121-4MP	CDM01-2-4Y	1/4-18	1.61	0.55	0.63	.07		

### Nipples

#### Female Pipe Thread

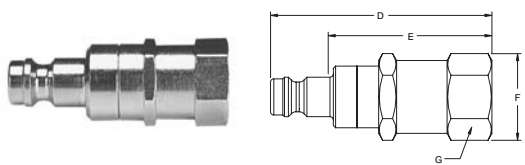

Body Size (in.)	New Part No.	Old Part No.	Thread Size NPTF	Dimensions (in.)				Largest Diameter	Wt. (lb)	P/Price
				Overall Length	Exposed Length*	Hex Size	Hex Size			
				D	E	F	G			
1/8	DM-122-2FP	NDM02-2-2Y	1/8-27	1.56	1.03	0.55	0.63	.05		
1/8	DM-122-4FP	NDM02-2-4Y	1/4-18	1.97	1.44	0.67	0.78	.09		

\* This dimension represents the portion that is exposed when a nipple is inserted into a Parker DM Series coupler.

#### Male Pipe Thread

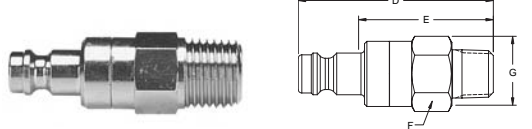

Body Size (in.)	New Part No.	Old Part No.	Thread Size NPTF	Dimensions (in.)				Largest Diameter	Wt. (lb)	P/Price
				Overall Length	Exposed Length*	Hex Size	Hex Size			
				D	E	F	G			
1/8	DM-122-2MP	NDM01-2-2Y	1/8-27	1.65	1.12	0.55	0.63	.05		
1/8	DM-122-4MP	NDM01-2-4Y	1/4-18	1.77	1.24	0.55	0.63	.06		

\* This dimension represents the portion that is exposed when a nipple is inserted into a Parker DM Series coupler.

## Applications

Parker offers a selection of dust plugs and caps for their hydraulic quick couplings. Most series shown in this section have a dust plug and cap specifically designed to be used with that style of coupling.

Dust plugs and caps serve a twofold function. They keep the mating surface clean and free of contamination and protect the critical mating elements of the coupling halves when they are disconnected. In this way the nipple is protected from damage that would make the total coupling unusable.

Protective dust plugs and caps play a crucial role in the use of quick couplings and no purchase of a hydraulic quick coupling is complete without the selection of an appropriate dust plug and cap. When ordering the dust cap/plug body size must correspond to that of the coupler or nipple.

Parker's full line of dust plugs and caps can be found below and on the following pages.

**Dust Plug:** Used on Coupler (female half)

**Dust Cap:** Used on Nipple (male half)

## Dust Plugs

### 60 Series



Body Size (in.)	Dust Plug Part No. Aluminum	Dust Plug Part No. Rubber	Dust Cap Part No. Aluminum	Dust Cap Part No. Rubber
1/8	H1-65	H1-65M	H1-66	H1-66M
1/4	H2-65	H2-65M	H2-66	H2-66M
3/8	H3-65	H3-65M	H3-66	H3-66M
1/2	H4-65	H4-65M	H4-66	H4-66M
3/4	H6-65	H6-65M	H6-66	H6-66M
1	H8-65	H8-65M	H8-66	H8-66M
1 1/2	H12-65	NA	H12-66	NA
2 1/2	H20P-65	NA	H20P-66	NA

NA = Not Available

### 6600 Series

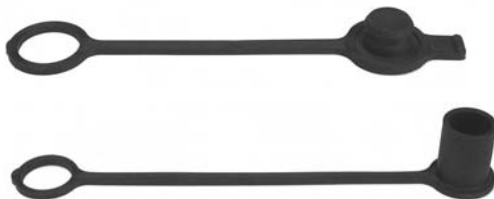

Body Size (in.)	Dust Plug Part No. Rubber	Dust Cap Part No. Rubber
1/4	H1-65M	H1-66M
3/8	TR-37	TR-37
1/2	5205-4M	5209-4M
3/4	6659-12M	6657-12M
1	6659-16M	6657-16M

### SM Series

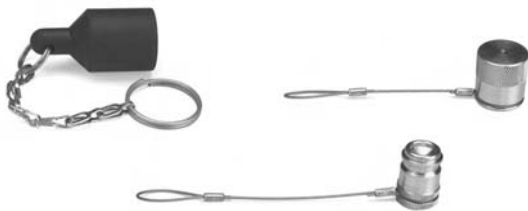

Body Size (in.)	Dust Plug Part No.	Dust Cap Part No.	Material
1/4	PL-25	N/A	Plastic
1/4	PR-25	CR-25	Rubber
1/4	P-25	C-25	Aluminum
1/2	DP-50	DC-50	Rubber
1/2	P-50	C-50	Aluminum
3/4	P-75	C-75	Aluminum

## Hydraulic Quick Couplings

## Dust Plugs and Dust Caps

### HP Series

Body Size (in.)	Dust Plug Part Number Aluminum	Dust Cap Part No. Aluminum
1	HPP-100	HPC-100
1 1/2	HPP-150	HPC-150

### 4000 Series & 5000 Series



Body Size (in.)	Dust Plug Part No. Steel	Dust Plug Part No. Rubber	Dust Cap Part No. Steel	Dust Cap Part No. Rubber
1/4	–	5205-2M*	–	5209-2M*
3/8	–	5205-3M*	–	5209-3M*
1/2	5005-4	5205-4M*	5009-4	5209-4M*
3/4	–	5205-5M*	–	5209-5M*
1	–	5205-6M*	–	5209-6M*

\* Designates all rubber material. (Not shown at left)

### NS Series



Body Size (in.)	Part Number Rubber
3/8	NR-37
1/2	NR-50
3/4	NR-75
1	NR-100

Protective cover fits either half.

### FF Series, FC Series, FH Series & FS Series



Body Size (in.)	Dust Plug Part Number Rubber	Dust Cap Part No. Rubber
1/4*	FR-25	FR-25
3/8	NR-50	NR-37
1/2	FR-501	FR-502
3/4	FR-751	FR-752
1	FR-1001	FR-1002

\* FR-25 fits both halves

### FEC Series, FEM Series



Body Size (in.)	Dust Plug Part Number Rubber	Dust Cap Part No. Rubber
1/4	FR-25	FR-25
3/8	NR-50	NR-37
1/2	FR-501	FER-502
3/4	FR-751	FER-752
1	FR-1001	

### 6100 Series



Body Size (in.)	Dust Plug Part No. Brass	Dust Cap Part No. Brass
3/4	6109-08	6108-08
1	6109-16	6108-16
1 1/4	6109-20	6108-20
1 1/2	6109-24	6108-24

**Dust Plugs and Dust Caps**

**Hydraulic Quick Couplings**

**9200 Series**



Body Size (in.)	Dust Cap. Part No. Rubber
1/2	9507-4-1

**3000 Series**



Body Size (in.)	Dust Plug Part No. Steel	Dust Cap Part No. Steel
1/4	3005-2	3009-2
3/8	3005-3	3009-3

**TC Series**



Body Size (in.)	Part Number Rubber
3/8	TR-37

Protective cover fits either half.

**HO Series**



**TR-37 Plug / Cap**



**DC-50**

Body Size (in.)	Used With HO Series Coupler/Nipple Part No.	Dust Plug Part No.	Dust Cap Part No.	Material
1/4	HO-251/252-4FP	TR-37	TR-37	Rubber
3/8	HO-371/372-6FP	TR-37	TR-37	Rubber
1/2	HO-501-8FP	DP-50	-	Rubber
1/2	HO-502-8FP	-	DC-50	Rubber

When ordering Parker coupler bodies and nipples, please state the part number of each type of coupler body and each type of nipple desired. List coupler bodies and nipples as separate items rather than in combinations. Be sure to double check thread or hose sizes of items required.

Many of Parker's coupling products are available with unique non-standard options well suited to very specific applications. Examples of unusual end use applications might include: high temperatures (above 250° F), extremely caustic/corrosive solutions passing through the coupling, external/environmental corrosion situations, or other high wear and tear situations such as dragging the product along the ground. Please see the Fluid Compatibility Chart at the end of the catalog for a guide in selecting material for various media. It is always recommended that the Quick Coupling Division be contacted with any questions concerning specific product application needs.

Typically, a prefix or suffix is added to the base part number to specify a non-standard O-ring seal, or special option such as a sleeve lock. The Optional Seals Suffix chart illustrates the designations.

Please Note: Certain couplings series have additional "Special Order Information" which should be referred to in ordering those products. If applicable to the product, "Special Order Information" is found next to the Features and Specifications charts.

Operation
<ul style="list-style-type: none"> <li>• Prefix "HD" for heavy duty nipple</li> <li>• Suffix "SL" for coupler sleeve-lok</li> <li>• Suffix "P" for poppet valve</li> <li>• Suffix "BP" for Push-lok hose barb</li> <li>• Suffix "VA" for Valve Actuator</li> </ul>

Optional Seals Suffix*				
No suffix is required when ordering products with the standard Nitrile seals. When specifying an optional seal, refer to the following chart to determine the appropriate suffix.**				
Coupling Series	Ethylene Propylene	Fluoro-carbon	Neoprene	Perfluoro-elastomer
60 Series	W	Y	Z	****
6600 Series	W	Y	Z	****
SM Series	E5	E4	E12	****
HP Series	E5	E4	E12	****
4000 Series	W	Y	Z	N/A
4200 Series	W	Y	Z	N/A
NS Series	E5	E4	N/A	****
FF Series Std. is E49	E5	E4	N/A	****
FH Series	E5	E4	N/A	****
FS Series	E5	STD	E12	****
6100 Series	W	Y	Z	N/A
5000 Series	W	Y	Z	N/A
8200 Series	W	Y	Z	N/A
9200 Series	W	Y	Z	N/A
3000 Series	Available with Polyurethane only (no suffix needed)			
TC Series	Available with Fluorocarbon only (no suffix needed)			
1141 Series	Available with Polyurethane only (no suffix needed)			
ST Series	W	Y	Z	
Water Service	Available with Nitrile only			
HO Series	E5	E4	E12	N/A
Moldmate Series Std. is Silicone	N/A	Y***	N/A	N/A

\*To select proper seal materials, see Fluid Compatibility Chart in Appendices section, or contact your Parker Quick Coupling Distributor.

\*\*N/A = Not Available; STD = Standard (No Suffix Needed)

\*\*\* Fluorocarbon seal available for use only with oil based media, not water glycol.

\*\*\*\* Contact the division for Perfluoroelastomer Seal Options.





**Description**

These popular coupling key chains are now available from the Quick Coupling Division. The new key chains are an anodized aluminum construction available in an array of colors. Key chains can be ordered using part numbers in the following chart.

<b>Part Number</b>	<b>Sleeve Color</b>
KEY-BK	Black
KEY-BU	Blue
KEY-GR	Green
KEY-RD	Red
KEY-CL	Clear
KEY-NI	Old style nickel plated